

Design Policy Manual

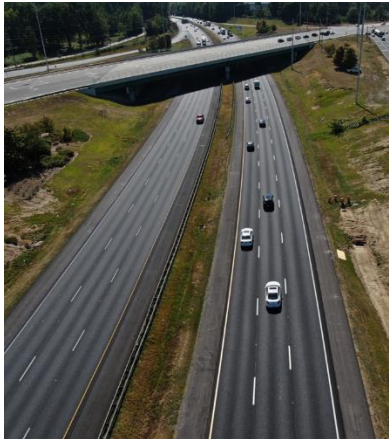

11/23/2020
Revision 6.2
Atlanta, GA 30308

This document was developed as part of the continuing effort to provide guidance within the Georgia Department of Transportation in fulfilling its mission to provide a safe, efficient, and sustainable transportation system through dedicated teamwork and responsible leadership supporting economic development, environmental sensitivity and improved quality of life. This document is not intended to establish policy within the Department, but to provide guidance in adhering to the policies of the Department.

Your comments, suggestions, and ideas for improvements are welcomed.

Please send comments to:

State Design Policy Engineer
Georgia Department of Transportation
One Georgia Center
600 W. Peachtree Street, 26th Floor
Atlanta, Georgia 30308

DISCLAIMER

The Georgia Department of Transportation maintains this printable document and is solely responsible for ensuring that it is equivalent to the approved Department guidelines.

Revision History

Revision Number	Revision Date	Revision Summary
1.0	5/12/06	Original Manual
2.0	5/21/07	General reformatting to provide a user-friendly online version
3.0	6/11/10	Editorial and formatting changes to Chapter 1-7 and the addition of Chapter 8, Roundabouts.
4.0	8/11/14	Reformatted manual to new standard template
4.1	8/25/14	<p>Removed list paragraphs throughout manual</p> <p>Chapter 3 - Added "Easement for Temporary Bridge Construction Access" to Section 3.8.3 Special Types of Right-of-Way</p> <p>Chapter 9 - Removed "FHWA Requirements for Curb Ramps" from Section 9.4.1; Added reference to Section 11.1 (ADA Requirement to Provide Curb Ramps) under "Curb Ramps" in Section 9.5.1; Added "Mid-Block Crossing" to Section 9.5.1</p> <p>Chapter 11 - Added "ADA Requirements to Provide Curb Ramps" to Section 11.1</p> <p>Chapter 14 - Updated Section 14.3.3 to include the 80' criteria from RP-22-11</p>
4.2	9/23/14	This edit updated the language in Section 9.5.1 that references Section 11.1.
4.3	10/7/14	<p>Chapter 4 – Added language to state that Design Exception is required if the State's superelevation rate cannot be met.</p> <p>Chapter 6 - Added language to discuss the use of method 1 temporary barrier for construction staging of a roadway.</p>
4.4	11/5/14	Chapter 4 - Removed the paragraph referring to the Department's org-chart from section 1.4. The chart is already mentioned in section 1.2.
4.5	11/21/14	Chapter 2 - Section 2.2 was updated to include the new email address for project managers and designers to electronically submit all design exceptions and design variances.
4.6	3/23/15	Chapter 11 - Added note to Table 11.1 regarding safety enhancement
4.7	5/11/15	<p>Acronyms and Definitions – Updated hyperlinks</p> <p>Chapter 1, 2, 3, 6, 7, 8, 9, 11, 13, 14 - Updated hyperlinks</p> <p>References – Updated hyperlinks</p>
4.8	6/5/15	Chapter 2 – Updated minor info

		<p>Chapter 3 - Updated Green Book info</p> <p>Chapter 4 - Removed statement requiring an exception for determining and locating superelevation runoff, runout and transitions. Updated Green Book info.</p> <p>Chapter 5 - Updated Green Book info.</p> <p>Chapter 6 - Changed "Interstate Medians" to "Freeway Median", 6.12.1. Updated Green book info</p> <p>Chapter 8 - The "SIDRA Standard" method environmental factors of the opening year and design year were changed.</p> <p>Chapter 9 - Added a reference in regards to FHWA has posted a new separated bike lane planning and design guide.</p>
4.9	6/19/15	Chapter 6 - Updated Curb and gutter method of construction
4.10	9/18/15	Chapter 3 – Updated Table 3.1 to correct line layout of Interstate/Freeway Ramp to have the word Ramp on a separate line.
4.11	1/5/16	<p>Chapter 4 – Deleted minor info</p> <p>Chapter 8 – Deleted contact info for safety assessments</p> <p>Chapter 9 – This chapter is a rewrite. Updated with new and current practice. Updated list of publications. The illustration of sidewalk along rural roadways was updated. Language regarding "structurally impractical" and "technically infeasible" for not meeting PROWAG requirements was added. A design criterion for bus loading pads was added. Language for bike lanes, intersections and connections between different bikeway types was added.</p> <p>Chapter 11 – Updated 11.1 title</p>
4.12	2/17/16	<p>Chapter 5</p> <p>5.2 Added a policy that all bridge columns should be protected regardless of median width.</p> <p>5.3 In addition to the minimum lateral offsets given in Table 5.3, the designer shall ensure there is a minimum of 1.5-ft from the face of curb to the face of tree at tree's mature growth.</p> <p>5.4 Relocated barrier section from chapter 6.11 to chapter 5.4.</p> <p>5.4.3 Added an end terminal selection flow chart.</p> <p>5.4.3 Added language for end treatments and crash cushion types.</p> <p>5.4.3 Developed a crash cushion selection flowchart.</p>

		<p>Chapter 6</p> <p>6.11 Removed chapter 6.11 barriers. This was relocated to chapter 5.4.</p> <p>6.13 Back-in angle parking was added as a preferred type of on-street parking.</p> <p>6.15 Added the requirement bicycle lanes should be 5-ft when adjacent to header curb, guardrail or other vertical surface. A 6-ft width bicycle lane should be used adjacent to a concrete barrier, where practical.</p> <p>6.15 Revised illustrations for clarity on the bikeable shoulder.</p> <p>Chapter 7 - Section 7.3 median opening spacing policy was updated to allow for flexibility on innovative intersections. The spacing may be closer if an operational study supports this finding.</p> <p>Chapter 11</p> <p>Updated chapter to current AASHTO Green Book & 2011 AASHTO Roadside Design Guide standards.</p> <p>Added language from the Roadside Safety Hardware announcement made on January 1, 2016. This is the implementation of MASH.</p> <p>11.1 Added the criteria that on alteration projects adjacent sidewalk must be upgraded (if needed).</p> <p>11.1 Added language that the omission of the installation of curb ramps or upgrade adjacent sidewalk shall require the prior approval of a Design Variance.</p> <p>Changed table 11.1 to match the memo sent to FHWA on 31Aug15.</p>
<p>4.13</p>	<p>5/6/16</p>	<p>Chapter 2 - Shoulder Width was added to the list of GDOT Standard Design Criteria.</p> <p>Chapter 5 - An illustration for the guidelines of w-beam guardrail placement was added. Minor changes in wording were made regarding high speed roadways. This change more aligns with wording in the AASHTO Green Book.</p> <p>Chapter 6 - Modifications were made on when 4% cross slope on a tangent section can be applied. It now requires an engineering study be placed in the project record when used. Shoulder Width for high volume high speed rural collectors and rural arterials was clarified as being a GDOT Standard Design Criteria. Minor changes in wording were made regarding high speed roadways. This change more aligns with wording in the AASHTO Green Book. Illustration of Typical Dimensions for Rural Freeway was added.</p> <p>Chapter 8 - Minor changes in wording were made regarding high speed roadways. This change more</p>

		aligns with wording in the AASHTO Green Book. Chapter 11 - An illustration of guardrail placement in areas with restricted right of way and limited shoulder width was added.
4.14	6/17/16	Chapter 14 – Revised entire Lighting procedures
4.15	7/21/16	<p>Acronyms and Definitions – Added new definitions</p> <p>Chapter 2 - Tangent Lengths on Reverse Curves with a design speed \geq 50 mph was added to the list of design variances. Table 2.1 Exception to Design Standards was added to clarify on when a design exception or design deviation is required.</p> <p>Chapter 3 - 3.2 The entire section regarding a design vehicle was updated. Clarification was made between a design vehicle and a check vehicle. An illustration for designing verses accommodating a vehicle was added. Oversize overweight need and accommodation was introduced.</p> <p>Chapter 4 – 4.2.2 Tangent Lengths on Reverse Curves with a design speed \geq 50 mph was added to the list of design variances. Section 4.3.2 PROWAG requirements and its effect on vertical alignment language was modified for clarification. The Vertical Profile Clearance Based on High Water Table was removed due to information is in the GDOT Drainage Manual. The Superelevation Rotation Points and Rotation Widths table was modified for consistency on the horizontal location of rotation point.</p> <p>Chapter 5 - Design exceptions and design variances were updated to reflect the change in policy from the FHWA Memorandum. Updated other minor info</p> <p>Chapter 6 - Design exceptions and design variances were updated to reflect the change in policy from the FHWA Memorandum. Updated other minor info.</p> <p>Chapter 11 - Design exceptions and design variances were updated to reflect the change in policy from the FHWA Memorandum. Updated other minor info,</p> <p>References - AASHTO, A Policy on Design Standards – Interstate System 2016 edition replaced the 2005 edition. Several IESNA publications were updated to the current editions.</p>
4.16	9/13/16	Chapter 4 – Corrected Design Speed in Table 4.10 Chapter 9 – Added reference to Design Reference
4.17	9/29/16	Chapter 3 – Updated Design Vehicles procedures Chapter 4 – Updated minor info
4.18	1/20/17	Chapter 6 – Updated pedestrian crossings info. Added reference to Pedestrian Streetscape Guide and Public Rights-of-Way

		<p>Chapter 7 – Added reference to Pedestrian Streetscape Guide and Public Rights-of-Way Accessibility Guidelines manual</p> <p>Chapter 9 – Added reference to Public Rights-of-Way Accessibility Guidelines manual</p>
4.19	4/4/17	<p>Chapter 7 – Updated PROWAG hyperlink. Section 7.3 Clarification was made on intersection control for median openings on six-lane roadways.</p> <p>Chapter 13 – Revised sections 13.1 and 13.2 to reference Traffic Forecasting Manual. Added definition of Design Hour Volume (DHV), Annual Average Daily Traffic (AADT), Peak Hour Volume (PHV) and Design Year. Deleted section 13.6.</p>
4.20	4/18/17	<p>Chapter 4 - Added example that decision sight distance should be considered at six-lane roadways with at-grade intersections.</p> <p>Chapter 6 - A decision to use a noise wall material other than precast concrete panels or interlocking steel panels, where a lighter material is necessary, will require written approval from the GDOT Chief Engineer.</p>
4.21	6/1/17	<p>Acronyms and Definitions – Updated Work zone definition</p> <p>Chapter 3 – Section 3.5.2 Consideration for breaks in access will follow the newly outlined procedures in chapter 6 of the PDP.</p>
4.22	8/22/17	<p>Chapter 9 - Bicycle Warrants were removed for all new and widened bridges.</p> <p>Bicycle warrants were removed on retained bridges where a bridge deck is being replaced or rehabilitated and the existing bridge width allows for a wide enough shoulder for bike accommodations (i.e. greater than or equal to 5 ft) without eliminating (or precluding) needed pedestrian accommodations.</p> <p>Clarified where a bike warrant is met, the appropriate type of accommodation should be determined using the AASHTO, Guide for the Development of Bicycle Facilities.</p> <p>Added On retained bridges where a bridge deck is being replaced or rehabilitated on a highway which bicycles are permitted to operate at each end, reference Title 23 United States Code, Chapter 2, Section 217, Part (e) for requirements.</p> <p>Added bicycle and pedestrian warrant exclusion for routes on which they are specifically not allowed.</p> <p>Added Figure 9.9 Illustration of Shared Use Path on Bridge Structure Minimum Dimensions.</p>
4.23	10/3/17	<p>Chapter 2 – Deleted Bridge and Structural Manual from Design Criteria. Added new section 2.2.3 Design Variances for Off-System Roadway.</p> <p>Updated Table 2.1 Exception to Design Standards</p>

4.24	10/24/17	Chapter 6 - Rumble strip placement has been updated to reflect the change in GDOT Details. Requirements on when to apply edge lines has been added. Rumble strip placement will now be required for 40 mph or greater roadways.
4.25	12/4/17	Chapter 4 – Section 4.1.6 - Updated info regarding sharp angle turns. Added policy Intersection Control Evaluation (ICE) and FHA Diverging Diamond Interchange Informational info
5.0	12/22/17	Chapter 2 – Added Access Control to GDOT Standard Criteria in Table 2.1 Chapter 10 – Added info regarding Pavement Design
5.1	3/8/18	Chapter 10 – Updated Design Resources references Chapter 11 – Updated info regarding bicycle warrants. Replaced Figure 11.2
5.2	4/6/18	Chapter 3 – Removed (min) references from Table 3.1 Chapter 8 - Updated to include the Intersection Control Evaluation (ICE) Policy. Updates provides the Design Engineer with guidance for the design and review of roundabouts in the state of Georgia, as it relates to the ICE Policy. Chapter 11 – Updated guardrail repair requirements. Table 11.1 changed NCHRP 350 references to MASH Chapter 14 - Section 14.3.8 was revised from Minor (Permitted) Lighting to Permitted Lighting. Any reference to four or less luminaires was removed to reduce confusion.
5.3	4/24/18	Chapter 9 – Added references to the state code giving GDOT the ability to design limited-access roadways and regulate controlled-access roadways within jurisdiction. Table and figures representing the minimum dimensions for shared-use-path options across bridges with respect to the design speed, functional classification of the roadway, and the physical constraints between the bridge barriers/parapets was also added. Chapter 11 – Section 11.1.2 Added minor info to retained bridges
5.4	6/18/18	Chapter 3 – Added new section Easement for Maintenance of Retaining Walls Chapter 7 – Section 7.6 - Updated Railroad Crossing Improvement Office hyperlink and information. Deleted info regarding train activated warning devices info. Updated FHWA Traffic Control Devices hyperlink. Section 7.6.7 - Updated Adjustment Factor for School Buses

		<p>Chapter 9 – Correct Special Provision section numbering. Changed from 150.02-K to 150.1.04-C. Deleted information regarding multi-use path from Shared Use Paths</p> <p>Chapter 10 – Section 10.10.2 - Deleted reference regarding aggregate surface course and replaced with asphalt for earth. Replaced dirt drives with gravel drives</p>
5.5	7/9/18	<p>Updated GDOT logo throughout</p> <p>Chapter 14 - Removed the years from list of references.</p> <p>Added the AASHTO Roadway Lighting Design Guide to the list of references.</p> <p>Section 14.3.5: added Maximum Veiling Luminance to the requirements for the photometric review submittal.</p> <p>Added a note in the High Mast Tower section pertaining to bat habitat ESAs.</p> <p>Added clarification on the daytime lighting requirement for tunnels and underpasses.</p> <p>Revised Section 14.3.3. Roundabouts and Intersections.</p> <p>Miscellaneous grammatical revisions.</p>
5.6	9/6/18	<p>Chapter 10 – Section 10.6.2 changed design considerations from the Guidelines for Superpave and Other Mix Types Selections to Criteria for Use of Asphaltic Concrete Layer and Mix Types</p> <p>Chapter 11 – Section 11.1.1 added information regarding Rumble Strips and new table 11.2 Rumble Strip Placement.</p> <p>Updated table numbers throughout.</p> <p>Figure 11.2 Changed AASHTO Minimum Barrier Placement with 8-ft post to AASHTO Minimum Barrier Placement with 7-ft post.</p>
5.7	11/15/18	<p>Chapter 5 – Replaced Figure 5.3</p> <p>Chapter 10 - Section 10.6.3 Constructability. Changed "permanent" pavement is to "temporary".</p> <p>Chapter 11 – Values in Table 11.3 were updated to new Green Book Standard. Bridge information tables were removed and referenced to Green Book, and Bridge and Structural Design Manual for guidance. Sidewalk repair was removed</p> <p>Chapter 14 - Revised Section 14.3.4 - Vehicular Underpass/Tunnel to provide clarification on tunnel lighting recommendations based on the updated AASHTO Roadway Lighting Design Guide.</p>
5.8	12/21/18	<p>Chapter 3 - Addition of section 3.5.3 Right of Way and Limit of Access Line Descriptions. Addition of</p>

		<p>figure 3.2 Limit of Access Control - Line Descriptions. Update on reference to GDOT Bridge and Structures Manual for "design and installation of fence and handrail on bridges". Updates related to the new Green Book where applicable.</p> <p>Chapter 4 - Updates related to the new Green Book criteria. Intersection Skew angle criteria changed from 70 to 75 degrees to be consistent with the new Green Book. Update of table 4.5 Maximum Vertical Grades.</p> <p>Chapter 6 - Updates throughout the chapter to match information with the new Green Book. Tables 6.4, 6.5 updated to match new Green Book criteria</p> <p>Chapter 7 - Updates throughout the chapter to match with new Green Book information</p> <p>Chapter 8 - Section 8.2.6. Public involvement process reworded for clarity.</p> <p>Chapter 10 – Added reference Guidelines for Capital Maintenance Projects to 10.2 Design Resources</p> <p>Chapter 11 - Text on page 11-12 was corrected to reference table 11-4.</p> <p>Chapter 14 - Revised the language for the Lump Sum (LS) Lighting Program. Added guidance for lighting at mini-roundabouts. Revised Section 14.4.4 to add clarification on metered and non-metered systems. Miscellaneous grammatical revisions.</p> <p>Reference Chapter - Updated references to new Green Book.</p>
<p>5.9</p>	<p>5/7/19</p>	<p>Chapter 6 - Added a section regarding the appropriate usage of header curb and offsets on State Routes and NHS roadways. Added language regarding the consideration of usage for 4-ft wide flush medians.</p> <p>Chapter 8 - Removed the requirement for peer reviews and other minor changes.</p> <p>Chapter 9 – Minor update to section number</p> <p>Chapter 10 - Changed the language to approval by the State Pavement Engineer instead of the Pavement Design Committee. Changed and added references for design resources. Changed the minimum temporary pavement structure. This reflects the new criteria for mix designs that was published in 2018. Truck percentage was dropped in favor of AADTT. Other minor changes were made.</p> <p>Chapter 12 - New chapter that purpose is to provide general design guidance and typical practices for developing stage construction plans.</p>

<p>5.10</p>	<p>5/31/19</p>	<p>Chapter 14 - Updated list of references. Updated chapter based on the updated IES RP-8. Added section for toll plazas.</p> <p>Reference – Updated references</p>
<p>5.11</p>	<p>7/3/19</p>	<p>Chapter 10 - Minor formatting and reference changes throughout the chapter.</p> <p>10.3.2: Clarification was made that +2 designs are to be included in the Pavement Design Package.</p> <p>10.6.2: The new underdesign policy based on SR priority was updated.</p> <p>10.6.3 Temporary Pavement: Reference was added to the new target based on revised underdesign policy.</p> <p>10.10.2 Driveways: Specified recycled asphalt concrete 9.5 mm Superpave Type II for standard use</p>
<p>5.12</p>	<p>8/28/19</p>	<p>Chapter 3 - Corrected spellings and hyperlinks corrections were made in section 3.2.3</p>
<p>5.13</p>	<p>10/29/19</p>	<p>Chapter 5 – 5.4.3 updated AASHTO Manual for Assessing Safety Hardware reference</p> <p>Chapter 8</p> <p>8.2.4 – corrected table reference and updated Illuminating Engineering Society (IES) reference. Changed</p> <p>8.4.1 – updated IES reference and hyperlink</p> <p>8.4.2 – updated references and hyperlinks</p> <p>Chapter 13 – Updated Table 13.2</p> <p>Chapter 14 - Section 14.3.3. Intersections and Roundabouts. Changed from “Table 12.2 & 12.2” to “Table 12.1 & 12.2”.</p> <p>References – Updated publications references</p>
<p>6.0</p>	<p>6/8/20</p>	<p>Updated template to comply with corporate branding guidelines</p> <p>Version number for all sections were all updated to 6.0 to reflect the overall manual version number</p> <p>Chapter 2 - Section 2.1.2 corrected NATCO to NACTO</p> <p>Chapter 4 - Section 4.3.2: Removed max vertical grades exceptions listed in Chapter 4 and redirected to AASHTO</p> <p>Chapter 5 - 5.4.1 Updated statement regarding guardrail placement behind curb face.</p> <p>Chapter 6</p> <p>6.14.2: Updated guidance for guardrail placement in front of noise wall</p>

		<p>6.14.4: Removed reference to previous LRFD manual and removed vehicular collision design. Updated to reference Bridge Design Manual</p> <p>Chapter 12 - Section 12.4.8.2: Updated guidance regarding minimum offset between existing and proposed bridge during staged construction.</p> <p>Reference</p> <p>Reference Publication:</p> <ul style="list-style-type: none"> - Corrected NATCO to NACTO on both list and under images. - Updated note next to AASHTO. Standard Specifications for Highway Bridges, 17th Edition. 2002. - Added AASHTO LRFD Image and title. Updated corresponding note.
<p>6.1</p>	<p>8/24/20</p>	<p>Chapter 2</p> <p>Section 2.2.1: Added guidance regarding design exceptions for connecting roadways to high-speed NHS facilities.</p> <p>Table 2.1: Added note to reflect guidance regarding design exceptions for connecting roadways to high-speed NHS facilities.</p> <p>Chapter 4</p> <p>Section 4.3.2: – Corrected guidance regarding grade of pedestrian access at pedestrian street crossings.</p> <p>Chapter 6</p> <p>Minor corrections to DPM and Pedestrian Streetscape Guide references throughout chapter. Revised figure numbering throughout.</p> <p>Section 6.9: Updated guardrail standard and contact for 2' curb and gutter standard. Added figure 6-4a and 6-4b and additional guidance for raised island design.</p> <p>Section 6.12: Minor updates to language throughout section. Updated contact for special noise wall detail.</p> <p>Table 6.4, 6.5, and 6.6: Revised ditch bottom width for several columns. Revised note 1 to address current criteria for roadways <2000 ADT. Updated GDOT Structures Manual note. Removed note 1 for arterial roadways in Table 6.6.</p> <p>Chapter 9</p> <p>Section 9.1: Added Bikeway Selection guide as a design reference.</p> <p>Section 9.5: Minor changes with language in regard to PROWAG design criteria.</p>

6.2	11/23/20	Chapter 14 Deleted Section 14.5.1. Proprietary Items and Use of Force Accounts Miscellaneous grammatical revisions
-----	----------	---

Intentionally Left Blank

List of Effective Chapters

Document	Revision Number	Revision Date
List of Effective Chapters	6.2	11/23/20
Table of Contents	6.2	11/23/20
Acronyms and Definitions	6.0	6/8/20
Chapter 1. Introduction	6.0	6/8/20
Chapter 2. Design Policy Guidelines and Standards	6.1	8/24/20
Chapter 3. Design Controls	6.0	6/8/20
Chapter 4. Elements of Design	6.1	8/24/20
Chapter 5. Roadside Safety and Lateral Offset to Obstructions	6.0	6/8/20
Chapter 6. Cross Section Elements	6.1	8/24/20
Chapter 7. AT Grade Intersections	6.0	6/8/20
Chapter 8. Roundabouts	6.0	6/8/20
Chapter 9. Complete Streets	6.1	8/24/20
Chapter 10. Pavement Design	6.0	6/8/20
Chapter 11. Other Project Types	6.0	6/8/20
Chapter 12. Stage Construction	6.0	6/8/20
Chapter 13. Traffic Studies	6.0	6/8/20
Chapter 14. Lighting	6.1	11/23/20
References	6.0	6/8/20

Intentionally Left Blank

Table of Contents

Revision History	i
List of Effective Chapters	xiii
Table of Contents.....	xv
Acronyms and Definitions	xxv
Acronyms.....	xxv
Definition of Terms.....	xxix
Chapter 1. Introduction - Contents	1-i
1.1 Purpose	1-1
1.2. Organization	1-1
1.3. Contact	1-1
1.4. Manual Updates.....	1-2
1.5. Project Review and Submission Requirements.....	1-2
1.6. Acknowledgements.....	1-2
Chapter 2. Design Policy Guidelines and Standards - Contents.....	2-i
2.1 General Design Policy Information.....	2-1
2.1.1. Definitions.....	2-1
2.1.2. Sources of Design Policy and Practice.....	2-3
2.2 Exception to Design Standards.....	2-4
2.2.1. Design Exception.....	2-4
2.2.2. Design Variance	2-4
2.2.3 Design Variances for Off-System Roadway	2-5
2.3 Context Sensitive Design.....	2-7
Chapter 3. Design Controls - Contents.....	3-i
3.1. Functional Classification	3-1
3.2 Design Vehicles	3-5
3.2.1. Design VEHICLE Types	3-6
3.2.2. Local Input for Selecting a Design Vehicle	3-7
3.2.3. Special Roadways and Networks.....	3-8
3.2.4 Design Vehicle Turning Paths.....	3-9
3.2.5 Design Vehicles and Pedestrians.....	3-9
3.2.6. Accommodation of OSOWs	3-9
3.3. Design Speed	3-10
3.3.1. General Considerations	3-10
3.3.2. Intersections Approaching a Stopped Condition.....	3-10

- 3.3.3. Freeway Exit and Entrance Ramps..... 3-10
- 3.3.4. Urban Subdivision Streets..... 3-11
- 3.4. Highway Capacity 3-11
- 3.5. Establishment of Access Control..... 3-11
 - 3.5.1. Definitions..... 3-11
 - 3.5.2. Access Management 3-12
 - 3.5.3. Right of Way (R/W) and Limit of Access (L/A) Line Descriptions..... 3-15
- 3.6. Frontage Roads and Access Roads..... 3-16
- 3.7. Fencing..... 3-17
 - 3.7.1 Fencing on State Right-of-Way 3-17
 - 3.7.2 Fencing on Private Property..... 3-19
- 3.8. Right-of-Way Controls..... 3-19
 - 3.8.1. Rural Areas..... 3-20
 - 3.8.2. Urban Areas 3-20
 - 3.8.3. Special Types of Right-of-Way..... 3-20
 - 3.8.4. Accommodating Utilities..... 3-21
- 3.9. Value Engineering..... 3-22
- 3.10. Environmental 3-22
- Chapter 4. Elements of Design - Contents 4-i
- 4.1 Sight Distance..... 4-1
 - 4.1.1. General Considerations 4-1
 - 4.1.2. Stopping Sight Distance..... 4-1
 - 4.1.3. Passing Sight Distance 4-2
 - 4.1.4. Decision Sight Distance 4-2
 - 4.1.5. Intersection Sight Distance 4-2
 - 4.1.6. Intersection Skew Angle 4-3
- 4.2 Horizontal Alignment..... 4-4
 - 4.2.1. Theoretical and General Considerations 4-5
 - 4.2.2. Types of Curves..... 4-6
 - 4.2.3. Pavement Widening on Curves..... 4-9
 - 4.2.4. Lane Width Transitions and Shifts..... 4-10
 - 4.2.5. Transition in Number of Lanes 4-12
- 4.3 Vertical Alignment..... 4-14
 - 4.3.1. General Considerations for Vertical Alignments 4-15
 - 4.3.2. Maximum Vertical Grades..... 4-16
 - 4.3.3. Minimum Vertical Grades..... 4-18
 - 4.3.4. Vertical Curves 4-20

- 4.3.5. Maximum Change in Vertical Grade without Using Vertical Curves 4-21
- 4.3.6. Vertical Grade Changes at Intersections..... 4-22
- 4.3.7. Minimum Profile Elevation Above High Water 4-22
- 4.3.8. Reporting Changes in Vertical Clearances..... 4-23
- 4.4 Combined Horizontal and Vertical Alignments 4-24
 - 4.4.1. Aesthetic Considerations 4-24
 - 4.4.2. Safety Considerations..... 4-24
 - 4.4.3. Divided Highways 4-25
- 4.5 Superelevation..... 4-26
 - 4.5.1. Superelevation Rate 4-26
 - 4.5.2. Sharpest Curve without Superelevation 4-28
 - 4.5.3. Axis of Rotation..... 4-28
 - 4.5.4. Superelevation Transitions..... 4-29
- Chapter 5. Roadside Safety and Lateral Offset to Obstruction - Contents 5-i
 - 5.1 Overview..... 5-1
 - 5.2 Lateral Offset to Obstruction 5-2
 - 5.2.1 Rural Shoulders 5-2
 - 5.2.2 Urban Shoulders..... 5-3
 - 5.3 Lateral Offsets for Roadside Features..... 5-4
 - 5.3.1. Sign Supports 5-4
 - 5.3.2 Lighting Standards..... 5-4
 - 5.3.3. Utility Installations 5-5
 - 5.3.4 Signal Poles and Signal Cabinets 5-6
 - 5.3.5 Trees and Shrubs 5-7
 - 5.4. Roadside Safety Hardware 5-8
 - 5.4.1. Barrier Types 5-8
 - 5.4.2. Barrier Location & Application 5-10
 - 5.4.3. End Treatments 5-12
- Chapter 6. Cross Section Elements - Contents 6-i
 - 6.1 Lane Width 6-1
 - 6.2. Pavement Type Selection 6-1
 - 6.3. Cross Slope 6-1
 - 6.4. Pavement Crowns..... 6-1
 - 6.5. Shoulders 6-2
 - 6.5.1. Rumble Strips 6-3
 - 6.5.2. Pavement Edge Treatment 6-4
 - 6.6. Side Slopes..... 6-5

- 6.7. Border Area (urban shoulder) 6-6
- 6.8. Bike Lanes..... 6-6
- 6.9. Curbs..... 6-6
 - 6.9.1. Curb Types 6-8
 - 6.9.2. Methods of Construction 6-9
 - 6.9.3. Raised Median Noses..... 6-10
 - 6.9.4. Raised Channelizing Islands..... 6-10
- 6.10. Sidewalks 6-12
- 6.11. Barriers 6-12
- 6.12. Medians 6-12
 - 6.12.1. Freeway Medians 6-13
 - 6.12.2. Arterial Medians..... 6-13
 - 6.12.3. Medians at Pedestrian Crossings..... 6-15
- 6.13. Parking Lanes 6-15
- 6.14. Noise Barriers 6-16
 - 6.14.1. The Environmental Process 6-16
 - 6.14.2. Design of Noise Walls..... 6-17
 - 6.14.3. Construction Plan Requirements..... 6-19
 - 6.14.4. Construction 6-20
- 6.15. Summary of Design Criteria for Cross Section Elements 6-20
- Chapter 7. AT Grade Intersections - Contents..... 7-i
 - 7.1. Intersection Design Elements 7-1
 - 7.2. Intersection Geometrics 7-1
 - 7.2.1. Angle of Intersection/Skew Angle..... 7-1
 - 7.2.2. Right-of-Way Flares..... 7-1
 - 7.2.3. Turn Lanes 7-2
 - 7.2.4. Islands..... 7-2
 - 7.2.5. Intersection Radii 7-3
 - 7.3. Median Openings..... 7-3
 - 7.4. Driveways 7-4
 - 7.5. Signalization 7-5
 - 7.5.1. New Intersections and Existing Unsignalized intersections 7-6
 - 7.5.2. Signal Modification..... 7-7
 - 7.5.3. Geometric Design Elements 7-7
 - 7.6. Highway-Railroad Grade Crossings 7-8
 - 7.6.1. Horizontal Alignment..... 7-8
 - 7.6.2. Vertical Alignment..... 7-9

- 7.6.3. Highway-Rail Grade Traffic Control Considerations 7-9
- 7.6.4. Traffic Control Devices..... 7-11
- 7.6.5. Alternatives to Maintaining the Crossing 7-12
- 7.6.6. Crossing Consolidation and New Crossings 7-13
- 7.6.7. GDOT At-Grade Highway-Rail Crossing Evaluation Criteria 7-13
- Chapter 8. Roundabouts - Contents..... 8-i
- 8.1. Introduction..... 8-1
- 8.2. Roundabout Validation..... 8-1
 - 8.2.1. ICE Stage 1 – Screening 8-2
 - 8.2.2. ICE Stage 2 – Alternative Selection 8-5
 - 8.2.3. Concept Validation Requirements of Roundabouts 8-5
 - 8.2.4. Lighting..... 8-6
 - 8.2.5. Public Involvement..... 8-7
- 8.3. Design Guidelines..... 8-8
 - 8.3.1. Review of Construction Plans 8-9
 - 8.3.2. Design Vehicle..... 8-9
 - 8.3.3. Alignment of Approaches 8-9
 - 8.3.4. Splitter Islands 8-9
 - 8.3.5. Pedestrian Accommodations 8-10
 - 8.3.6. Bicycle Accommodations 8-10
 - 8.3.7. Treatments for High Speed Approaches 8-10
 - 8.3.8. Drainage..... 8-11
 - 8.3.9. Curbing..... 8-11
 - 8.3.10. Pavement 8-11
 - 8.3.11. Staging of Improvements 8-11
 - 8.3.12. Traffic Control Devices..... 8-12
 - 8.3.13. Landscaping 8-12
 - 8.3.14. Construction..... 8-12
- 8.4. References 8-13
 - 8.4.1. Primary References 8-13
 - 8.4.2. Additional References..... 8-13
- 8.5. Definitions..... 8-14
 - 8.5.1. Roundabout Physical Features 8-14
 - 8.5.2. Roundabout Glossary of Terms 8-17
- Chapter 9. Complete Streets Design Policy - Contents 9-i
- 9.1. Overview..... 9-1
 - 9.1.1. Principles 9-2

- 9.1.2. References 9-3
- 9.1.3. Definition of Accommodation 9-5
- 9.2. Typical Users & Needs 9-6
 - 9.2.1. Pedestrians..... 9-6
 - 9.2.2. Bicyclists..... 9-6
 - 9.2.3. Transit Users 9-7
 - 9.2.4. Needs and Volumes..... 9-7
- 9.3. User Networks 9-7
 - 9.3.1. Pedestrian Networks..... 9-7
 - 9.3.2. Bicycle Networks 9-10
 - 9.3.3. Transit Networks..... 9-15
- 9.4. Warrants for Accommodation..... 9-16
 - 9.4.1. Pedestrian Warrants 9-16
 - 9.4.2. Bicycle Warrants..... 9-17
 - 9.4.3. Transit Warrants 9-18
 - 9.4.4. Exclusions 9-18
- 9.5. Design of Accommodations 9-19
 - 9.5.1. Pedestrian Accommodation Design 9-19
 - 9.5.2. Bicycle Accommodation Design 9-28
 - 9.5.3. Transit Accommodation Design 9-35
- 9.6. Acknowledgements..... 9-35
- Chapter 10. Pavement Design - Contents 10-i
 - 10.1 Overview..... 10-1
 - 10.2 Design Resources..... 10-1
 - 10.3 Design Considerations 10-1
 - 10.3.1 Design Period 10-1
 - 10.3.2 Traffic Volume Projections 10-2
 - 10.3.3 Pavement Structure and Type Changes 10-2
 - 10.3.4 Pavement Subgrade 10-6
 - 10.3.5 Pavement Widening..... 10-6
 - 10.3.6 Pavement Base 10-7
 - 10.3.7 Pavement Approval/Re-approval 10-8
 - 10.3.8 Cross Road Design..... 10-8
 - 10.4 Alternate Pavement Bid Process..... 10-9
 - 10.4.1 Introduction..... 10-9
 - 10.4.2 Design & Construction Plan Requirements 10-9
 - 10.4.3 Mainline Travel Lane Alternates..... 10-10

- 10.4.4 Paved Shoulder Alternates 10-10
- 10.4.5 Base Alternates 10-10
- 10.4.6 Quantities & AASHTO Transport Construction Estimate System (CES)..... 10-10
- 10.5 Rigid Pavement 10-10
 - 10.5.1 Introduction 10-10
 - 10.5.2 Design Considerations..... 10-11
 - 10.5.3 Constructability 10-11
- 10.6 Flexible Pavement 10-13
 - 10.6.1 Introduction 10-13
 - 10.6.2 Design Considerations..... 10-14
 - 10.6.3 Constructability 10-15
- 10.7 Composite Section..... 10-16
- 10.8 Shoulders 10-16
 - 10.8.1 Introduction 10-16
 - 10.8.2 Design Considerations..... 10-16
 - 10.8.3 Curb and Gutter 10-16
- 10.9 Roundabouts 10-16
- 10.10 Driveways and Parking Areas..... 10-17
 - 10.10.1 Design Considerations..... 10-17
 - 10.10.2 Standard Pavement Structure..... 10-17
- Chapter 11. Other Project Types - Contents 11-i
 - 11.1. Preventative Maintenance (PM), Resurfacing, Restoration, or Rehabilitation (3R), and Pavement Reconstruction Guidelines for Federal Aid Projects 11-1
 - 11.1.1. Procedures and Guidelines..... 11-4
 - 11.1.2. Controlling Criteria for Non-Interstate Systems (GDOT 3R Standards) 11-9
 - 11.1.3. Other Design Considerations for 3R Projects (GDOT 3R Standards)..... 11-13
 - 11.2. Special Design Considerations for Other Project Types 11-16
 - 11.2.1. Bridge Fencing Projects 11-16
 - 11.2.2. Bridge Jacking Projects 11-16
 - 11.2.3. Intelligent Transportation System (ITS) Projects 11-17
 - 11.2.4. Signing & Marking Projects 11-17
 - 11.2.5. Traffic Signal Projects 11-17
 - 11.2.6. Noise Abatement Projects..... 11-18
 - 11.3. Design Elements for Other Project Types..... 11-18
 - 11.3.1. Survey Requirements 11-18
 - 11.3.2. Construction Plans..... 11-20
 - 11.3.3. Pavement Design 11-20

- 11.3.4. Environmental..... 11-20
- 11.3.5. Earthwork 11-20
- 11.3.6. Drainage..... 11-21
- 11.3.7. Guardrail and/or Barrier 11-21
- 11.3.8. Erosion Control Plans 11-23
- 11.3.9. Traffic Signal Plans..... 11-23
- 11.3.10. Signing & Markings..... 11-23
- 11.3.11. Utilities..... 11-23
- 11.3.12. Traffic Control Plans 11-23
- 11.4. Safe Routes to Schools (SRTS) Projects..... 11-23
 - 11.4.1. SRTS References..... 11-24
 - 11.4.2. SRTS Procedures and Guidelines 11-24
- Chapter 12. Stage Construction - Contents..... 12-i
 - 12.1. Overview 12-1
 - 12.1.1 Principles 12-1
 - 12.1.2. References 12-1
 - 12.2 Project Types..... 12-3
 - 12.2.1. General..... 12-3
 - 12.2.2. When are Staging Plans Normally Required? 12-3
 - 12.2.3. When are Staging Plans Normally Not Needed?..... 12-4
 - 12.3. Plan Development Requirements 12-4
 - 12.3.1. Concept Report..... 12-4
 - 12.3.2 Preliminary Plans..... 12-6
 - 12.4 Design Considerations..... 12-11
 - 12.4.1. Earthwork 12-11
 - 12.4.2. Drainage..... 12-11
 - 12.4.3. Erosion and Sediment Control 12-12
 - 12.4.4. Pavement 12-12
 - 12.4.5. Temporary Concrete Barriers and End Treatments..... 12-13
 - 12.4.6. Traffic Control 12-14
 - 12.4.7. Utilities..... 12-16
 - 12.4.8. Structures 12-17
 - 12.4.9. Post-construction BMP's/Water Quality Features..... 12-18
 - 12.4.10. Lighting 12-18
 - 12.4.11. Railroads..... 12-18
 - 12.4.12. Common Problems..... 12-19
 - 12.5. Acknowledgements 12-19

Chapter 13. Traffic Studies - Contents	13-i
13.1. Traffic Data.....	13-1
13.2 Traffic Projections	13-1
13.3. Trip Generation and Assignment for Traffic Impact Studies	13-1
13.3.1. Trip Generation.....	13-1
13.3.2. Traffic Assignment	13-4
13.4. Freeway Capacity and Design.....	13-5
13.4.1. ITS Technology.....	13-5
13.4.2. Capacity Analysis and Level of Service.....	13-5
13.4.3. Ramps and Ramp Junctions	13-8
13.4.4. Traffic Management Strategies	13-9
13.5 Arterial Capacity and Design.....	13-12
13.5.1. Capacity Analysis and Level of Service (LOS)	13-12
13.5.2. Traffic Analysis Procedures	13-12
13.5.3. Intersection Traffic Control and Design	13-13
Chapter 14. Lighting - Contents	14-i
14.1. Overview	14-1
14.1.1. Applicable References	14-1
14.2. General Considerations	14-1
14.2.1. Project Types.....	14-1
14.2.2. Warranting Conditions	14-2
14.2.3. Existing Lighting Systems	14-3
14.2.4. Lighting Agreements.....	14-3
14.3. Illumination Requirements	14-4
14.3.1. Design Considerations.....	14-4
14.3.2. Continuous Roadway.....	14-7
14.3.3. Intersections and Roundabouts	14-7
14.3.4. Vehicular Underpasses/Tunnels	14-8
14.3.5. Pedestrian facilities	14-9
14.3.6. Parking Facilities.....	14-10
14.3.7. Toll Plazas	14-10
14.3.8. Aesthetic Lighting	14-10
14.3.9. Permitted Lighting.....	14-10
14.4. Design Criteria.....	14-10
14.4.1. Photometric Submittals	14-10
14.4.2. Light Standard Location	14-11
14.4.3. Structural Requirements	14-12

14.4.4. Power Service.....	14-12
14.4.5. Electrical Design	14-13
14.4.6. Grounding.....	14-15
14.5. Material Requirements	14-15
14.5.1. Luminaires	14-15
14.5.2 Electrical Materials.....	14-15
References	1

Acronyms and Definitions

Acronyms

3R – Roadway Resurfacing, Restoration, or Rehabilitation (Project)

A/C – Access Control

AADT – Average Annual Daily Traffic

AAWT – Average Annual Weekday Traffic

AASHTO – [American Association of State Highway and Transportation Officials](http://www.transportation.org)
(<http://www.transportation.org>)

ADA – Americans with Disabilities Act

ADDS – Automated Data/Design Standards

ADT – Average Daily Traffic

AHI – Adjusted Hazard Index

AREMA – [American Railway Engineering and Maintenance of Way Association](http://www.arema.org)
(<http://www.arema.org>)

ATR – Automated Traffic Recorder

AWG – American Wire Gauge

AWT – Average Weekday Traffic

C-D – Collector-Distributor

CDR – Collector Distributor Road

CFR – Code of Federal Regulations

CL – Centerline

CORSIM – Corridor Simulation Software

CWP – (GDOT) Construction Work Program

dBA – Decibels, A-Scale

DHV – Design Hour Volume

DMS – Dynamic Message System

DTM – Digital Terrain Model

EN-EN – Entrance followed by entrance (as in ramp terminals)

EN-EX – Entrance followed by exit (as in ramp terminals)

ETI – Engineering Traffic Investigation (Report)

EX-EN – Exit followed by entrance (as in ramp terminals)

EX-EX – Exit followed by exit (as in ramp terminals)

FAA – [Federal Aviation Administration](http://www.faa.gov/) (<http://www.faa.gov/>)

FDR – Freeway Distributor Road

FFPR – (GDOT) Final Field Plan Review

FHWA – [Federal Highway Administration](http://www.fhwa.dot.gov/) (<http://www.fhwa.dot.gov/>)

FRA – [Federal Railroad Administration](http://www.fra.dot.gov/Page/P0001) (<http://www.fra.dot.gov/Page/P0001>)

GDOT – [Georgia Department of Transportation](http://www.dot.ga.gov) (<http://www.dot.ga.gov>)

GLA – Gross Leasable Area

GRIP – [Governor's Road Improvement Program](http://www.dot.ga.gov/BuildSmart/Programs/Pages/GRIP.aspx)
(<http://www.dot.ga.gov/BuildSmart/Programs/Pages/GRIP.aspx>)

GRTA – Georgia Regional Transportation Authority (<http://www.grta.org/>)

HCM – Highway Capacity Manual (see **References** for additional information)

HCS – [Highway Capacity Software](http://mctrans.ce.ufl.edu/hcs/) (<http://mctrans.ce.ufl.edu/hcs/>)

HOV – High Occupancy Vehicle

IES – Illuminating Engineering Society

IESNA – Illuminating Engineering Society of North America (<http://www.iesna.org>)

ISTEA – [Intermodal Surface Transportation Equity Act](http://www.bts.gov/laws_and_regulations/) (http://www.bts.gov/laws_and_regulations/)

ITE – Institute of Transportation Engineers (<http://www.ite.org/>)

L/A – Limited Access

LARP – Local Assistance Road Program

LOS – Level of Service

LR – Long Range

LRFD – (AASHTO) Load and Resistance Factor Design

LRTP – Long Range Transportation Plan

MPO – Metropolitan Planning Organization

MUTCD – Manual on Uniform Traffic Control Devices (FHWA) see **References** for additional information.

NCHRP – [National Cooperative Highway Research Program](http://www.trb.org/NCHRP/NCHRP.aspx)
(<http://www.trb.org/NCHRP/NCHRP.aspx>)

NHS – National Highway System

OCGA – [Official Code of Georgia](http://www.lexis-nexis.com/hottopics/gacode/default.asp) (<http://www.lexis-nexis.com/hottopics/gacode/default.asp>)

OEL – (GDOT) Office of Environment and Location
(<http://www.dot.state.ga.us/preconstruction/oel/index.shtml>)

PDP – (GDOT) Plan Development Process

PE – Preliminary Engineering

PHF – Peak Hour Factor

PHV – Peak Hour Volume

PGL – Profile Grade Line

PI – Point of Intersection (intersection of tangents to a curve)

PC – Point of Curvature (where a curve begins)

PCC – Portland Cement Concrete

PFPR – Preliminary Field Plan Review

PM – Preventive Maintenance

PoDI – Project of Division Interest

PT – Point of Tangent (where a curve ends)

PVI – Point of Vertical Intersection

QPL – (GDOT) Qualified Projects List

RCInfo – Roadway Characteristics Information

RDG – (AASHTO) Roadside Design Guide

ROR – Run-off-Road (as in crash)

ROW – Right-of-Way

RTV – Right Turn Volume

RV – Recreational Vehicle

SIDRA – Signalized and Unsignalized Intersection Design and Research Aid

SPUI – Single Point Urban Interchange

SRTA – State Road and Tollway Authority

STARS – (Georgia) State Traffic and Report Statistics (http://www.dot.state.ga.us/dot/plan-prog/transportation_data/TrafficCD/index.shtml)

STIP – Statewide Transportation Improvement Plan, also referred to as SWTP

SWTP – Statewide Transportation Plan (<http://www.dot.state.ga.us/dot/plan-prog/planning/swtp/index.shtml>)

TAZ – Traffic Analysis Zone

TIP – Transportation Improvement Program

TL – Travel Lane

TOPPS – Transportation Online Policy and Procedure System
(<http://www.dot.state.ga.us/topps/index.shtml>)

TRB – Transportation Research Board

TWLT – Two-Way Left Turn

UAPSM – (GDOT) Utility Accommodation Policy and Standards Manual. See **References** for additional information.

USGS – [United States Geological Survey](http://www.usgs.gov/) (<http://www.usgs.gov/>)

VE – Value Engineering

Vpd – Vehicles per day

WB – Wheel Base (of a design vehicle)

Definition of Terms

3R Project – A non-interstate resurfacing, restoration, or rehabilitation project. For additional information, see **Chapter 11. Other Project Types**

85th Percentile – The speed at or below which 85 percent of the motor vehicles travel (FHWA MUTCD).

AASHTO Green Book – American Association of State Highway and Transportation Officials (AASHTO) publication named *A Policy on Geometric Design of Highways and Streets*. See **References** for additional information.

Access – Entrance to or exit from land adjacent to a public road. (GDOT *Driveway Manual*)

Access Control – see Control of Access

Access Management – Providing (or managing) access to land development while simultaneously preserving the flow of traffic on the surrounding road system in terms of safety, capacity, and speed.

ADA (Americans with Disabilities Act) – A federal law that was enacted in 1990 for the purpose of ensuring that all Americans have the same basic rights of access to services and facilities. The ADA prohibits discrimination on the basis of disability. To effect this prohibition, the statute required certain designated federal agencies to develop implementing regulations.

Adjusted Hazard Index Rating – the summation of the Unadjusted Hazard Index rating, the Adjustment Factor for School Buses, and the Adjustment for Train-Vehicle Crash history. (AHI = A5 + S + A)

Aesthetics – Consideration and/or evaluation of the sensory quality of resources (e.g. sight & sound).

Approach Width: The half of the roadway that is approaching the roundabout. It is also referred to as approach half-width.

Approved Bike or Bicycle Route – See bicycle route, approved

Arterial – Functional classification for a street or highway that provides the highest level of service at the greatest speed for the longest uninterrupted distance, with some degree of access control.

Arterial, Rural– see Rural Arterial

Arterial, Urban – see Urban Arterial

Asymmetrical – Having a different configuration on either side of a centerline

At Grade – A crossing of two highways or a highway and a railroad at the same level.

Attenuator – A device used on roads and highways that acts as a buffer and absorbs the energy of a collision with an automobile.

AutoTURN – An advanced CAD-based software tool developed by TRANSofT Solutions used for analyzing and evaluating vehicle maneuvers for projects such as intersections, roundabouts, bus terminals, loading bays or any on or off-street projects that may involve access, clearance, and maneuverability checks. Additional information about AutoTURN ver 5.1 is available online at: http://www.transoftsolutions.com/transoft/products/at/product_overview.asp (TRANSofT, 2006).

Auxiliary Lane – See Lanes – Auxiliary.

Average Annual Daily Traffic (AADT) - The average 24-hour traffic volume at a given location over a full 365 day year. This means the total of vehicles passing the site in a year divided by 365.

Average Daily Traffic (ADT) – The total volume during a given time period (in whole days), greater than one day and less than a year, divided by the number of days in that time period (GDOT *Driveway Manual*).

Average Annual Weekday Traffic (AAWT) - The average 24-hour traffic volume occurring on weekdays over a full year.

Average Weekday Traffic (AWT) - The average 24-hour traffic volume occurring on weekdays for some period of time less than one year.

Axle Factor – An adjustment factor that may be applied to traffic counts taken with portable traffic counters that account for two axle impacts as one vehicle. The Axle Factor provides for vehicles with more than two axles, such as trucks with three or more axles.

Backwater – “The increase in water surface elevation relative to the elevation occurring under natural channel and floodplain conditions induced upstream from a bridge or other structure that obstructs or constricts a channel (GDOT *Manual on Drainage Design*).”

Base Conditions – An assumed set of geometric and traffic conditions used as a starting point for computations of capacity and level of service (LOS).

Base Year – The year the project is completed and anticipated to be open for traffic use.

Bicycle/Bike Route, Approved - any roadway where there is an existing bikeway or any location where a bicycle facility is identified for such roadway in a state, regional, or local transportation plan.

Bifurcate – An asymmetrical median that typically exceeds a normal median width where both directions of the roadway have independent alignments. The median area may be very wide

and may contain natural vegetation and topography. Recommended for use on rural interstates and freeways.

Big Box Retailer – A large retail establishment (50,000+ sqft.) that is characteristic of a large windowless rectangular single-story building and large parking areas with few community or pedestrian amenities.

Broken Back Curves – See Curves: Broken Back

Capacity – the maximum hourly rate at which persons or vehicles reasonably can be expected to traverse a point or uniform segment of a lane or roadway during a given period under prevailing roadway, traffic, and control conditions.

Centerline – (1) For a two-lane road, the centerline is the middle of the traveled way; and for a divided road, the centerline may be the center of the median. For a divided road with independent roadways, each roadway has its own centerline. (2) The defined and surveyed line shown on the plans from which road construction is controlled.

Center Turn Lane – See Lanes: Center Turn Lane.

Central Business District – the commercial core of a city that can be typified by a concentration of commercial and retail land uses and the greatest concentration and number of pedestrians and traffic.

Central Island – See Island, Central Island

Channelizing Island – See Islands, Channelizing Island

Chevron Alignment Sign – Sign that is typically used on a roadway indicate alignment, a curve, or intersection. Chevron Alignment Signs are characterized by single or multiple reflectorized arrows.

Circulatory Roadway: The roadway around the central island on which circulating vehicles travel in a counterclockwise direction. The width of the circulatory roadway depends mainly on the number of entry lanes and the radius of vehicle paths.

Clear Zone – The area beyond the roadway edge of travel which provides an environment free of fixed objects, with stable, flattened slopes which enhance the opportunity for reducing crash severity. For further clarification on the definition of Clear Zone, refer to the current edition of the *AASHTO Roadside Design Guide*.

Cloverleaf Interchange – See Interchanges, Cloverleaf Interchange.

Collector – Functional classification for a street or highway that provides a less highly developed level of service than an arterial, at a lower speed for shorter distances by collecting traffic from local roads and connecting them with arterials.

Collector, Rural – See Rural Collector.

Collector, Urban - See Urban Collector.

Collector-Distributor (CD) Road – A parallel, controlled-access roadway that separates through traffic from local traffic that is entering and exiting the freeway or interstate system. CD roads are typically used to reduce conflicts associated with weaving.

Consensus – a general agreement among the members of a given group or community.

Construction Standards – A standard drawing published by GDOT and approved by FHWA.

Control of Access – Regulating access (ingress and egress) from properties abutting highway facilities.

Full control of access – Where preference is given to through traffic by providing access connections by means of ramps with only selected public roads and by prohibiting crossings at grade and direct driveway connections.

Partial control of access – Where preference is given to through traffic to a degree. Access connections, which may be at-grade or grade-separated, are provided with selected public roads and private driveways.

CORSIM – A comprehensive microscopic traffic simulation, applicable to surface streets, freeways, and integrated networks with a complete selection of control devices (i.e., stop/yield sign, traffic signals, and ramp metering). It simulates traffic and traffic control systems using commonly accepted vehicle and driver behavior models. (FHWA). Additional information about CORSIM can be found online at: <http://ops.fhwa.dot.gov/trafficanalysis/corsim.htm>

Cross Section – The transverse profile of a road showing horizontal and vertical dimensions.

Cross Slope – The rate of elevation change across a lane or a shoulder.

Crown –

Normal Crown – Roadway cross section which typically occurs when the roadway is a tangent section. No superelevation is present. Roadway cross slopes (typically 2%) in Georgia drain the roadway from either side of the pavement crown. The high point of the road is generally at the centerline or median, and the road slopes down from there.

Reverse Crown – Roadway cross slope that occurs when the normal crown slope (typically 2%) is continuous across a roadway section. This typically occurs as a normal part of a superelevation transition.

Culvert – Any structure under the roadway with a clear opening of 20 feet or less measured along the center of the roadway. Culverts are typically built to carry stormwater.

Curb Cut Ramp – A ramp that provides access between the sidewalk and the street for people who use wheelchairs which leads smoothly down from a sidewalk to a street, rather than abruptly ending with a curb and dropping roughly 4 to 6 inches (www.Wikipedia.org).

Curves –

Broken Back Curves – Successive curves in the same direction separated by a short tangent.

Circular Curve – A curve that has an arc of a constant radius. Note: most horizontal curves on Georgia roadways are circular curves.

Compound Curve – A curve that involves two horizontal curves of different radii sharing a common point for their PT and PC, respectively.

Reverse Curve – A curve consisting of two arcs of the same or different radii curving in opposite directions and having a common tangent or transition curve at their point of junction. The tangent section between the two arcs has 0 length.

Spiral Curve – see Transition Curve

Transition Curve – A curve of variable radius intended to effect a smooth transition from tangent to curve alignment, also known as a Spiral Curve.

Vertical Curve – A curve on the longitudinal profile of a road providing a change of gradient. Vertical curves are parabolic in shape.

dBA – The noise levels in decibels measured with a frequency weighting network, corresponding to the "A-Scale" on a standard sound level meter.

Decision Sight Distance – See Sight Distances: Decision Site Distance.

Department, The – The Georgia Department of Transportation.

Departure Width - The half of the roadway that is departing the roundabout. It is also referred to as departure half-width.

Design Exception – A design condition that does not meet AASHTO guidelines and requires specific approval from the GDOT Chief Engineer and FHWA for Projects of Division Interest.

Design Speed – A selected speed used to determine the various geometric design features of a roadway. The maximum safe speed that can be maintained over a specified section of the road when conditions are so favorable that the design features of the road govern.

Design Variance – A design condition that does not meet GDOT policy. A design variance requires specific approval from the GDOT Chief Engineer.

Design Vehicle – A selected motor vehicle, the weight, dimensions, and operating characteristics of which are used as a control in road design. As defined by FHWA: the longest vehicle permitted by statute of the road authority (state or other) on that roadway (*MUTCD*).

Design Volume – A volume determined for use in design, representing the traffic expected to use the road.

Design Year – The anticipated future life of the project. For all GDOT projects, the design year is 20 years from the base year.

Diamond Interchange – See Interchanges, Diamond Interchange.

Directional Interchange – See Interchanges, Directional Interchange.

Diverging – Dividing a single stream of traffic into separate streams.

Divided Highway – A highway, street or road with opposing directions of travel separated by a median.

Driver Expectancy – What the typical driver would expect to encounter on a roadway.

Easement – Area where GDOT purchases the rights to perform work on a section of property, but does not acquire title to the property.

Embankment – An earthwork structure that raises the roadway higher than surrounding terrain.

Enhancements – Aesthetic additions to a project, such as trees or streetscaping.

Entry Radius: The minimum radius of curvature measured along the right curb at entry of a roundabout. Smaller radii may decrease capacity, while larger radii may cause inadequate entry deflection.

Entry Width: The perpendicular distance from the right curb line of the entry to the intersection of the left edge line and the inscribed circle of a roundabout.

Exit Radius: The minimum radius of curvature measured along the right curb at the exit of a roundabout.

Exit Width: The perpendicular distance from the right curb line of the exit to the intersection of the left edge line and the inscribed circle. Exits should be easily negotiable in order to keep traffic flowing through the roundabout and accelerate out of it. Exit radii should then be larger than entering radii.

Flat Spot – Location in a superelevation transition where the pavement cross slope is 0%

Footcandle – The illumination of a surface with an area of one sqft. on which is uniformly distributed a flux of one lumen. A footcandle is equivalent to one lumen per square foot.

Free Flow – Traffic flow in which the speed of any driver is not impeded.

Free-Flow Speed – The mean speed at which traffic travels when it is at free flow.

Freeway – A controlled access highway system that provides non-interrupted flow of traffic.

Freeway Capacity - The maximum sustained 15-minute flow rate, expressed in passenger cars per hour per lane, that can be accommodated by a uniform freeway segment under prevailing traffic and roadway conditions in one direction of flow.

Frontage Road – “A road that segregates local traffic from higher speed through traffic and intercepts driveways of residences, commercial establishments along the highway (AASHTO *Green Book*, 2011, p. 4-36).”

Functional Classification – The grouping of all streets and highways according to the character of traffic service that they are intended to provide. There are three highway functional classifications: arterial, collector, and local roads.

Geometric Design – The arrangement of the visible elements of a road, such as alignment, grades, sight distances, widths, slopes, etc.

GDOT Policy – A guideline adopted by the Georgia Department of Transportation that must be followed.

Glare Screen – a partition, either continuous or a series of objects of such width and spacing, that is positioned on a median to block the glare from oncoming vehicle headlights.

Gore – The paved area of a roadway between two merging or diverging travel lanes. Travel within the gore area is prohibited.

Grade – (1) The profile of the center of the roadway, or its rate of ascent or descent. (2) To shape or reshape an earth road by means of cutting or filling. (3) Elevation.

Grade Separation – A crossing of two highways or a highway and a railroad at different levels.

Green Book – See AASHTO *Green Book*.

Gutter Width – Distance between the edge of traveled way and the face of curb.

High Occupancy Vehicle – Vehicles with two or more living, not pre-infant, persons.

High Water – The elevation of the highest known specific flooding event at a specific location.

Highway – A general term denoting a public way for purposes of vehicular travel, including the entire area within the right-of-way (NJDOT, 2006).

Highway Section – The part of the highway included between top of slopes in cut and the toe of slopes in fill (NJDOT, 2006).

Horizontal Alignment – Horizontal geometrics of the roadway.

Horizontal Clearance – The lateral distance measured either from the traveled way or the face of curb, to the face of a roadside object or feature. The rural shoulder is the part of the roadway beyond the edge of travel that is graded or paved flush with the edge of travel to allow for emergency usage (AASHTO *Roadside Design Guide*).

Horizontal Curve – A curve by means of which a road can change direction to the right or left.

Human Factors – Driving habits, ability of drivers to make decisions, driver expectance, decision and reaction time, conformance to natural paths of movement, pedestrian use and habits, bicycle traffic use and habits.

Inscribed Circle: The circle formed just inside of the outer curb line of a circulatory roadway.

Interchange – Area where grade separated roadways are connected, and at least one roadway is free flowing.

Cloverleaf Interchange – An interchange that uses loop ramps to accommodate left-turns at an intersection and outer ramps to provide for the right turns.

Diamond Interchange – An interchange that connects a free flowing major road with a minor road. Diamond interchanges typically consist of four one-way diagonal ramps, one in each quadrant and two at-grade intersections on the minor road. The minor road has two stop signs, two signals, or one stop sign and one signal.

Directional Interchange – A free flowing interchange that allows vehicles to travel from one freeway to another freeway at relatively fast and safe speed.

Semi-directional Interchanges – An interchange that provides indirect connection between freeways yet more direct connection than loops.

Service Interchange – An interchange that connects a freeway to a lesser facility (such as a rest area or weigh station), as opposed to another freeway or minor road.

Three Leg Interchange – Also known as T or Y interchanges, this type of interchange is where a major highway begins or ends.

System Interchange – An interchange that connects a freeway to freeway.

Single Point Urban Interchange (SPUI) – An interchange that features a single traffic signal at the center of the interchange which controls all left turns. Opposing left-turn movements are completed simultaneously under the protection of this signal.

Intersection – The general area where two or more highways join or cross, including the roadway and roadside facilities for traffic movements within the area (AASHTO *Green Book*).

Intersection Sight Distance – See Sight Distances: Intersection Sight Distance.

Islands: Devices used to separate or direct traffic in order to facilitate the safe and orderly movement of vehicles. An island may be a raised area that provides a physical barrier to channel traffic movements or a painted area. Specific types of islands include:

Central Island – The roundabout island around which traffic circulates. The central island may either be raised (non-traversable) or flush (traversable). Its size is determined by the width of the circulatory roadway and the diameter of the inscribed circle. The width of any truck apron provided is included in the central island width.

Channelizing Island - “At an intersection, the area defined by curbs, pavement markings, or unpaved areas formed by pavement edges for the purpose of directing traffic into defined paths, providing refuge areas for pedestrians or providing locations for traffic control devices (AASHTO *Green Book*).”

Splitter Island: An island placed within the approach leg of a roundabout to separate entering and exiting traffic, provide a refuge for crossing pedestrians and bicyclists, and prevent wrong way movements. It is usually designed with raised curbing to deflect, and thereby reduce the speed of, entering traffic, and to provide a safer refuge.

L₁₀ – A sound level that is exceeded 10 percent of the time for the period under consideration. This value is an indicator of both the magnitude and frequency of occurrence of the loudest noise events.

Lane Balance – The condition where the number of lanes leaving a diverge is one more than the number of lanes approaching the diverge.

Lanes

Acceleration Lane - A speed-change lane, including tapered areas, for the purpose of enabling a vehicle entering the roadway to increase its speed to a rate at which it can more safely merge with through traffic. Also called an “accel lane” (GDOT *Driveway Manual*).

Auxiliary Lane – The portion of the roadway adjoining the traveled way to help facilitate traffic movements: by providing for parking, speed change, turning, storage for turning, weaving, truck climbing, or for other purposes.

Center Turn Lane – A lane within the median to accommodate left-turning vehicles.

Deceleration Lane – A speed-change lane, including tapered areas, for the purpose of enabling a vehicle that is making an exit turn from a roadway to slow to a safe turning speed after it has left the mainstream of faster-moving traffic. Also called a “decel lane”; it denotes a right turn lane or a left turn lane into a development (GDOT *Driveway Manual*).

Left Turn Lane – A speed-change lane within the median to accommodate left turning vehicles.

Inside Lane - On a multi-lane highway the extreme left hand traffic lane, in the direction of traffic flow, of those lanes available for traffic moving in one direction.

Parking Lane – An auxiliary lane primarily for the parking of vehicles.

Passing Lane –

(1) A section of two-lane, two-directional road where sufficient clear sight distance exists to allow a safe passing maneuver to be performed.

(2) An additional (third) lane that has been added to a two-lane roadway specifically for passing.

Turn Lane – A traffic lane within the normal surfaced width of a roadway, or an auxiliary lane adjacent to or within a median, reserved for vehicles turning left or right at an intersection.

Traffic Lane – The portion of the traveled way for the movement of a single line of vehicles in one direction.

Letting – The date GDOT opens sealed bids from prospective contractors.

Level of Service – A qualitative rating of a road's effectiveness relative to the service it renders to its users (from A-best to F-worst). LOS is measured in terms of a number of factors, such as operating speed, travel time, traffic interruptions, freedom to maneuver and pass, driving safety, comfort, and convenience.

Lighting

High Mast Roadway Lighting– Illumination of a large area by means of a group of luminaires designed to be mounted in fixed orientation at the top of a high mast, generally 80 feet or higher (AASHTO *Roadway Lighting Design Guide*, 2005).

Pedestrian Lighting – Illumination of public sidewalks for pedestrian traffic generally not within rights-of-way for vehicular traffic roadways. Included are skywalks (pedestrian overpasses), sub-walks (pedestrian tunnels), walkways giving access to park or block interiors and crossings near centers of long blocks (AASHTO *Roadway Lighting Design Guide*, 2005).

Roadway Lighting - Illumination of roadways by means of fixed luminaires in order to reduce driver conflict with other vehicles and pedestrians.

Limited Access Facility – A street or highway to which owner or occupants abutting land have little or no right of access.

Local Road – Functional classification that consists of all roads not defined as arterials or collectors; primarily provides access to land with little or no through movement.

Longitudinal Barrier – A barrier that is intended to safely redirect an errant vehicle away from a roadside or median hazard (CODOT, 2006)

Loop Detector – A traffic monitoring tool that is used to detect the presence of vehicles at an intersection to activate a traffic signal.

Median – The portion of a divided roadway separating the traveled ways for traffic in opposite directions (NJDOT, 2006).

Median Crossover – An opening constructed in the median strip of a divided highway designed to allow traffic movements to cross from one side of the highway to the other. In some cases, the Access Management Engineer may require the design to be such that some movements be physically prohibited (*GDOT Driveway Manual*).

Median Width – The overall width of a median measured from edge of travel lane to edge of travel lane.

Merging – The converging of separate streams of traffic to a single stream.

Mitigation – sequentially avoiding impacts, minimizing impacts, and compensating for any unavoidable impacts (WSDOT, 2005).

Mitigation Plan – document(s) that contain all information and specifications necessary to fully implement and construct a compensatory mitigation project (WSDOT, 2005).

Nominal Safety – A design alternative's adherence to design criteria and standards.

Normal Crown – See Crown: Normal Crown

Operating Speed – Actual speed at which traffic flows.

Pace Speed – The highest speed within a range of speeds (typically within 10 mph) that represents more vehicles than in any other like range of speed (FHWA *MUTCD*)

Parametrics – A modeling platform with application areas that include urban, highway, public transport, congested, free flow, ITS and HOV. Additional information about Parametrics is available online at: <http://www.parametrics.com>

Parking Lane – See Lanes: Parking Lane

Passenger Car – A passenger automobile with similar size and operating characteristics of a car, sport/utility vehicle, minivan, or pick-up truck.

Passing Lane – See Lanes: Passing Lane.

Passing Sight Distance – See Sight Distances: Passing Sight Distance.

Pavement Markings – Devices or paint placed on the roadway to mark pavement for vehicular and pedestrian traffic control.

Pedestrian – Georgia State law defines a Pedestrian as: “Any person who is afoot” (GLC 40-1-1). By state definition, roller skaters, in-line skaters, skateboarders, and wheelchair users are also considered pedestrians.

Pedestrian Refuge – Also referred to as a refuge island/area or pedestrian island, is a section of pavement or sidewalk where pedestrians can stop before finishing crossing a road (www.wikipedia.org).

Permit – A legal document issued by the Department authorizing an applicant to do specific work on state rights-of-way (GDOT *Driveway Manual*).

Posted Speed – The speed limit posted on a section of roadway.

Preventative Maintenance (PM) Projects – the planned strategy of cost effective treatments to an existing roadway system and its appurtenances that preserves the system, retards future deterioration, and maintains or improves the functional condition of the system without increasing structural capacity.

Profile – A longitudinal section of a roadway, drainage course, etc.

Profile Grade Line – The point for control of the vertical alignment. Also, normally the point of rotation for superelevated sections (NJDOT, 2006).

Project – "A portion of a highway that a State proposes to construct, reconstruct, or improves as described in the Preliminary Design Report or applicable Environmental Document (FHWA VE Website, 2005)."

Queue – When one or more vehicles is traveling less than 7 mph. (SimTraffic, 2006) A vehicle is considered queued when it is either stopped at a traffic light or stop sign or behind another queued vehicle.

Ramp Metering – Use of a traffic control device for the intent of regulating the flow of traffic entering a freeway. The device, which is typically a traffic signal or a two-phase (red and green, no yellow) light, prevents multiple vehicles entering a freeway ramp.

Reaction Time – “The time from the onset of a stimulus to the beginning of a driver's (or pedestrian's) response to the stimulus, by a simple movement of a limb or other body part. (FHWA, 2001 <http://www.tfhr.gov/safety/pubs/97135/glossary.htm#r>).“

Retaining Wall – A structure that prevents dirt from sliding or eroding.

Reverse Crown – See Crown: Reverse Crown

Reverse Curve – See Curves: Reverse Curve

Right-of-way (ROW or R/W) - All land under the jurisdiction of, and whose use is controlled by the Department (GDOT *Driveway Manual*).

Right-of-Way Flares – Areas needed for sight distance triangles at an intersection that should be kept free of obstructions in order to provide adequate sight distance.

Roadside – The area adjoining the outer edge of the roadway (NJDOT, 2006).

Roadway – The portion of a highway, including shoulders, for vehicle use (NJDOT, 2006).

Roadway Characteristics – The geometric characteristics of the freeway segment under study, including the number and width of lanes, right-shoulder lateral clearance, interchange spacing, vertical alignment, and lane configurations.

Running Speed – For all traffic, or a component thereof, the summation of distances traveled divided by the summation of running time.

Rural Area – “Those areas outside the boundaries of urban areas (AASHTO *Green Book*).”

Rural Arterial – Functional classification for a street or highway that integrates interstate and inter-county service, provides for movements between urban areas, and provides for relatively high travel speeds with minimum interference to through movement (AASHTO *Green Book*).

Rural Collector - A street or highway that “generally serves travel of primarily intra-county rather than statewide importance and constitute those routes on which (regardless of traffic volume) predominant travel distances are shorter than on arterial routes. Consequently, more moderate speeds may be typical, on the average (AASHTO *Green Book*).”

Rural Section – Any roadway without curb and gutter.

Rural Shoulder – The part of the roadway beyond the edge of travel that is graded or paved flush with the edge of travel to allow for emergency usage.

Semi-Directional Interchange – See Interchanges, Semi-Directional Interchange

Service Interchange – See Interchanges, Service Interchange.

Shoulder – The portion of the roadway contiguous with the traveled way for accommodation of stopped vehicles, for emergency use, and for lateral support of base and surface courses (NJDOT, 2006).

Shoulder Rumble Strip – “A longitudinal design feature installed on a paved roadway shoulder near the travel lane. It is made of a series of indented or raised elements intended to alert inattentive drivers through vibration and sound that their vehicles have left the travel lane. On divided highways, they are typically installed on the median side of the roadway as well as on the outside (right) shoulder (FHWA, 2001, Roadway Shoulder Rumble Strips Technical Advisory Website <http://www.fhwa.dot.gov/legsregs/directives/techadvs/t504035.htm>).”

Sidewalk – The portion of a street between the curb lines, or the lateral lines of a railway, and the adjacent property lines, intended for use by pedestrians (Georgia Code and Rules 40-1-1).

Sight Distances – The length of roadway ahead visible to a driver.

Decision Sight Distance – Sight distance that allows a driver to determine and complete the most efficient maneuver in response to an unexpected condition

Intersection Sight Distance – Sight distance needed for decisions at complex locations such as intersections. Values are substantially greater than Stopping Sight Distance.

Passing Sight Distance – Sight distance needed for passing other vehicles (applicable only on two-way, two-lane highways at locations where passing lanes are not present).

Stopping Sight Distance - Sight distance needed for a driver to see an unexpected condition and stop the vehicle. At a minimum, Stopping Sight Distance is required at all locations on all roadways.

Sight Distance Triangle – Specified areas along intersection approach legs and across their included corners that should remain clear of obstructions. (AASHTO *Green Book*)

Slope – The face of an embankment or cut section; any ground the surface of which makes an angle with the plane of the horizon.

Speed Design – See Design Speed

Speed Zone – a section of highway with a speed limit that is established by law but which might be different from a legislatively specified statutory speed limit (FHWA *MUTCD*).

Spiral – See Curves: Transition Curve

Standard – Criteria having recognized and usually permanent values which are established formally as a model or requirement.

Stopping Sight Distance – See Sight Distances: Stopping Sight Distance.

Superelevation – The elevating of the outside edge of a curve to partially offset the centrifugal force generated when a vehicle rounds the curve.

Superelevation Runoff – “The length of roadway needed to accomplish a change in outside-lane cross slope from zero (flat) to full superelevation, or vice versa (AASHTO *Green Book*, 2011, p. 3-59).”

Superelevation (Tangent) Runout – The longitudinal distance required to transition between normal crown and 0% cross slope (or vice versa).

Superelevation Transition – “The superelevation runoff and tangent runout sections (AASHTO *Green Book*, 2011, p. 3-59).”

Sustained Grade – A continuous road grade of appreciable length and consistent, or nearly consistent, gradient.

Synchro – software application used for traffic analysis, specifically to optimize traffic signal timing and perform capacity analyses. The software supports the Universal Traffic Data Format (UTDF) for exchanging data with signal controller systems and other software packages.

System Interchange – See Interchanges, System Interchange

T Interchange - See Interchanges, Three-Leg Interchange

Traffic Characteristics – any characteristic of the traffic stream that may affect capacity, free-flow speed, or operations, including the percentage composition of the traffic stream by vehicle type and the familiarity of drivers with the freeway.

Traffic Control Device – A sign, signal, marking or other device placed on or adjacent to a street or highway by authority of a public body or official having jurisdiction to regulate, warn, or guide traffic.

Traffic Lane – See Lanes: Traffic Lane.

Transfer Road – A road that connects core roadways and C-D roads

Transition – A section of variable pavement width required when changing from one width of traveled way to a greater or lesser width.

Transition Curve – See Curves: Transition Curve

Traveled Way – The portion of the roadway provided for the movement of vehicles, exclusive of shoulders, auxiliary lanes and bicycle lanes (NJDOT, 2006).

Truck Apron – The mountable portion of a roundabout central island that is drivable specifically provided to accommodate the path of the rear left wheels of larger vehicles.

Turn Lane – See Lanes: Turn Lane.

Turning Path – The path of a designated point on a vehicle making a specified turn.

Urban Area – “Places within boundaries set by the responsible State and local officials having a population of 5,000 or more (AASHTO *Green Book*).”

Urban Arterial – Functional classification for a street or highway that serves urbanized areas and provides the highest level of service at the greatest speed for the longest uninterrupted distance, with some degree of access control.

Urban Collector – A street or highway that provides both land access service and traffic circulation within residential neighborhoods, commercial or industrial areas. It differs from the arterial system in that facilities on a collector system may penetrate residential neighborhoods,

distributing trips from the arterials through the area to the ultimate destination. Conversely, the collector street also collects traffic from local streets in residential neighborhoods and channels it into the arterial system (AASHTO *Green Book*).

Urban Roadway – A roadway that is classified functionally as an Urban Arterial, Urban Collector, or Urban Local Street that operates at speeds generally less than or equal to 45 mph and features curb and gutter.

Urban Shoulder – The part of an urban roadway beginning at the edge of travel and extending to the breakpoint of the fore slope or back slope that ties to the natural terrain.

Value Engineering – "The systematic application of recognized techniques by a multi-disciplined team to identify the function of a product or service, establish a worth for that function, generate alternatives through the use of creative thinking, and provide the needed functions to accomplish the original purpose of the project, reliably, and at the lowest life-cycle cost without sacrificing safety, necessary quality, and environmental attributes of the project. (CFR Title 23 Part 627). "

Variance – See Design Variance.

Vertical Alignment (Profile Grade) – The trace of a vertical plane intersecting the top surface of the proposed wearing surface, usually along the longitudinal centerline of the roadbed, being either elevation or gradient of such trace according to the context.

Vertical Curve – See Curves: Vertical Curve.

Weaving – The crossing of two or more traffic streams traveling in the same general direction along a significant length of highway without the aid of traffic control devices (with the exception of guide signs). Weaving segments are formed when a merge area is closely followed by a diverge area, or when an on-ramp is closely followed by an off-ramp and the two are joined by an auxiliary lane. (TRB *Highway Capacity Manual*)

Work Zone – An area of a highway with construction, maintenance, or utility work activities. A work zone is typically marked by signs, channelizing devices, barriers, pavement markings, and/or work vehicles. It extends from the first warning sign or high-intensity rotating, flashing, oscillating, or strobe lights on a vehicle to the END ROAD WORK sign or the last TTC device (FHWA *MUTCD*, 2009).

Yield Line: A broken line marked across the entry roadway where it meets the outer edge of the circulatory roadway and where entering vehicles wait, if necessary, for an acceptable gap to enter the circulating flow.

Y Interchange - See Interchanges, Three-Leg Interchange.

Chapter 1. Introduction - Contents

Chapter 1. Introduction - Contents	1-i
1.1 Purpose	1-1
1.2 Organization	1-1
1.3 Contact	1-1
1.4 Manual Updates.....	1-2
1.5 Project Review and Submission Requirements.....	1-2
1.6 Acknowledgements.....	1-2

Chapter 1. Introduction

1.1 Purpose

The GDOT Design Policy Manual is the primary resource for design guidelines and standards adopted by the Georgia Department of Transportation (GDOT) for the design of roadways and related infrastructure. This manual is intended to provide the designer with both recommended and required design criteria. Designers are encouraged to select design criteria that provide a balance between the design vehicles, other users of the facility, and the context of the surrounding environment.

The criteria presented in this manual is based on policies and principals defined by the Georgia Department of Transportation, the Federal Highway Administration, the American Association of State Highway and Transportation Officials (AASHTO), and various national research organizations.

This manual was written primarily for use by GDOT personnel, local governments, and consulting engineering firms that prepare roadway construction plans for Federal-Aid projects and State-Aid projects in accordance with the policies and objectives of Titles 23, 40, and 42 of the United States Code, and Title 32 of the Official Code of Georgia Annotated.

1.2. Organization

The Georgia Department of Transportation improves, constructs, and maintains the state's roads and bridges and provides planning and financial support for other modes of transportation such as mass transit and airports. GDOT also provides administrative support to the State Road and Tollway Authority (SRTA) and the Georgia Regional Transportation Authority (GRTA). GDOT's mission statement is:

The Georgia Department of Transportation provides a safe, seamless and sustainable transportation system that supports Georgia's economy and is sensitive to its citizens and environment.

GDOT is managed and operated by the Commissioner of the Georgia Department of Transportation with direct oversight by the State Transportation Board. The GDOT Organizational Chart can be found at: <http://www.dot.ga.gov/AboutGeorgia/Documents/OrgChart.pdf>

The mission of the GDOT Division of Engineering is to develop quality sets of right-of-way and construction plans, and bid documents that provide the best transportation value for the taxpayers of Georgia. This is accomplished in a cooperative effort which includes project managers and other GDOT offices.

1.3. Contact

The GDOT Design Policy Manual is maintained by the Division of Engineering, Office of Design Policy & Support. To submit questions or comments specific to the GDOT Design Policy Manual please send an email to the contact listed here: [Design Policy Manual Homepage](#).

1.4. Manual Updates

The GDOT Design Policy Manual is updated periodically to reflect the Department's current design policies and practices. An entire chapter may be added or any portion of an existing chapter revised at any time. The version and latest revision date are listed in the manual's Table of Contents, in the Table of Contents for each chapter, and at the bottom of each page of the manual. Implementation dates may be specified for certain revisions.

Subscribers to the Department's *Repository for Online Access to Documentation and Standards* (R.O.A.D.S.) homepage, Design Policies and Guidelines, will receive e-mail notices of updates.

1.5. Project Review and Submission Requirements

Project review and submission requirements shall be in accordance with the latest edition of the GDOT *Plan Development Process* (PDP). The current PDP is published online at: <http://www.dot.ga.gov/PS/DesignManuals>

The GDOT PDP sets forth the current procedures and steps necessary for GDOT to administer Federal-Aid projects in accordance with the policies and objectives of Titles 23, 40, and 42 United States Code, and to administer State-Aid projects to fulfill the policies and objectives of Title 32, Official Code of Georgia Annotated. The GDOT PDP outlines the current process of project development from project identification through construction award.

All design criteria and design decisions should be documented in a Project Design Data Book kept with the project files. The requirements for maintaining a complete and up-to-date Project Design Data Book are presented in the GDOT PDP Chapter 5, Concept Design.

1.6. Acknowledgements

The GDOT Design Policy Manual was developed by a team of individuals from GDOT, FHWA, and the Georgia engineering consultant community. The GDOT Division of Engineering acknowledges the following individuals for their contributions toward the development of this manual:

GDOT - Brent Story, Eugene Hopkins, Brad Ehrman, Kim Fulbright, Jim Simpson, Daniel Pass, Ben Buchan, Darrell Richardson, Darryl Van Meter, Chuck Hasty, Babs Abubakari, Keith Golden, Kathy Zahul, Abby Ebodaghe, Gary Langford, Joel North, Joe Wheeler, Ron Wishon, Del Clippard

FHWA - David Painter and the Georgia Division of FHWA

Consultants - Stan Hicks, Bill Pate, Jody Braswell, Jill Hodges, Joe Macrina, Tim Heilmeier, Taylor Stukes, Julie Doyle, Jeff Dyer, Michael Holt, Mike Reynolds, Harris Robinson, Vern Wilburn, Tommy Crochet

Chapter 2. Design Policy Guidelines and Standards - Contents

- Chapter 2. Design Policy Guidelines and Standards 2-i
 - 2.1 General Design Policy Information2-1
 - 2.1.1. Definitions.....2-1
 - 2.1.2. Sources of Design Policy and Practice2-3
 - 2.2 Exception to Design Standards2-4
 - 2.2.1. Design Exception2-4
 - 2.2.2. Design Variance2-4
 - 2.2.3 Design Variances for Off-System Roadway2-5
 - 2.3 Context Sensitive Design2-7

Chapter 2. Design Policy Guidelines and Standards

2.1 General Design Policy Information

Design policy is defined as the basic principles and goals established by GDOT to guide and control the design of roadways and related infrastructure in Georgia. Flexibility is permitted to encourage independent design tailored to individual situations. When flexibility is applied to a proposed design, and critical dimensions do not meet GDOT design policy, additional documentation is required to document the decision-making-process.

Criteria within this manual denoted as “standard” have been identified as a required or mandatory practice with deviation from the controls requiring prior agency approval. All other criteria within this manual are considered to be “guidelines” intended as recommended practice with deviation allowed if engineering judgment or study indicate the deviation to be appropriate. Designers are encouraged to select design criteria that provide a balance between the design vehicles, other users of the facility, and the context of the surrounding environment.

Unless stated otherwise, the policies in this manual apply to permanent construction of roadways and related infrastructure. Different criteria may be applicable to temporary facilities. Guidance specific to preventative maintenance (PM) and non-interstate roadway resurfacing, restoration, or rehabilitation (3R) projects is provided in Chapter 11 of this Manual.

2.1.1. Definitions

The following definitions offer guidance for interpreting policy statements found in this manual:

- **Standard:** A required criteria or mandatory practice. Criteria denoted as standard have been identified by the Department as having substantial importance to the operational and safety performance of a roadway such that special agency review and approval (Design Exception or Design Variance) will be required before deviation from the controls can be retained or incorporated into a design. All “10 Controlling Criteria” are denoted as standard. When using this Manual, all standard statements are labeled and the text appears in bold type. The verb “shall” is typically used.
- **Guideline:** Recommended practice in typical situations. Deviations from criteria denoted as guidelines are allowed when engineering study indicates the deviation to be appropriate. Adequate study, justification, and documentation by the GDOT office or consultant responsible for the engineering are required. Decisions to deviate from guidelines are subject to review and scrutiny by GDOT at any time. The verb “should” is typically used.
- **Controlling Criteria on the National Highway System (NHS):** The FHWA has specifically identified the 10 design elements listed below as having substantial importance to the operational and safety performance of a roadway such that special agency attention should be given to the criteria in the design decision making process. Of the 10 controlling criteria, only design loading structural capacity and design speed apply to all NHS facility types. The remaining eight criteria are applicable only to “high-speed” NHS roadways, defined as Interstate highways, other freeways, and roadways with a design speed greater than or equal to 50 mph.

All NHS Roadways:

- (1) **Design Speed** – See Section 3.3, *Design Speed*.
- (2) **Design Loading Structural Capacity** – See [GDOT Bridge & Structural Manual](#).

Interstate Highways, Other Freeways, and Roadways with Design Speed ≥ 50 mph (NHS):

- (3) **Stopping Sight Distance** – See Section 4.1.2, *Stopping Sight Distance*.
- (4) **Horizontal Curve Radius** – See Section 4.2, *Horizontal Alignment*
- (5) **Maximum Grade** – See Section 4.3, *Vertical Alignments*.
- (6) **Vertical Clearance** – See [GDOT Bridge & Structural Manual](#).
- (7) **Superelevation Rate** – See Section 4.5.1, *Maximum Superelevation Rates*.
- (8) **Lane Width** – See Section 6.1, *Lane Width*.
- (9) **Cross Slope** – See Section 6.3, *Cross Slope*.
- (10) **Shoulder Width** – See Section 6.5, *Shoulders*.

The criteria defined by AASHTO for each of the “10 Controlling Criteria” are adopted and denoted as standard by GDOT. Minimum values are either given or implied by the lower value in a given range of values. A decision to use a design value that does not meet the minimum criteria defined by AASHTO will require the prior approval of a Design Exception as defined in Section 2.2.1 of this chapter. **If the AASHTO minimum criteria aren’t met for criterion 3-10 listed above on roadways with a design speeds less than 50 mph, then prior approval of a Design Variance as defined in Section 2.2.2 of this chapter will be required.**

- **GDOT Standard Design Criteria:** GDOT has specifically identified the additional design elements listed below as having substantial importance to the operational and safety performance of a roadway such that special agency attention should be given to the criteria in the design decision making process.
 - (1) **Access Control** – See Section 3.5, *Establishment of Access Control* and Section 7.3 *Median Openings*.
 - (2) **Intersection Sight Distance** - See Section 4.1.5, *Intersection Sight Distance*.
 - (3) **Intersection Skew Angle** – See Section 4.1.6, *Intersection Skew Angle*.
 - (4) **Tangent Lengths on Reverse Curves Design Speed ≥ 50** – See Section 4.2.2, *Types of Curves*
 - (5) **Lateral Offset to Obstruction** – See Chapter 5, *Roadside Safety and Lateral Offset to Obstruction*.
 - (6) **Shoulder Width** – See Section 6.5, *Shoulders*
 - (7) **Rumble Strips** – See Section 6.5.1, *Rumble Strips*.
 - (8) **Safety Edge** – See Section 6.5.2, *Pavement Edge Treatment*.
 - (9) **Median Usage** – See Section 6.12, *Medians*.

- (10) **Roundabout Illumination Levels** – See Section 8.2.4, *Lighting*.
- (11) **Pedestrian, Bicycle and Transit Warrants (i.e., Complete Streets Warrants)** – See Section 9.4 *Warrants for Accommodation*.
- (12) **ADA Requirements in PROWAG** – See Section 9.5.1 *Pedestrian Accommodation Design*
- (13) [GDOT Construction Standards](#) – See ROADS web site.
- (14) [GDOT Drainage Manual](#) – See ROADS web site.

The criteria defined by GDOT for each of these design elements are denoted as standard. Minimum values are either given or implied by the lower value in a range of values. A decision to use a design value that does not meet the minimum criteria defined by GDOT in this manual will require the prior approval of a Design Variance as defined in Section 2.2.2 of this chapter. If a design exception is approved a separate design variance is not required.

- **Shall:** The use of the word “shall” denotes a required or mandatory condition, and the designer must make every effort to follow the appropriate design criteria or condition.
- **Should:** The use of the word “should” indicates an advisory condition. Under this condition, it is recommended, although not mandatory, that the designer follow the appropriate design criteria.
- **May:** The use of the word “may” indicates a permissive condition. Under this condition, the designer is encouraged to use sound engineering judgment.
- **Where practical:** Practical is defined as effective and applicable; appropriate, adaptable, and balanced. The use of the term “where practical” is intended to indicate that the designer may consider economic resource constraints when making a design decision.

2.1.2. Sources of Design Policy and Practice

GDOT adopts the [AASHTO Green Book, “A Policy on Geometric Design of Highways and Streets,”](#) and the [AASHTO “A Policy on Design Standards - Interstate System”](#) as the fundamental guideline and standard for design criteria required on State Routes and routes on the National Highway System (NHS) in Georgia.

For additional guidance on the design of roadways and related infrastructure, refer to the most current edition of the publications cited in the References section of this Manual, unless a specific version is noted. The References section includes the website addresses (url) for resources available online. The following is a list of sources for those publications.

- *American Association of State Highway and Transportation Officials (AASHTO)*
- *American Railway Engineering and Maintenance of Way Association (AREMA)*
- *Federal Highway Administration (FHWA)*
- *Georgia Department of Transportation (GDOT)*
- *Georgia Soil and Water Conservation Commission (GSWCC)*
- *Illuminating Engineering Society of North America (IESNA)*

- *Institute of Transportation Engineers (ITE)*
- *National Association of City Transportation Officials (NACTO)*
- *National Cooperative Highway Research Program (NCHRP)*
- *National Fire Protection Association (NFPA)*
- *Texas Transportation Institute (TTI)*
- *Transportation Research Board (TRB)*
- *United States Access Board (Access Board)*

2.2 Exception to Design Standards

2.2.1. Design Exception

If a design feature of a new construction or reconstruction project does not meet the minimum value of one of the “10 Controlling Criteria” on high speed NHS roadways defined in the current edition of the [AASHTO Green Book](#) or the AASHTO publication, [A Policy on Design Standards - Interstate System](#), then approval to build or retain the feature is required by formal Design Exception. For projects identified as “Project of Division Interest” or all interstate projects, the FHWA is the agency that grants Design Exceptions. A Design Exception is also required for connecting roadways to NHS high speed facilities (i.e. ramps, collector-distributors, etc.) regardless of the design speed. For all other projects, both federally and state funded, the GDOT Chief Engineer grants Design Exceptions.

The requirement of a Design Exception is not meant to impede design flexibility, but to document a very important design decision that is well scrutinized by the Department in a deliberative and thorough manner. To obtain a Design Exception, a comprehensive study and formal request shall be submitted using the format and procedures outlined in the GDOT Plan Development Process (PDP), and in the FHWA publication, [Mitigation Strategies for Design Exceptions](#). See Table 2.1 for clarification on exception to design standards.

2.2.2. Design Variance

Whenever a criteria other than a “10 Controlling Criteria on high speed NHS” has been denoted by GDOT as a standard, then the approval of a Design Variance must be obtained by the GDOT Chief Engineer before deviation outside the minimum controls can be incorporated into the design. See Table 2.1 for clarification on exception to design standards.

The requirement of a Design Variance is not meant to impede design flexibility, but to document a very important design decision that is well scrutinized by the Department in a deliberative and thorough manner. To obtain a Design Variance, a comprehensive study and formal request shall be submitted using the format and procedures outlined in the [GDOT Plan Development Process manual](#) (PDP).

All design exceptions and design variances should be submitted to the following email address: DesignException@dot.ga.gov

2.2.3 Design Variances for Off-System Roadway

For off-system roadways a formal Design Exception or Design Variance as defined in Chapter 2.2.1 and 2.2.2 will not be required regardless of whether state or federal funding is involved, with the two exceptions listed below:

1. Whenever employees of the Department are directly involved in the engineering and design, right-of-way acquisition, and/or construction letting of a project on an off-system roadway, then the normal approval of a Design Variance by the Department's Chief Engineer will be required before any deviation to minimum design standards can be incorporated into the project. This also applies to any of the above work activity being accomplished on behalf of the Department by consulting engineering firms or contractors hired by the Department.
2. Any deviation proposed to "Design Loading Structural Capacity"¹ standards will require the normal approval of a Design Variance from the Department's State Bridge Engineer and/or the Department's Chief Engineer before any deviation can be incorporated into a project.

The waiver of a formal Design Variance for off-system roadways does not affect project framework agreements between the Department and Local Governments, including the expectation to observe the design policies defined in the GDOT Design Policy Manual.² The Department encourages local governments and their Engineer-of-Record to document all design decisions to demonstrate compliance with accepted engineering principles and the reasons for the decision.

¹ Criteria for Design Loading Structural Capacity is published in the GDOT [Bridge and Structures Design Manual](http://www.dot.ga.gov/PartnerSmart/DesignManuals/BridgeandStructure/GDOT_Bridge_and_Structures_Policy_Manual.pdf) at internet address: http://www.dot.ga.gov/PartnerSmart/DesignManuals/BridgeandStructure/GDOT_Bridge_and_Structures_Policy_Manual.pdf

² **Title 23 U.S.C. 109(o), Compliance With State Laws for Non-NHS Projects**

Projects (other than highway projects on the National Highway System) shall be design, constructed, operated, and maintained in accordance with State laws, regulations, directives, safety standards, and construction standards.

Table 2.1 Exception to Design Standards

	< 50 mph (low speed)				≥ 50 mph (high speed)			
	* NHS	State Route	** Off-System	Off-System	*NHS	State Route	** Off-System	Off-System
FHWA Controlling Criteria								
Design Speed	DE	DV	DV	N/A	DE	DV	DV	N/A
Design Loading Structural Capacity	DE	DV	DV	DV	DE	DV	DV	DV
Stopping Sight Distance	DV	DV	DV	N/A	DE	DV	DV	N/A
Horizontal Curve Radius	DV	DV	DV	N/A	DE	DV	DV	N/A
Maximum Grade	DV	DV	DV	N/A	DE	DV	DV	N/A
Vertical Clearance	DV	DV	DV	N/A	DE	DV	DV	N/A
Superelevation Rate	DV	DV	DV	N/A	DE	DV	DV	N/A
Lane Width	DV	DV	DV	N/A	DE	DV	DV	N/A
Cross Slope	DV	DV	DV	N/A	DE	DV	DV	N/A
Shoulder Width	DV	DV	DV	N/A	DE	DV	DV	N/A
GDOT Standard Criteria								
Access Control	DV	DV	DV	N/A	DV	DV	DV	N/A
Shoulder Width	N/A	N/A	N/A	N/A	DV	DV	DV	N/A
Intersection Sight Distance	DV	DV	DV	N/A	DV	DV	DV	N/A
Intersection Skew Angle	DV	DV	DV	N/A	DV	DV	DV	N/A
Tangent Lengths on Reverse Curves	N/A	N/A	N/A	N/A	DV	DV	DV	N/A
Lateral Offset to Obstruction	DV	DV	DV	N/A	DV	DV	DV	N/A
Rumble Strips	DV	DV	DV	N/A	DV	DV	DV	N/A
Safety Edge	DV	DV	DV	N/A	DV	DV	DV	N/A
Median Usage	DV	DV	DV	N/A	DV	DV	DV	N/A
Roundabout Illumination Levels	DV	DV	DV	N/A	DV	DV	DV	N/A
Pedestrian, Bicycle, and Transit Warrants	DV	DV	DV	N/A	DV	DV	DV	N/A
ADA requirement in PROWAG	DV	DV	DV	N/A	DV	DV	DV	N/A
GDOT Construction Standards	DV	DV	DV	N/A	DV	DV	DV	N/A
GDOT Drainage Manual	DV	DV	DV	N/A	DV	DV	DV	N/A
<p>* A Design Exception is also required for connecting roadways to NHS high speed facilities (i.e. ramps, collector-distributors, etc.) regardless of the design speed.</p> <p>**When GDOT personnel resources are involved in design, engineering, ROW acquisition, or construction letting</p> <p>DE- Design Exception, FHWA Requirement</p> <p>DV- Design Variance, GDOT Requirement</p>								

2.3 Context Sensitive Design

Context Sensitive Design (CSD) is a process for achieving design excellence by developing transportation solutions that require continuous, collaborative communication and consensus among transportation agencies, professionals, and stakeholders. A common goal of CSD projects is to develop a facility that is harmonious with the community, and preserves aesthetics, history and the environmental resources, while integrating these innovative approaches with traditional transportation goals for safety and performance.

Refer to the [GDOT Context Sensitive Design Manual](#) for additional information on communication strategies, design flexibility, environmental sensitivity, and stakeholder involvement for developing successful context-sensitive solutions.

Intentionally Left Blank

Chapter 3. Design Controls - Contents

Chapter 3. Design Controls - Contents	3-i
3.1. Functional Classification	3-1
3.2 Design Vehicles	3-5
3.2.1. Design Vehicle Types.....	3-6
3.2.2. Local Input for Selecting a Design Vehicle	3-7
3.2.3. Special Roadways and Networks.....	3-8
3.2.4 Design Vehicle Turning Paths	3-9
3.2.5 Design Vehicles and Pedestrians.....	3-9
3.2.6. Accommodation of OSOWs	3-9
3.3. Design Speed	3-10
3.3.1. General Considerations.....	3-10
3.3.2. Intersections Approaching a Stopped Condition	3-10
3.3.3. Freeway Exit and Entrance Ramps.....	3-10
3.3.4. Urban Subdivision Streets.....	3-11
3.4. Highway Capacity.....	3-11
3.5. Establishment of Access Control	3-11
3.5.1. Definitions.....	3-11
3.5.2. Access Management.....	3-12
3.5.3. Right of Way (R/W) and Limit of Access (L/A) Line Descriptions	3-15
3.6. Frontage Roads and Access Roads	3-16
3.7. Fencing.....	3-17
3.7.1 Fencing on State Right-of-Way	3-17
3.7.2 Fencing on Private Property	3-19
3.8. Right-of-Way Controls	3-19
3.8.1. Rural Areas	3-20
3.8.2. Urban Areas	3-20
3.8.3. Special Types of Right-of-Way.....	3-20
3.8.4. Accommodating Utilities	3-21
3.9. Value Engineering	3-22
3.10. Environmental	3-22

Chapter 3. Design Controls

This chapter provides information with regard to design controls. Many factors contribute to the roadway design criteria used by designers. These factors are based upon the physical characteristics of the vehicles (vehicle types), the topography in which the road is set, operational safety and speed of traffic on the road, and even driver behavior (speed, turns, following distance, clear zones for emergencies). All of these factors are important and should be balanced when selecting the appropriate design criteria for a particular road or highway design. This chapter addresses:

- functional classification;
- design vehicles;
- design speed;
- highway capacity;
- access control;
- frontage and access roads;
- fencing;
- right-of-way controls;
- value engineering; and
- environmental considerations.

3.1. Functional Classification

Design standards have been developed by the [American Association of State Highway and Transportation Officials \(AASHTO\)](#) for different functional systems of roadways. In order to qualify for federal funding, the [Federal Highway Administration \(FHWA\)](#) requires that each state categorize state routes by functional classification. Detailed discussions on the concept of functional classification and the characteristics of the various functional systems can be found in the AASHTO *Green Book*¹ and FHWA *Functional Classification Guidelines*².

Roadway functional classification serves as the foundation of an access management program. Functional classification systems establish the planned function of different types of roadways and the priority placed on access as opposed to through traffic movement. Functional classification recognizes that design considerations vary for different classes of roads in accordance with the intended use.

¹ AASHTO. *A Policy on Geometric Design of Highways and Streets (Green Book)*.

² FHWA. *FHWA Functional Classification Guidelines*. 1989

Note: The 1989 version of this publication is available online at

http://www.fhwa.dot.gov/planning/processes/statewide/related/functional_classification/

FHWA, *FHWA 2008 Updated Guidance for the Functional Classification of Highways*, Memorandum from Mary B. Phillips, Associate Administrator for Policy and Governmental Affairs dated October 14, 2008.

Streets and highways are grouped into major classes based on the type or kind of service they provide. The functional classification process is based on the fact that roads are part of a travel network and that “individual roads and streets do not serve travel independently in any major way” (Functional Classification Guidelines, 1989).

The three major functional systems are:

- Freeways;
- Arterials; and
- Collectors and local streets.

Freeway Classification

Freeways can be distinguished from all other roadway systems in that they provide uninterrupted flow. There are no fixed interruptions on freeways. The traffic flow conditions along uninterrupted-flow facilities result primarily from the interactions among vehicles in the traffic stream and between vehicles and the geometric and environmental components of the roadway.

Access to the freeway facility is controlled and limited to ramp locations, whereas access to an interrupted flow facility uses at-grade intersections. Categorization of uninterrupted and interrupted flow relates to the *type* of facility as opposed to the quality of the traffic flow at any given time. A freeway experiencing extreme congestion differs greatly from a non-freeway facility experiencing extreme congestion, in that the conditions creating the congestion are commonly internal to the facility, not external to the facility.

Freeway facilities may have interactions with other freeway facilities as well as other classes of roads in the vicinity. The performance of a freeway may be affected when demand exceeds capacity on these nearby road systems. For example, if the street system cannot accommodate the demand exiting the freeway, over-saturation of the street system may result in queues backing onto the freeway, which adversely affects freeway performance.

Traffic analysts and designers must also recognize that freeway systems have several interacting components, including ramps, and weaving sections. To achieve an effective overall design, the performance of each component must be evaluated separately and the interactions between components must also be considered. For example, the presence of ramp metering affects freeway demand and must be taken into consideration when analyzing a freeway facility.

Arterial Classification

Arterials are a functional classification of roadway transportation facilities that are intended to provide for through trips that are generally longer than trips on collector facilities and local streets. While the need to provide access to abutting land is not the primary function, the design of arterials must also balance this important need. To further highlight the often competing demands of urban arterials, other modes of travel such as pedestrians and public transit are also present and must be accommodated.

To assure that an arterial can safely provide an acceptable level of service (LOS) for the design conditions, a number of design elements must be addressed. Since each design element is essentially determined based on separate analyses, the designer should evaluate the entire arterial system and be prepared to refine certain elements to obtain an effective and efficient overall design.

Arterial systems are often further sub-classified into Principal or Minor arterial functional systems based on the trips served, the areas served, and the operational characteristics of the streets or highways. “Since urban and rural areas have fundamental different characteristics with regards to the density of land use, nature of travel patterns and the number of streets and highway network and the way in which these elements are related, urban and rural functional systems are classified separately as urban principal and minor arterials and rural principal and minor arterials” (FHWA, 1989). These functional systems are therefore discussed individually under the Urban Arterial Classification and Rural Arterial Classification sections below.

Urban Arterial Classification

The AASHTO *Green Book* defines urban areas as those places within the boundaries set by the responsible State and local officials having a population of 5,000 or more. Urban areas are further subdivided into urbanized areas (population of 50,000 and over) and small urban areas (population between 5000 and 50,000) (AASHTO). For design purposes, the designer should use the population forecast for the design year.

There are four functional systems for urban areas:

- **Urban Principal Arterials** - almost all fully and partially controlled access facilities in urban areas are considered urban principal arterials; however, this system is not restricted to controlled access routes. FHWA further stratifies the principal arterial system as: interstate, other freeways and expressways, and other principal arterials with no control of access (Functional Classification Guidelines, 1989).
- **Urban Minor Arterials** - includes all arterials not classified as a principal. This functional system includes facilities that:
 - place greater emphasis on land access than principal arterials and offer a lower level of traffic mobility;
 - interconnect with, and augment, the urban principal arterial system;
 - provide service to trips of moderate length at a somewhat lower level of travel mobility than principal arterials;
 - distribute travel to smaller areas than those of urban principal arterials; and
 - may carry local bus routes and provide intra-community continuity, but ideally should not penetrate identifiable neighborhoods. Note: this system should also include urban connections to rural collector roads where such connections have not been classified as urban principal arterials. (AASHTO Green Book)
- **Collector Streets** – Some characteristics of collector streets are that they:
 - provide access and traffic circulation within residential neighborhoods, commercial, and industrial areas;
 - may penetrate residential neighborhoods, distributing trips from the arterials to destinations; and
 - collect traffic from local streets in residential neighborhoods and channel traffic to the arterial system. (AASHTO Green Book)

- **Local Streets** - Some characteristics of local streets are that:
 - local streets provide direct access to abutting land and access to higher systems; and
 - local street systems offer the lowest level of mobility and usually contain no bus routes. Service to through traffic movement in this system is usually deliberately discouraged.
(AASHTO Green Book)

Rural Arterial Classification

The functional systems for urban arterials and rural arterials differ due to factors such as intensity and type of development that occurs on these systems.

- **Rural Principal Arterials** – almost all fully and partially controlled access facilities in rural areas are considered rural principal arterials; however, this system is not restricted to controlled access routes. Service characteristics of rural principal arterials include:
 - traffic movements with trip length and density suitable for substantial statewide travel or interstate travel;
 - traffic movements between urban areas with populations greater than 25,000;
 - traffic movements at high speeds;
 - divided four-lane roads; and
 - desired LOS B.
- **Rural Minor Arterials** – have the following service characteristics:
 - traffic movements with trip length and density suitable for integrated interstate or inter-county service;
 - traffic movements between urban areas or other traffic generators with populations less than 25,000;
 - traffic movements at high speeds;
 - undivided lane roads;
 - striped for one or two lanes in each direction with auxiliary lanes at intersections as required by traffic volumes; and
 - desired LOS B. (AASHTO Green Book)

Refer to the AASHTO *Green Book*, Chapter 1. New Framework for Geometric Design, for additional information regarding functional classification.

Mapping of roadway functional classifications for all urban and non-urban areas in Georgia is maintained by the GDOT Office of Transportation Data. Functional Classification Maps for Georgia State roadways may be downloaded from GDOT's website at:

<http://www.dot.ga.gov/maps/Pages/HighwaySystem.aspx>

3.2 Design Vehicles

Efficient movement of freight and goods on Georgia's highways is a priority for the Department. The selection of a design vehicle requires the consideration of context, physical and logistic factors and is a key control for the geometric design of roadways and particularly intersections. Design Vehicles are used to define critical features such as lane width, radii at intersections, median and commercial driveway openings, and the radius of turning roadways. Design vehicles should be chosen during the conceptual design phase.

Fundamentally, designs should accommodate the largest vehicle that is likely to use that facility with considerable frequency. Multiple design vehicles may need to be defined for a single corridor or a design vehicle with special characteristics may apply to a single intersection or to a single movement. For example, a vehicle, larger than would otherwise be required on the mainline, may need to be accommodated for a through movement at a cross-road that is a designated truck route. In contrast, a smaller vehicle may be appropriate at a crosswalk where there is high pedestrian activity.

In terms of providing adequate space for trucks, there are two categories of vehicles: Design vehicles and check vehicles. Below are definitions for these two categories of vehicles and an illustration of accommodating and designing for vehicles is shown in Figure 3.1.

Design vehicle – a vehicle which is often accommodated fully within prescribed travel lanes. This may not be possible in relatively tight urban street environments and some latitude may need to be given to encroachment on adjacent lanes approaching and/or departing an intersection.

Check vehicle – an infrequent vehicle, normally larger than the design vehicle, which must be checked to see that it can get through an intersection. A check vehicle will often use all available space including opposing travel lanes and areas outside of travel lanes designed to accommodate off-tracking.

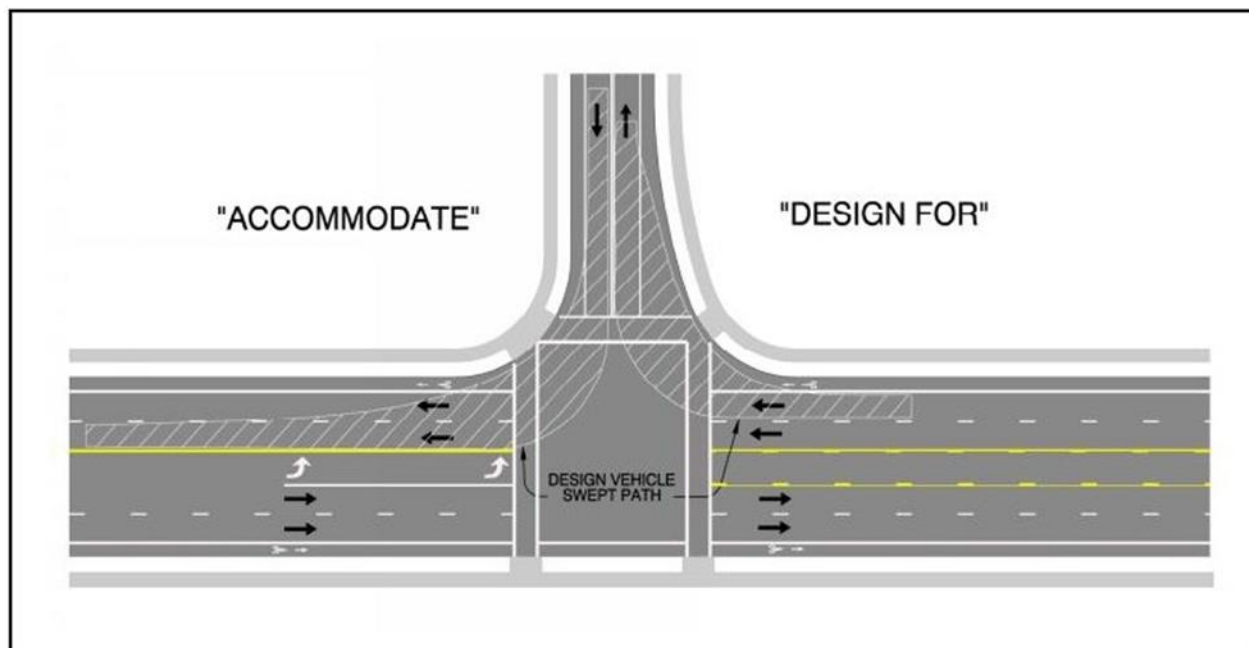

Figure 3.1 Illustration of Accommodating and Designing for Vehicles

The AASHTO Green book provides some guidance on the selection and accommodation of design vehicles, but project-specific decisions should be made based on existing and expected conditions. For roundabouts, refer to **Section 8.3.2 Design Vehicle** and **Section 3.2.6 Accommodation of OSOWs**.

3.2.1. Design Vehicle Types

The four general classes of design vehicles defined by AASHTO are:

- **Passenger Cars** - Passenger automobiles of all sizes, including cars, sport/utility vehicles, minivans, vans, and pick-up trucks;
- **Buses** - Intercity (motor coaches), city transit, school, and articulated buses;
- **Trucks** - Single-unit trucks, truck tractor-semi-trailer combinations, and truck tractors with semi-trailers in combination with full trailers; and
- **Recreational Vehicles** - Motor homes (including those with boat trailers and/or pulling an automobile) and automobiles pulling a camper trailer or a boat trailer.

Refer to the current AASHTO *Green Book Section 2.8, Design Vehicles*, for further discussion and for detailed dimensions of design vehicles.

Another class of vehicle is **Oversize Overweight (OSOW)**. A vehicle may be classified as an OSOW if it is larger than a WB-67 in height, width or length or if it is over the legal weight limit allowed on Georgia roadways, as defined in [Georgia Code Section 32-6-22 to 24](#). Common examples of OSOWs include: long tractor trailers, trucks which carry special loads or very large equipment, mobile homes, low boys, and farm equipment such as combines. Where they apply, an OSOW will often be considered to be a “check vehicle”.

Most projects will include a truck as a design vehicle. Consequently, it is essential to identify the size and type of trucks that will be using an intersection. Current and future use of adjacent property, roadway classification, truck route designation, and the need for a truck to turn at a particular intersection versus taking another more accessible route are some of the information needed to evaluate truck activity.

Table 3.1 Design Vehicles and Typical Design Speeds, lists minimum design vehicles for various roadway functional classifications and roadway types. For *arterials, collectors and local roads*, a *design vehicle should be selected based on actual and projected conditions; therefore, a vehicle larger than the “minimum” listed in Table 3.1 may be required. This decision often requires investigation and input from local stakeholders.* Refer to **Section 3.2.2 Local Input for Selecting a Design Vehicle** of this manual.

Table 3.1 Design Vehicles and Typical Design Speeds

Roadway Type	Design Vehicle	Typical Design Speed (mph) ⁽³⁾
Rural		
Interstate / Freeway Ramp	WB-67	70
Free-Flow	WB-67	35 ⁽¹⁾
Entrance / Exit	WB-67	35 ⁽¹⁾
Loop	WB-67	35 ⁽¹⁾
Principal Arterial	≥WB-40 ⁽²⁾	(See Table 6.6)
Minor Arterial	≥SU ⁽²⁾	(See Table 6.6)
Collector	≥SU ⁽²⁾	(See Table 6.5)
Local Road		
Paved	≥S-BUS36 ⁽²⁾	(See Table 6.4)
Gravel	≥S-BUS36 ⁽²⁾	35
Urban		
Interstate / Freeway Ramp	WB-67	65
Free-Flow	WB-67	35 ⁽¹⁾
Entrance / Exit	WB-67	35 ⁽¹⁾
Loop	≥WB-40 ⁽²⁾	35 ⁽¹⁾
Principal Arterial	≥WB-40 ⁽²⁾	(See Table 6.6)
Minor Arterial	≥WB-40 or ≥BUS-40 ⁽²⁾	(See Table 6.6)
Collector	≥BUS-40 or ≥SU ⁽²⁾	(See Table 6.5)
Residential/Local Road	≥SU or ≥P ⁽²⁾	(See Table 6.4)
⁽¹⁾ Refer to Section 3.3.3 Freeway Exit and Entrance Ramps. ⁽²⁾ Refer to Section 3.2.2 Local Input for Selecting a Design Vehicle. ⁽³⁾ Refer to Section 3.3 Design Speed and Table 6.4 To 6.7. Design Vehicle Type Symbols: BUS=Intercity Bus/Motor Coach, P=Passenger Car, S-BUS=School Bus, SU=Single-Unit Truck, WB=Semi Trailer		

3.2.2. Local Input for Selecting a Design Vehicle

The designer should be aware of all potential types of vehicles that will use each part of the facility and larger vehicles should be accommodated or checked where appropriate. Input from local personnel and stakeholders should be considered when determining the appropriate design vehicle for the mainline roadway, as well as for individual intersections (and driveways) where a different design vehicle or a check vehicle may apply. Local personnel may include the GDOT Area Engineer, Maintenance Engineer, District Access Engineer, District Traffic Operations Engineer, and local government employees or officials. Local industries that are significant traffic generators; such as an automotive assembly plant or a manufacturing plant, should also be considered.

Scenarios where solicitation of local government input is recommended include:

- access between the freeway system and important freight generators, such as marine/inland ports, airports, rail yards, truck stops, distribution centers, and industrial areas;
- roadways which coincide with or cross a locally designated truck route or truck access;
- roadways leading to recreational areas like state parks, campgrounds, and marinas - in which case recreational vehicles, such as motor homes or pick-up trucks with boat trailers, may be the appropriate design vehicle;

- some areas near timber processing facilities - in which case, "long log" trucks (trucks with logs overhanging the trailer by as much as 12-ft.) may be prevalent, as intersections in these areas may require a design that prevents overhanging logs from striking vehicles in other lanes during turning movements. This can usually be accomplished by physically separating the turning lane from adjacent through lanes; and
- school bus routes.

3.2.3. Special Roadways and Networks

Roadways and intersections on the Georgia Oversize Truck Route Network, Georgia Statewide Freight Corridor Network, Strategic Highway Network (STRAHNET), and STRAHNET Connectors should at minimum be designed for a WB-67. The need to accommodate OSOWs should also be evaluated. Each of these networks is briefly described below, and maps of these networks are located at the links provided in the footnotes of this page.

- [Georgia Oversize Truck Routes Map](#)³: this is an oversize truck route network designated by GDOT.
- [Georgia Statewide Freight Corridor Network](#)⁴: this is a network adopted by the state Transportation Board in August 2013 which designates roadways in Georgia that have been prioritized for freight movement.
- [STRAHNET](#)⁵: this is a network of roadways which are important to the United States strategic defense policy and which provide defense access, continuity and emergency capabilities for defense purposes.
- [STRAHNET Connectors](#)⁵: these are roadways which provide access between major military installations and highways which are part of the STRAHNET.

Intermodal Connectors⁶

Intermodal connectors are roadways which provide access between major intermodal facilities and the roadways on the NHS. A design vehicle should be selected which is appropriate for the vehicles which access these facilities.

Industrial Roadways

A WB-67 is recommended for roadways and intersections in industrial areas that carry high volumes of traffic or that provide local access for trucks.

³ <http://www.dot.ga.gov/PartnerSmart/permits/Documents/GaOversizeTrkRouteMap.pdf>

⁴ <http://www.dot.ga.gov/InvestSmart/Freight/Documents/DesignatedFreightCorridor.pdf>

⁵ http://www.fhwa.dot.gov/planning/national_highway_system/nhs_maps/georgia/ga_georgia.pdf. These networks are shown on an interactive NHS Map Viewer located at this link.

⁶ http://www.fhwa.dot.gov/planning/national_highway_system/intermodal_connectors/georgia.cfm. Intermodal connectors are tabulated at this link and can be located using the NHS Map Viewer.

3.2.4 Design Vehicle Turning Paths

The minimum turning path of the selected design vehicle is the primary factor in designing corner radii at intersections, radii of turning roadways, and opening geometry for medians and commercial driveways. The width of raised medians and travel lanes may also be affected. Specifically, the turning radius of the design vehicle can affect the cross-sectional width of a roadway or driveway; in other words, a larger turning radius will require a wider overall roadway cross-sectional width. For example, a semi-trailer truck would need a much larger turning radii at a median opening to properly access a business or commercial distribution center than a passenger car or van.

Design tools that can be used to determine the turning path for a given design vehicle include:

- Published templates which show the wheel paths of a design vehicle, such as the AASHTO Green Book, Figures 2-10 through 2-18 and 2-22 through 2-32, which presents the minimum turning path for 20 typical design vehicles; and
- Vehicle swept path simulation software, such as AutoTURN^{®7}, which works within both MicroStation[®] and AutoCAD[®].

NCHRP Report 505, Review of Truck Characteristics as Factors in Roadway Design provides a detailed analysis of truck characteristics and their effect on various elements of geometric design. Practical information regarding the accommodation of trucks in urban areas is provided in the design guide, *Designing for Truck Movements and Other Large Vehicles in Portland*⁸.

Further discussion of GDOT policies relating to intersection design can be found in **Chapter 7, At-Grade Intersections** and **Chapter 8, Roundabouts** of this manual.

3.2.5 Design Vehicles and Pedestrians

At intersections with high pedestrian activity, the need to accommodate a larger truck may conflict with a need to provide a shorter pedestrian crossing. Refer to **Toolkit 6 Intersections** of the GDOT [Pedestrian and Streetscape Guide](#)⁹ for information relating to balancing the needs of trucks and pedestrians.

3.2.6. Accommodation of OSOWs

The need to accommodate for OSOWs is based on permit data, local input, the context, and whether or not the route is on a special roadway or network. Accommodation of OSOWs must be specifically evaluated for the design of all roundabouts located either on the NHS or on a state route. Accommodation of OSOWs should also be evaluated for a traditional intersection on the NHS or a state route if the intersection has restrictive geometry. An example of restrictive geometry that may require consideration would be a narrow intersection approach that has medians and curbs on both sides. Vehicles which exceed maximum size limitations defined in [Georgia Code Section 32-](#)

⁷ AutoTURN[®] is developed by Transoft Solutions. Additional information about this software application is available online at: <http://www.transoftsolutions.com/ProductTmpl.aspx>

⁸ <https://www.portlandoregon.gov/transportation/article/357099>

⁹ <http://www.dot.ga.gov/PartnerSmart/DesignManuals/TrafficOps/GDOT%20Pedestrian%20and%20Streetscape%20Guide.pdf>

[6-22 to 24](#) require permits to operate on the National Highway System (NHS). A request can be made to obtain a tabulation of permitted oversize vehicles which have passed through a specific intersection. This tabulation will help evaluate the direction, frequency, size and weight of permitted loads. Requests may be sent to OSOW@dot.ga.gov to obtain permit data for a specific intersection.

3.3. Design Speed

3.3.1. General Considerations

“Design Speed” has been identified as a "controlling criteria" that has substantial importance to the operational and safety performance of a roadway such that special attention should be given to the design decision. Therefore, GDOT adopts the AASHTO Green Book, “A Policy on Geometric Design of Highways and Streets,” and the AASHTO “A Policy on Design Standards – Interstate System” as the standard for design speed options for roadway classifications in Georgia. A decision to use a design speed value that does not meet the controlling criteria defined by AASHTO shall require a comprehensive study by an engineer and the prior approval of a Design Exception from the Department’s Chief Engineer.

Design speed is different from other controlling criteria in that it is a design control, rather than a specific design element. In other words, the selected design speed is used to establish a range of design values for many of the geometric elements of a roadway. The selected design speed should be a logical one with respect to the topography, anticipated operating speed, the adjacent land use and functional classification of the roadway. Design speed should be consistent with the speeds at which 85 percent of drivers are traveling (referred to as the 85th percentile) and likely to expect on the facility.

In recognition of the wide range of site-specific conditions, constraints, and contexts for roadways AASHTO defines a range of values for design speed. A design speed that is as high as practical that will provide safety, mobility, and efficiency within the constraints of environmental quality, economics, aesthetics, and other social or political effects should be selected. Table 3.1. lists typical design speeds which should be considered when selecting an appropriate design speed.

On county roads or city streets, GDOT recommends coordination with the local jurisdictional authority to identify posted speeds on existing roadways and for the selection of the posted speed limit and the design speed for new or reconstructed roadways.

3.3.2. Intersections Approaching a Stopped Condition

To improve the angle of intersection between a local street and major road, a designer may use a lower design speed on the local street for curves approaching an intersection if it is not anticipated that the T-intersection will become a full intersection.

The design speed of the last curve prior to the intersection may be 10 mph less than the design speed of the local street.

3.3.3. Freeway Exit and Entrance Ramps

Typical freeway exit and entrance ramps may have varying design speeds which are based on the operating speed of the vehicle as it decelerates or accelerates on the ramp. A common rule to apply for ramps is that the design speed of the first curve of an exit ramp can be assumed to be 10 mph

less than the design speed of the mainline. With each successive curve on the exit ramp, the design speed of the curve can be reduced based on computed vehicle deceleration. The reverse condition applies to the design speed for all entrance ramps.

The design speed for a direct system to system ramp that connects two freeway facilities should be no less than 10 mph below the design speed of the exiting facility.

On loop ramps, adequate deceleration length should be provided prior to the loop part of the ramp. All areas of deceleration should be separated from the mainline lanes. System to system loop ramps will be evaluated on a case-by-case basis.

3.3.4. Urban Subdivision Streets

In most cases, the design speed for urban subdivision streets should be a minimum of 25 mph.

3.4. Highway Capacity

All portions of roadways that are part of major construction or reconstruction should be designed to accommodate, at a minimum, 20-year forecasted traffic volumes. The design year for the 20-year traffic volumes should be forecasted from the estimated base (or opening) year, which is the year the project is anticipated to be open for traffic use. Refer to **Chapter 13, Traffic Forecasting and Analysis Concepts**, of this Manual for further discussion on the traffic engineering and analysis.

If a project is not new roadway construction or reconstruction, refer to **Chapter 11, Other Project Types** for guidance relating to other project types.

3.5. Establishment of Access Control

3.5.1. Definitions

GDOT has adopted the following “Access Control” criteria as standard, having substantial importance to the operational and safety performance of a roadway such that special attention should be given to design decisions. The designer is encouraged to select design elements and features that are consistent with the access control plan established for a roadway. A decision to use a design element or feature that does not meet the standard access control criteria defined by GDOT shall require a comprehensive study by an engineer and the prior approval of a Design Variance from the Department’s Chief Engineer.

Roadways serving higher volumes of regional through traffic require greater access control to preserve their mobility function. Frequent and direct property access is more compatible with the function of local and collector roadways. The regulation of access to a roadway is referred to as “access control”. It is achieved through the regulation of public access rights to and from properties abutting the roadway facilities. The [Official Code of Georgia Annotated](#) (OCGA)¹⁰ § 32-6-111 to - 114 give GDOT this authority.

The regulation of public access rights is generally categorized as either full control of access, partial control of access, or control of access by permit (or permitted access).

¹⁰ Online public access to the Official Code of Georgia Annotated (OCGA) is provided at: <http://w3.lexis-nexis.com/hottopics/gacode/Default.asp?loggedIn=done>

Full control of access means that preference is given to through traffic by providing access connections by means of ramps with only selected public roads and by prohibiting crossings at grade and direct driveway connections.

Partial control of access means that some preference should be given to through traffic. Access connections, which may be at-grade or grade-separated, are provided with selected public roads and private driveways. In areas with partial control of access, the decision to grant access to private driveways is made at the time of project development, and thereafter, private driveway access should not be added.

Permitted **access** means that a permit is needed for access. A permit is required prior to performing any construction work or non-routine maintenance within the State highway right-of-way. This includes but is not limited to the following activities: grading, landscaping, drainage work, temporary access to undeveloped land for logging operations, or construction of a development. Any new driveway or revisions to any portion of existing driveways, i.e. widening and/or relocation that are within the State roadway right-of-way shall also require a permit.

3.5.2. Access Management

The following standards shall be used to establish access control:

Full control of access

- Full control of access shall be established on all Interstates.
- Full control of access shall be established on principal arterials constructed on new location with grade separated interchanges.
- For projects that involve an Interstate interchange, (new construction or reconstruction), access control should be established along the intersecting route for a distance of 600-ft. in urban areas and 1,000-ft. in rural areas, where practical. At a minimum, access control shall not be less than 300-ft. This distance is measured from the radius return of the ramp termini with the intersecting route. (See Figure 3.1, Limit of Access Control Interstate/Freeway Interchange).
- Where improved traffic operations and safety warrant, existing driveways may be closed and no access allowed to developed or undeveloped property. Decisions on elimination of access points should be based in part on an economic study of alternate courses of action.

Partial control of access

- Partial control of access shall be established on principal and minor arterials that are constructed on a new location with intersections at-grade. Access control should not be established on portions of projects on new location which are less than one mile in length, unless the project connects to a section of roadway where access control has been or will be established or where required to preserve the functional area of an intersection as described below.
- Partial control of access should be established on existing principal arterials that are being widened; when it is determined that partial access control is advisable. On this type of project, every attempt shall be made to consolidate existing access to the roadway by

developing a supporting roadway network. All undeveloped property frontage should be treated in the same manner as new location construction.

Breaks in access will only be considered for the following conditions:

- State or local government public road intersections
- Where property from existing roadways has been bisected by the new roadway alignment and no other access is provided and the appraised damages to the remaining property exceed \$100,000. Coordination with the District office should be performed prior to making a request for a break in access control. Procedures for the Evaluation for Breaks in Access Control can be found in Chapter 6 of the [Plan Development Process \(PDP\) Manual](#). **All breaks in access control under the given conditions must have prior approval of a Design Variance from the Department's Chief Engineer.**

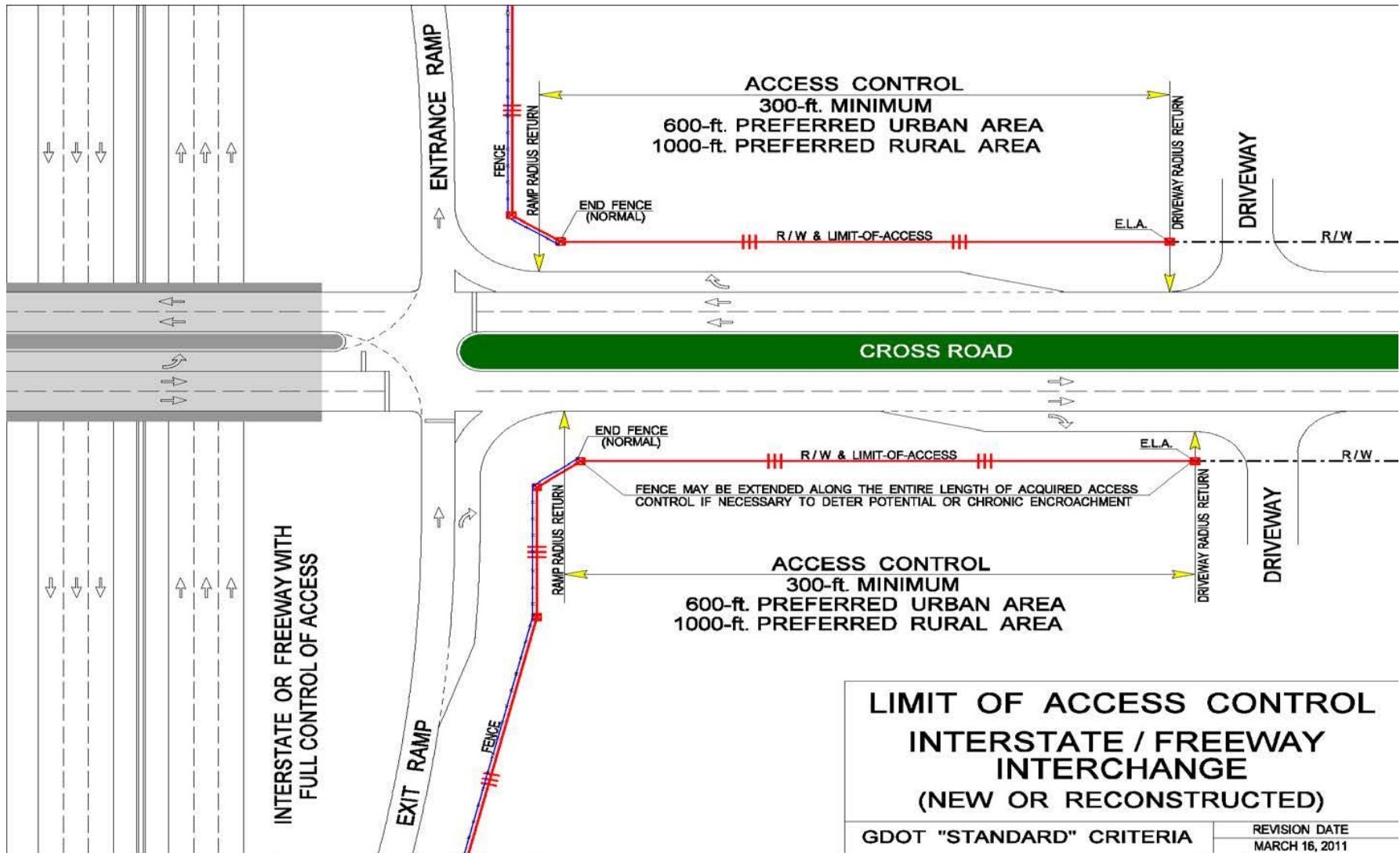

Figure 3.1 Limit of Access Control Interstate/Freeway Interchange

Permitted access

- On principal and minor arterials and major collector roadways that are being reconstructed, access rights should be acquired so that driveway connections are not allowed within the functional area of any intersection. The functional area of an intersection is the area where motorists are responding to the intersection, decelerating, and maneuvering into the appropriate lane to stop or complete a turn. Access connections too close to intersections can cause serious traffic conflicts that impair the function of the affected facility.
- Upstream functional distance is defined as the distance traveled during perception-reaction time, plus the deceleration distance while the driver maneuvers to a stop, plus the queue storage. Downstream functional distance is defined as the stopping sight distance.

Temporary State Routes

For routes that are temporarily placed on the state route system during project development, close coordination to determine the appropriate access control should occur between the Department and the local government responsible for enforcing the access control after the oversight reverts back to the local government. "Permitted Access" should be considered when there is a strong likelihood that access breaks will be requested by potential development along the route. "Full Control of Access" or "Partial Control of Access" should be considered when the project connects to a section of roadway where similar access control has been or will be established, and to preserve the functional classification of the route or corridor. Before Right of Way acquisition begins, it is recommended that the Department receive written confirmation from the local government to enforce the established access control after the oversight reverts back to the local government.

3.5.3. Right of Way (R/W) and Limit of Access (L/A) Line Descriptions

To ensure the consistent and accurate application of required/existing Right-of-Way (R/W) and required/existing Limit of Access (L/A) information on Right of Way and Construction plan sheets, the following descriptions and example figure showing the line descriptions are displayed below:

- Existing R/W line represents where property is currently owned, maintained, and used by the State Department for a public roadway. See the Definition of Terms section in the Design Policy Manual (DPM) and the GDOT Driveway Manual.
- Required R/W line represents where property is needed by the State Department for the construction, maintenance, and use of a proposed public roadway. See the Definition of Terms section in the DPM and the GDOT Driveway Manual.
- Existing L/A line represents where the existing limit of access is NOT common with the existing R/W. For example, where an existing frontage road (access permitted) is adjacent to an Interstate road (limited access), the Existing L/A line would be placed between the interstate and the frontage road. See Figure 3.2.
- Required L/A line represents where required L/A is not common with required R/W. For example, where a frontage road (access permitted) is proposed adjacent to an interstate road (limited access), the Required L/A line would be placed between the interstate and the frontage road. See Figure 3.2.

- Existing L/A & R/W line represents where existing L/A is common with existing R/W, for example, along an existing interstate route with no frontage road. See Figure 3.2.
- Required L/A & R/W line represents where the required L/A is common with the existing or required R/W (whichever is the final R/W for the project). See Figure 3.2.

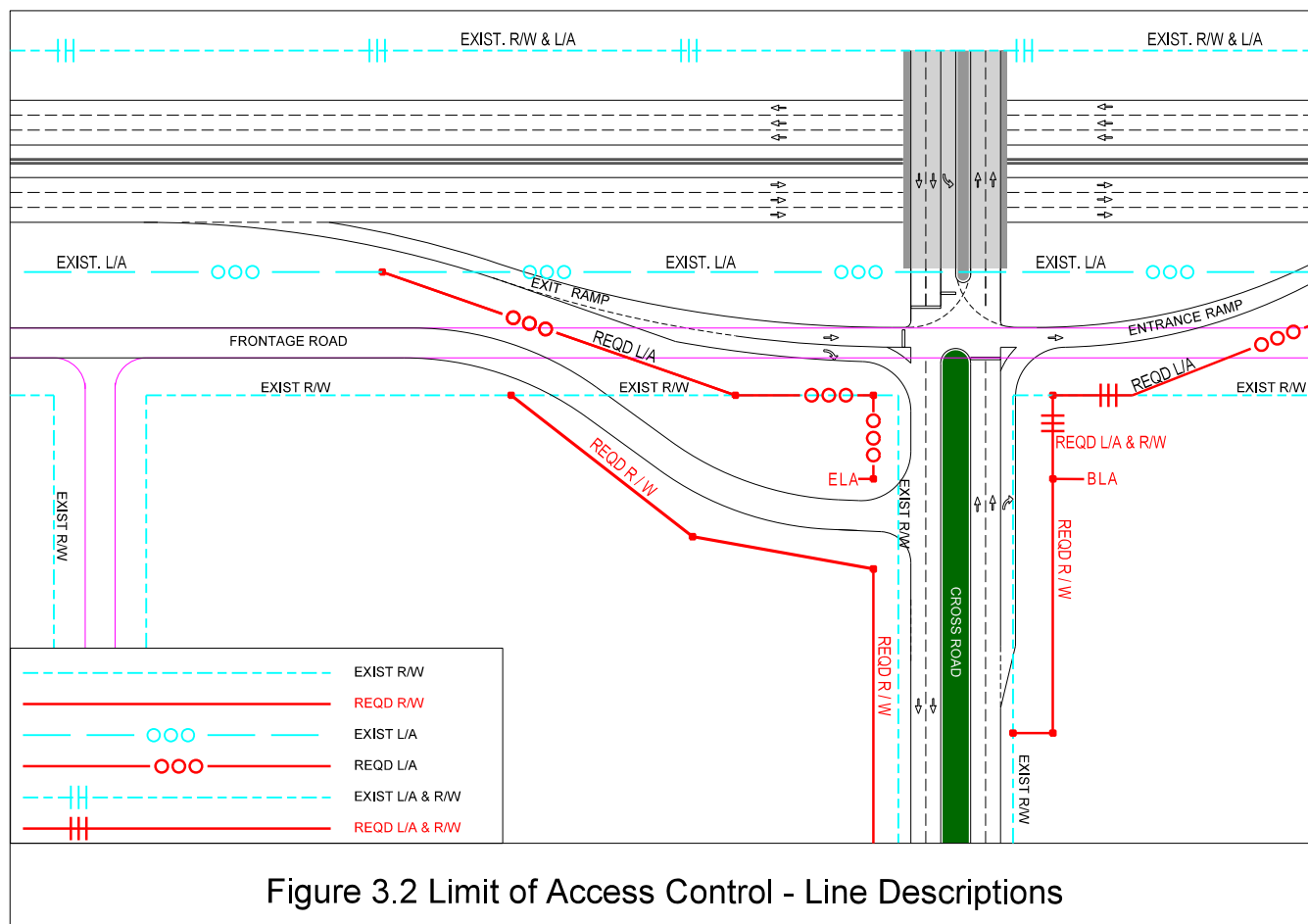

Figure 3.2 Limit of Access Control - Line Descriptions

3.6. Frontage Roads and Access Roads

AASHTO defines frontage roads as roads that “segregate local traffic from the higher speed through traffic and intercept driveways of residences and commercial establishments along the highway” (AASHTO *Green Book*). Frontage roads can serve many functions depending on the type of arterial they serve and the character of the surrounding area. They are commonly used to control access to the arterial, to provide access to adjoining properties, and to maintain traffic circulation on each side of the arterial.

Most existing frontage roads were built along interstate or major arterial routes to control access to these routes and provide access to property that would otherwise be land-locked. Access roads may also be used to provide access to landlocked parcels.

Frontage roads typically run parallel to the mainline route while access roads provide access to individual properties and may not run parallel to the mainline. Access roads and frontage roads

should be offset from the mainline route to allow required clear zone and future roadway widening, if anticipated

3.7. Fencing

The Georgia Department of Transportation has established the following guidelines for installing fence on state right-of-way and/or private property associated with the design of roadway projects. These guidelines are based on the principles published in the AASHTO *An Informational Guide on Fencing Controlled Access Highways* (1990).

3.7.1 Fencing on State Right-of-Way

Fencing is provided within the state right-of-way to delineate the boundary of the acquired access control, and as a physical obstacle to deter encroachment onto the roadway right-of-way from children, pedestrians, bicyclist, vehicles, machinery, and animals. Fencing may also be provided to deter access into or across specific features within the right-of-way such as drainage structures, bridges and retaining walls. The following guidelines are provided for the consistent application of fencing on state right-of-way.

- Roadways with Full Control of Access are expected to provide a higher level of mobility and operate at higher speeds with protection from all forms of roadside interference. Therefore, fencing should be installed within the state right-of-way on roadways with Full Control of Access, where it is practical to do so. Fencing may not be practical or necessary in areas with steep slopes or natural barriers.
- Fencing may be installed within the state right-of-way on roadways with Partial Control of Access or any portion of a state route with an acquired limit-of-access if the Department determines it necessary to deter potential or chronic encroachment.
- For roadways with Full Control of Access and parallel frontage roads included within the state right-of-way, fencing should be installed between the mainline traveled-way and the frontage road. In these cases, it may not be necessary to install a duplicate fence along the right-of-way line.
- Fence installed within the state right-of-way to delineate the limit-of-access should be offset a minimum of 1-ft inside the right-of-way line to ensure there is adequate space for installation and maintenance.
- For non-access grade separations, fence installed along the limit-of-access will be terminated at the points where the state right-of-way intersects the normal right-of-way of the crossing grade separation.
- For grade separated interchanges, fence installed along an entrance or exit ramp terminal with a cross road should terminate at the point where the state right-of-way intersects the normal right-of-way along the cross road. Fencing may be extended along the right-of-way of the cross road for the entire length of acquired access control if the Department determines it necessary to deter potential or chronic encroachment (see **Figure 3.1, Limit of Access Control Interstate/Freeway Interchange**).

- Fence installations within the state right-of-way are not intended to control livestock from adjacent private property and should not be installed or permitted for this reason. Where fencing is required to contain livestock within adjacent private property, an independent fence on private property will be required for that purpose (see **3.7.2. Fencing on Private Property**).
- The installation of 6-ft height Chain Link Wire Fence should be considered on a case-by-case-basis around the perimeter of proposed permanent drainage features that will contain water over 24-inches deep for an extended period of time (greater than 48 hours). For example, natural ponds, detention ponds and water quality ponds within the state right-of-way. The fence should be installed with adequate space for routine maintenance and equipped with self-closing and self-latching gates.
- A fence or handrail should be considered on a case-by-case-basis along the top of a retaining wall with a change in elevation of 30-inches or more above the grade below. These cases should be assessed independent of fencing along a limit-of-access.

For guidance on the design and installation of fence or handrail on bridges, refer to *Chapter 3.3 of the GDOT Bridge and Structures Design Policy Manual*.

http://www.dot.ga.gov/PartnerSmart/DesignManuals/BridgeandStructure/GDOT_Bridge_and_Structures_Policy_Manual.pdf

For guidance on the construction of fencing, refer to GDOT Construction, *Standard Specification, Section 643 – Fence*. <http://www.dot.ga.gov/PartnerSmart/Business/Source/specs/ss643.pdf>

The Department has established the following guidelines to determine the type of fencing installation appropriate for the access control along the roadway.

Full Control of Access:

Urban Interstate or Freeway:

- Ga. Standard Detail 9031-N, Chain Link Wire Fence – heavier gage fence typically 6-ft. height – typically used in areas with restricted cross section and limited (narrow) space between the roadway and the right-of-way, such as depressed urban freeways with retaining walls and significant changes in vertical elevation between the roadway and right-of-way – may include extension arms with barbed wire strands across the top to enhance security.

Suburban Interstate or Freeway:

- Ga. Standard Detail 9031-N, Chain Link Wire Fence or,
- Ga. Construction Detail F-1, Woven Wire Fence – 4-ft. height wire mesh with barbed wire strand along the top and bottom – may be used in areas with flatter more rounded sideslopes and wider (more adequate) space between the roadway and the right-of-way.

Rural Interstate or Freeway:

- Ga. Construction Detail F-1, Woven Wire Fence or,

- Ga. Construction Detail F-6, Game Fence – typically 8-ft height mesh with barbed wire strands along the top and bottom - may be used on portions of roadways to reduce crash rates related to wild game crossing.

Partial Control of Access or any portion of a roadway with an acquired limit-of-access:

- Ga. Standard Detail 9031-N, Chain Link Wire Fence or,
- Ga. Construction Detail F-1, Woven Wire Fence or,
- Ga. Construction Detail F-6, Game Fence

3.7.2 Fencing on Private Property

In cases where the Department is acquiring additional right-of-way or easement, and displacing fence on private property, the value of “replacement fencing” will be assessed by the right-of-way agent for settlement with the property owner.

Replacement fencing may be installed by the Department’s contractor or by the property owner on private property, as determined in the settlement with the property owner and noted on the plans.

Fence installed on private property should be offset a minimum of 1-ft outside the state right-of-way line. Typically a 5-ft wide temporary “Easement for the Construction of Fence” will be required on private property if the fence is installed by the Department’s contractor.

Replacement fencing on private property may consist of chain link wire, woven wire, field fencing/barbed wire, ornamental, or specialty type fencing including gates and associated hardware. In cases where ornamental or specialty fencing is included as a contract item, a special provision with detail drawings will be required in the plans and contract proposal.

A decision to provide replacement fencing on private property will be made during right-of-way acquisition. Designers should coordinate with the Right-of-Way Acquisition Manager for direction on replacement fencing on private property prior to establishing temporary easements or adding notes to the plans.

For additional guidance involving the installation of fence on private property refer to the GDOT Right-Of-Way Manual, currently maintained by the Office of Right-Of-Way in hard-copy format.

3.8. Right-of-Way Controls

Establishing right-of-way widths that adequately accommodate construction, utilities, drainage, and proper roadway maintenance is an important part of the overall design. The border area between the roadway and the right-of-way line should be wide enough to serve several purposes, including provision of a buffer space between pedestrians and vehicular traffic (if applicable), roadway drainage, sidewalk space, lateral offset, clear zone, and an area for both underground and aboveground utilities. A wide right-of-way width allows construction of gentle slopes and also allows for utility poles to be offset further from the road, which in turn results in greater safety for motorists as well as easier and more economical maintenance of the right-of-way.

3.8.1. Rural Areas

In hilly terrain, construction limits vary considerably as the roadway passes through cut and fill sections. In these situations, the required right-of-way will likely vary, so it may be impractical to use a constant right-of-way width.

In flat terrain, it is usually both practical and desirable to establish a minimum right-of-way width that can be used throughout most of the project length. Required right-of-way widths should be set at even offsets from the centerline, typically multiples of 5-ft., unless some physical feature requires otherwise.

As a general rule, the required right-of-way line should be set a minimum of 7-ft. to 10-ft. beyond the proposed limits of construction in cut and 10-ft. to 15-ft. beyond the proposed limits of construction in fill. In areas of high fills a minimum of 20-ft. should be provided beyond the construction limits to provide room for adequate erosion control Best Management Practices (BMPs) that are necessary to minimize sediment transport. Extra right-of-way at the top of cut slopes should be provided for the construction of ditches that will intercept surface drainage and help minimize slope erosion.

If a future project will potentially connect to either end of the proposed project, the required right-of-way line is extended to the nearest property line beyond the extent of construction, if practical. This is done to avoid buying right-of-way from the property owner on two different occasions. In this case, the project limit will correspond to the limit of the required right-of-way.

3.8.2. Urban Areas

In urban areas, right-of-way widths are governed primarily by economic considerations, physical obstructions, utility conflicts or environmental considerations. Along any route, development and terrain conditions may vary affecting the availability of right-of-way.

Property or environmental impacts may limit the amount of right-of-way that can realistically be acquired. In urban areas, it may be appropriate to set the required right-of-way at the shoulder break point to minimize impacts. However, required lateral offset, specified in **Chapter 5** of this manual, should be considered when setting the required right-of-way. Also, permanent roadway features such as roadway ditches, drainage structures, steep fill slopes and back slopes, sight triangles at intersections, horizontal sight distance, etc. should be within the required right-of-way.

3.8.3. Special Types of Right-of-Way

Construction Easement

Construction easement is called for on the plans when an area outside the required right-of-way line is needed only during construction of the project. The most common example of this is for construction of a temporary detour road.

A permanent feature should not be placed in a construction easement. The decision to obtain permanent right-of-way or construction easement is made after considering the circumstances of each project.

The property owner is paid a fee during the time the construction easement is needed. Where applicable, the owner is also paid for damages that may be incurred during the construction process such as for removal of trees or shrubbery.

Permanent Drainage Easement

Drainage easement is required when a new lateral outfall ditch is to be constructed beyond the right-of-way or when an existing lateral outfall ditch is to be improved outside of the right-of-way. Drainage easement is obtained when construction of these laterals is critical to proper drainage of the project. As with a construction easement the property owner is paid for use of the drainage easement, and for damages resulting from construction. However, with drainage easements GDOT reserves the right of permanent access to the drainage structure for maintenance purposes.

Easement for Construction, Maintenance, and Removal of Sediment Basin

Temporary sediment basins should be placed completely within permanent easement, where practical. Constructing temporary sediment basins on permanent easement avoids potential conflicts with utilities and with construction activities. Where it is not practical to locate a sediment basin inside permanent easement (e.g., due to surrounding environmental constraints), it is preferred that the sediment basin be placed completely within the right-of-way.

In special cases a temporary sediment basin may be placed on both right-of-way and permanent easement if no other geometric layout is feasible. In this case, the engineer must verify that the layout does not conflict with utilities and/or construction activities.

Permanent easement for a temporary sediment basin may be converted to temporary easement during right-of-way negotiations.

Easement for Temporary Bridge Construction Access

Temporary construction access may be required to build a bridge on a project. The need for temporary construction access should be coordinated with the Office of Bridge Design and the Office of Construction. Sufficient easement should be provided for the type of temporary construction access used on the project and any impacts to waters of the US due to temporary construction access must be covered in the 404 permit.

Control of Access

Access rights may be purchased from property owners along major roadways having full or partial access. No roadway access crossing the limited access is allowed and the property owner is compensated for such restrictions. Where limited access is used along a roadway, it typically extends down intersecting roadways to enhance traffic flow at the intersection.

Easement for Maintenance of Retaining Walls

Permanent easement of 10-ft from the face of a retaining wall is required when walls greater than 4-ft tall are used in lieu of a fill slope. Limits of this easement should extend beyond the limits of the wall as necessary to provide access from Department Right of Way.

3.8.4. Accommodating Utilities

In addition to primarily serving vehicular traffic, right-of-way for streets and highways may accommodate public utility facilities in accordance with state law or municipal ordinance.

The use of right-of-way by utilities should cause the least interference with traffic using the street. If existing utilities are in conflict within areas of restricted right-of-way, discussions should be held at the Field Plan Review to determine how to adequately accommodate utility relocations. Utility

features, such as power poles and fire hydrants, should be located as close to the right-of-way line as feasible for safety reasons.

Utilities located within the limits of construction for the roadway and drainage structures of a project may require relocation, adjustment, or encasement. The surveys should identify the utility locations, elevations, types, sizes, and owners. The plans and cross-sections will then be used to inform utility owners of how the project will impact their facilities.

Relocated utilities should normally be accommodated within the required right-of-way. This should be considered in setting required right-of-way limits.

For GDOT policies related to accommodating utilities, the designer should refer to the GDOT Utility Accommodation Policy and Standards Manual, which is available at <http://www.dot.state.ga.us/doingbusiness/utilities/Pages/manual.aspx>

3.9. Value Engineering

Value Engineering (VE) is defined in Code of Federal Regulations (CFR) Title 23 Part 627as follows:

"the systematic application of recognized techniques by a multi-disciplined team to identify the function of a product or service, establish a worth for that function, generate alternatives through the use of creative thinking, and provide the needed functions to accomplish the original purpose of the project, reliably, and at the lowest life-cycle cost without sacrificing safety, necessary quality, and environmental attributes of the project ()

For GDOT guidelines, policies and further information related to VE studies, the designer should refer to the current GDOT PDP, which is available in the "Other Design Related Links and Resources" section of the GDOT Repository for Online Access to Documentation and Standards (ROADS). Any applicable Design Exceptions and Design Variances shall be obtained prior to the implementation of a VE study recommendation which deviates from design standards adopted or defined by this policy.

3.10. Environmental

To the extent practical, roadways should be designed to fit into the surrounding landscape and environment. This approach helps to minimize potential impacts to the built and natural environment. Some environmental factors to consider in highway design include:

- surrounding land uses and landscape elements;
- historic and cultural resources;
- important community features;
- wetlands, streams and other natural resources;
- utilities and potentially contaminated sites that are close to the roadway; and
- airports and aviation facilities (located within 5 miles of the project).

GDOT encourages proactive coordination with local, and state or federal resource and regulatory agencies to identify important resources that may be of concern on a design project. Various techniques can be used to facilitate coordination with local jurisdictions. Several techniques are

detailed in the GDOT *Context Sensitive Design Manual*, Section 2.2. Understand Community Input and Values.

Sometimes there are opportunities for a roadway project to enhance the surrounding environment. Refer to the GDOT Environmental Procedures Manual as well as the GDOT *Context Sensitive Design Manual*, Section 2.3. Achieve Sensitivity to Social and Environmental Concerns, for further guidance in this area.

While designing a roadway or major highway alignment so that it complements the surrounding terrain is an important consideration, any deviation from AASHTO or GDOT design policy standards shall require a Design Exception or Design Variance. Care should be exercised to ensure that applicable local, state, and federal environmental regulations are met in accordance with the project environmental document.

Intentionally Left Blank

Chapter 4. Elements of Design - Contents

Chapter 4. Elements of Design - Contents	4-i
4.1 Sight Distance	4-1
4.1.1. General Considerations.....	4-1
4.1.2. Stopping Sight Distance	4-1
4.1.3. Passing Sight Distance	4-2
4.1.4. Decision Sight Distance	4-2
4.1.5. Intersection Sight Distance.....	4-2
4.1.6. Intersection Skew Angle.....	4-3
4.2 Horizontal Alignment	4-4
4.2.1. General Considerations.....	4-5
4.2.2. Types of Curves	4-6
4.2.3. Pavement Widening on Curves.....	4-9
4.2.4. Lane Width Transitions and Shifts.....	4-10
4.2.5. Transition in Number of Lanes	4-12
4.3 Vertical Alignment.....	4-14
4.3.1. General Considerations for Vertical Alignments.....	4-15
4.3.2. Maximum Vertical Grades	4-16
4.3.3. Minimum Vertical Grades	4-18
4.3.4. Vertical Curves	4-20
4.3.5. Maximum Change in Vertical Grade without Using Vertical Curves.....	4-21
4.3.6. Vertical Grade Changes at Intersections.....	4-22
4.3.7. Minimum Profile Elevation Above High Water.....	4-22
4.3.8. Reporting Changes in Vertical Clearances	4-23
4.4 Combined Horizontal and Vertical Alignments	4-24
4.4.1. Aesthetic Considerations.....	4-24
4.4.2. Safety Considerations	4-24
4.4.3. Divided Highways.....	4-25
4.5 Superelevation.....	4-26
4.5.1. Superelevation Rate.....	4-26
4.5.2. Sharpest Curve without Superelevation	4-28
4.5.3. Axis of Rotation	4-28
4.5.4. Superelevation Transitions.....	4-29

Chapter 4. Elements of Design

4.1 Sight Distance

4.1.1. General Considerations

A detailed explanation of how to apply the sight distance criteria to a roadway is described in the American Association of State Highway and Transportation Officials (AASHTO) publication, *A Policy on the Geometric Design of Highways and Streets (Green Book)*, Chapter 3, Elements of Design. In addition, Chapter 9 of the *Green Book (Intersections)* discusses special conditions related to sight distance at intersections.

General considerations relating to sight distance noted in the AASHTO *Green Book* include:

- Safe and efficient operation of a vehicle is highly dependent on adequate sight distance.
- Two-lane rural highways should generally provide sufficient passing sight distance at frequent intervals and for substantial distances. Conversely, passing sight distance on two-lane urban streets/arterials is normally of little value.
- The proportion of a highway's length with sufficient sight distance to pass another vehicle and interval between passing opportunities should be compatible with design criteria pertaining to functional classification, as discussed in this Manual in **Chapter 2, Design Policies and Standards**.
- Special consideration should be given to the sight distance requirements at queue backups over a hill, signals, horizontal curves, turning movements, barriers, guardrails, structures, trees, landscaping, vegetation and other special circumstances.

4.1.2. Stopping Sight Distance

“Stopping Sight Distance” has been identified as a "controlling criteria" that has substantial importance to the operational and safety performance of a roadway such that special attention should be given to the design decision. Therefore, GDOT adopts the AASHTO Green Book, “A Policy on Geometric Design of Highways and Streets,” and the AASHTO “A Policy on Design Standards – Interstate System” criteria as the standard for Stopping Sight Distance for roadways in Georgia. A decision to use a Stopping Sight Distance value on horizontal curves and crest vertical curves that does not meet the minimum controlling criteria defined by AASHTO shall require a comprehensive study by an engineer and the prior approval of a Design Exception (high speed roadways) or Design Variance (low speed roadways) from the Department’s Chief Engineer.

Designers should note that the values for Stopping Sight Distance listed in the AASHTO Green Book are minimum values based on a 2.5 second brake reaction time. Larger stopping sight distance values may be considered by the designer, within the constraints of economic, environmental, social, and other influences. GDOT encourages designers to consider using greater values for Stopping Sight Distance when practical. Methods for scaling sight distances on plans are demonstrated in Figure 3-1 of the AASHTO *Green Book* (2018).

Stopping sight distance across the inside of curves plays a critical role in determining roadway horizontal curvature and applicable shoulder widths. Enough right of way should be purchased to

ensure that adequate stopping sight distance is maintained. There should be no obstruction of sight lines on the inside of curves (such as median barriers, walls, cut slopes, buildings, landscaping materials, and longitudinal barriers). If removal of the obstruction is impractical to provide adequate sight distance, a design may require adjustment in the normal highway cross section or a change in the alignment.

Because of the many variables in alignment, cross section, and in the number, type, and location of potential obstructions, the actual conditions on each curve should be checked and appropriate adjustments made to provide adequate sight distance. The AASHTO *Green Book* (2018), Figure 3-13 Diagram Illustrating Components for Determining Horizontal Sight Distance, provides additional information on the effects of obstructions located on the inside of horizontal curves. Refer to the AASHTO *Green Book* (2018) for guidelines on meeting the minimum Sag Vertical Curves Stopping Sight Distance requirements.

4.1.3. Passing Sight Distance

Passing sight distance is the sight distance needed for passing other vehicles (applicable only on two-way, two-lane highways at locations where passing lanes are not present).

4.1.4. Decision Sight Distance

Decision Sight Distance is the distance needed for a driver to detect an unexpected or otherwise difficult-to-perceive information source or condition in a roadway environment that may be visually cluttered, recognize the condition or its potential threat, select an appropriate speed and path, and initiate and complete the maneuver safely and efficiently. Examples of locations where Decision Sight Distance should be considered are: multiphase at-grade intersections, six-lane roadways with at-grade intersections, interchanges, ramp terminals on through roadways, lane drops, and areas of concentrated traffic demand where there is likely to be more visual demands and heavier weaving maneuvers.

The use of AASHTO *Green Book* criterion for Decision Sight Distance is encouraged by GDOT and should be considered at appropriate locations along a roadway. In cases where it is not practical to provide Decision Sight Distance, then Stopping Sight Distance shall be provided.

4.1.5. Intersection Sight Distance

Intersection Sight Distance has been identified by the Department as having substantial importance to the operational and safety performance of a roadway such that special attention should be given to the design decision. Therefore, GDOT adopts the AASHTO *Green Book* criteria as the standard for Intersection Sight Distance. Refer to the *AASHTO Green Book, Chapter 9, Intersections*, for design criteria applicable to the traffic control conditions of an intersection. If it is not practical to provide an intersection sight distance value defined by AASHTO, then a decision to select a value or retain an existing condition that does not meet the criteria defined by AASHTO shall require a comprehensive study by an engineer and the prior approval of a Design Variance from the GDOT Chief Engineer.

Appropriate calculations and graphical studies needed to verify adequate intersection sight distance shall be conducted by the engineer and recorded in the design data book. The *Green Book* defines ten analysis cases for seven types of intersection control. All valid cases which apply to the planned

control for the intersection must be evaluated. These studies should be performed during preliminary design when both the horizontal and vertical alignments are being finalized.

Graphical studies, at a minimum, should include scaled distances on plan and profile sheets and may at times necessitate plotting the sight line location on specific cross-section sheets. An example of plan and profile records (in the context of *stopping sight distance*) is provided in Figure 3-1 of the AASHTO *Green Book* - 2018. Graphical studies are often needed for the following conditions:

- minor road alignment in skew;
- mainline in horizontal curve;
- mainline with crest vertical curve on either side of intersection;
- mainline and/or minor road within a cut; and
- areas where vegetation growth may obstruct the sight triangles (i.e. grass medians).

Intersection Sight Distance is critical for urban sections with narrow shoulders and limited right-of-way where obstructions on private property may encroach into the sight triangles. Special consideration should be given to obstructions within the right of way such as: bridges, retaining walls, signs, landscaping, signal control boxes, guardrail, etc. Where a sight line passes through a potential obstruction, a detailed graphical study using profile sheets and cross sections may be required.

Right-of-Way Flares

The preferred method to ensure adequate intersection sight distance is to acquire the area(s) within the sight triangles as right of way so the area can be properly managed and kept free of obstructions. These areas are referred to as right-of-way flares.

Right of way Flares should be obtained in order to maintain adequate intersection sight distance at intersections.

4.1.6. Intersection Skew Angle

Ideally, intersecting roadways should meet at or near right angles (90-degrees). This will ensure that the lines-of-sight are optimized for intersection sight distance.

Intersection Skew Angle has been identified by the Department as having substantial importance to the operational and safety performance of a roadway such that special attention should be given to the design decision. GDOT has adopted a 75-degree angle as the minimum skew angle at intersections. A decision to use a skew angle less than 75-degrees shall require a comprehensive study by an engineer and the prior approval of a Design Variance from the Department's Chief Engineer.

In general, where there is a high percentage of truck traffic, a 90-degree intersection should be provided. The closer an intersection angle is to 90-degrees, the greater the safety and operational benefits because:

- exposure time for crossing movements (vehicular and pedestrian) are minimized

- driver discomfort is reduced at right angle versus sharp angle turns (especially for trucks) because drivers will not have to turn their head as much to see the intersection. This is especially true for older drivers who tend to have a decline in head and neck mobility. ¹
- the bodies of larger vehicles, such as ambulances, motor homes, tractor trailers, etc. tend to interfere with the drivers field of view when at skewed intersection. ²
- signing and pavement markings, channelization, and signalization layouts are simplified

When a “T” intersection becomes a four-way intersection due to extension of an existing side street or construction of a driveway opposite the side street, the new facility will usually be built at or very nearly 90-degrees to the mainline. Cross traffic operations are much safer and more efficient if the existing side street leg is at the same angle. The condition is very likely to occur on divided highways where development is concentrated at established median breaks.

The AASHTO *Green Book* acknowledges that sharp curves may be as great a hazard as the acute-angle crossing itself. However, rather than omitting the curves and retaining the acute-angle crossing, the effect of the curves should be mitigated. For example, warning signs for reduction of speed in advance of such curves could be provided. This is especially appropriate for “T” intersections and cross roads with low volumes of through traffic.

As the state of Georgia considers more alternative intersection and interchange control types and with the implementation of the [Intersection Control Evaluation \(ICE\) policy](#), the need to provide policy guidance to ensure the safe and efficient movement of vehicles and pedestrians through these types of interchanges has arisen. The Diverging Diamond Interchange (DDI) also known as the double crossover diamond (DCD) is one alternative interchange design where the intersection skew angle or, more specifically, the crossover angle will differ from that of a basic, general or conventional interchange. The crossover angle is recommended to be as close to and no less than 45 degrees. Documented ongoing research efforts have shown lower crossover angles of 40 degrees or less had the highest number of wrong-way movements, and as a result it is desirable to provide the largest crossing angle while adapting to each site’s unique conditions. Reference the Federal Highway Administration Diverging Diamond Interchange Informational Guide³ for more detailed information.

4.2 Horizontal Alignment

“Horizontal Curve Radius” has been identified as a “controlling criteria” that has substantial importance to the operational and safety performance of a roadway such that special attention should be given to the design decision. Therefore, GDOT adopts the AASHTO Green Book, “A Policy on Geometric Design of Highways and Streets,” and the AASHTO “A

¹ FHWA. Highway Design Handbook for Older Drivers and Pedestrians, 2001. The 2001 version of this publication is available online at <https://www.fhwa.dot.gov/publications/research/safety/humanfac/01103/>

² MBTC FR 1073. Intersection Angle Geometry and the Driver’s Field of View, 1997.

http://ww2.mackblackwell.org/web/research/ALL_RESEARCH_PROJECTS/1000s/1073-gattis/MBTC-1073.pdf

³ U.S. Department of Transportation Federal Highway Administration August 2014 Diverging Diamond Interchange Information Guide is available online at the following site:

https://safety.fhwa.dot.gov/intersection/alter_design/pdf/fhwas14067_ddi_infoguide.pdf

Policy on Design Standards – Interstate System” criteria as the standard for elements of horizontal alignment. A decision to use a horizontal curve radius value that does not meet the minimum controlling criteria defined by AASHTO shall require a comprehensive study by an engineer and the prior approval of a Design Exception (high speed roadways) or Design Variance (low speed roadways) from the Department’s Chief Engineer.

The location and alignment selected for a highway are influenced by factors such as physical controls, environmental considerations, economics, safety, highway classification and design policies. The horizontal alignment cannot be finalized until it is coordinated with the vertical alignment and cross section elements of the roadway.

Horizontal curves should be used for all deflections in a horizontal alignment, with the exception of alignment changes without horizontal curves as discussed in detail in Section **4.2.2. Types of Curves** of this Manual. In special situations, such as roadway reconstruction or widening on existing alignment, practicality will dictate when deflection angles (PI without a curve) may be introduced in lieu of horizontal curvature. Spiral curves are generally not utilized on Georgia roadways.

Refer to the AASHTO *Green Book* Chapter 3, Elements of Design, when determining the radii of horizontal curves and corresponding superelevation (if applicable). Wherever possible, minimum curve radii and maximum superelevation rates should be avoided for any given design speed.

4.2.1. Theoretical and General Considerations

See the Green Book Chapter 3, Section 3.3 “Horizontal Alignment” section for theoretical and general considerations when setting a horizontal alignment.

- In general, the number of short curves should be kept to a minimum.
- Long tangents are needed on two-lane highways such that sufficient passing sight distance is available on as great a percentage of the roadway as possible.
- Sharp curvature should be avoided near the following locations: elevated structures; at or near a crest in grade; at or near a low point in a sag or grade; at or near intersections, transit stops, or points of ingress or egress; and at or near decision points.
- The concepts of stopping sight distance, intersection sight distance, decision sight distance and driver expectancy should be considered during the development of horizontal alignments. If possible, the horizontal alignments of roadways should be free of curvature in and around intersections, interchanges, bridges, railroad crossings, toll plazas, drop lanes and roadside hazards.
- To facilitate pavement drainage, alignments should be laid out such that the 0% cross slope flat points associated with superelevation transitions on either end of a horizontal curve (if applicable) does not correspond to low points in the roadway vertical profile. Superelevation is discussed in this Manual in **Section 4.5**.
- The horizontal alignment should be coordinated carefully with the vertical profile design. This subject is discussed in further detail in this Manual in **Section 4.4**.
- The design speed of successive horizontal curves on ramps can vary as vehicles are often accelerating or decelerating. A common rule to apply to the speed design of ramps is that

the design speed of the first curve of an exit ramp can be assumed to be 10 mph less than the design speed of the mainline. With each successive curve on the exit ramp, the design speed of the curve may be reduced based on computed vehicle deceleration. The process is to be reversed for entrance ramps, i.e., the design speed for curves will successively increase until the design speed of the last curve before the mainline is 10 mph less than that of the mainline.

For additional considerations and guidance in setting horizontal alignments, refer to of the AASHTO *Green Book* Chapter 3, Elements of Design - Horizontal Alignment.

4.2.2. Types of Curves

The following types of curves are discussed in this section:

- circular curves
- compound curves
- reverse curves
- spiral curves
- broken back curves
- curves with small deflection angles
- minimum length of horizontal curve
- alignment changes without horizontal curves

Circular Curves

GDOT typically uses the arc definition of the circular curve. Under this definition, the curve is defined by the degree of curve (D_a), which is the central angle formed when two radial lines at the center of the curve intersect two points on the curve that are 100-ft. apart, measured along the arc of the curve.

$$D_a = 18,000 / (\pi * R)$$

Where: D_a = Degree of Curve (degrees)
 R = Radius of Curve (ft.)

$$L = (100 * I) / D_a$$

Where: L = Length of Curve (ft.)
 D_a = Degree of Curve (degrees)
 I = Total deflection of curve (degrees)

Compound Curves

Compound curves involve two horizontal curves of different radii sharing a common point for their point of tangent (PT) and point of curve (PC), respectively. For open highways, compound curves between connecting tangents should be used only where existing topographic controls make a single simple curve impractical.

Guidance regarding compound curves falls into two categories:

- **Roadways (excluding ramps), one-way or two-way** - The radius of the flatter curve should not exceed the radius of the sharper curve by more than 50% (a ratio of 1.5:1).

- **Ramps** - A ratio as great as 1.75:1 may be used on one-way interchange ramps, where compound curves are more common. Ratios greater than 2.0:1 are strongly discouraged. The compound radii ratio criteria are only applicable when the curve radii decreases from one curve to the next in the direction of travel.

Reverse Curves

Any abrupt reversal in alignment should be avoided. A reversal in alignment can be suitably designed by including a sufficient length of tangent between the two curves to provide adequate superelevation transitions. See **Section 4.4. Combined Horizontal and Vertical Alignments** for additional discussion of superelevation transition lengths.

The tangent distance between reverse curves should be the distance (based on the appropriate gradient or ratio) to rotate from $\frac{2}{3}$ of the full superelevation rate of the first curve to $\frac{2}{3}$ of the full superelevation rate of the second curve. For roadways with design speeds less than or equal to 45 mph, a minimum tangent of 100-ft. should be provided between reverse curves, even if superelevation is not required.

With or without superelevation, extreme physical constraints may dictate the use of a reverse curve with a 0-ft. length tangent (the PT of the first curve and the PC of the second curve are at the same location). In this case, the 0% cross slope point should be placed at the shared PT/PC and use the best possible superelevation transition ratio.

Where it is impractical to provide a tangent length capable of incorporating the superelevation runoff lengths and the tangent run out lengths of both superelevated curves, the 0% cross slope point should be placed at a point derived from the best possible superelevation transition ratio between the two curves (not necessarily the center of the tangent). For an expanded discussion of superelevation refer to **Section 4.4. Combined Horizontal and Vertical Alignments**.

On higher-speed roadways (design speeds greater than or equal to 50 mph); curves that do not require superelevation are so flat that no tangent between the curves is necessary. However, wherever practical, a 150-ft. minimum tangent should be introduced between reverse curves. On higher speed roadways with curves requiring superelevation, a tangent length suitable for accommodating the necessary superelevation transition should be provided (see **Section 4.4. Combined Horizontal and Vertical Alignments**).

For reverse curves on a roadway with a design speed greater than or equal to 50 mph, the use of tangent lengths less than those calculated by AASHTO procedures shall require a comprehensive study by an engineer and the prior approval of a design variance.

Spiral Curves

Spiral curves are generally not utilized on Georgia roadways, except in special cases. For overlay or widening projects, existing spiral curves may remain. For roadways to be re-constructed, existing spiral curves may be replaced with simple curves, unless existing property improvements or other controls make this impractical. Refer to the AASHTO *Green Book* Chapter 3, Elements of Design, for additional information on spiral curves.

Railroads typically utilize spiral curves at the beginning and end of each simple horizontal curve. A project involving a railroad crossing and possibly track relocation may require the use of spiral curves. For additional information related to the design of railroad alignments (including spiral

curves), refer to the American Railway Engineering and Maintenance-of-Way Association (AREMA) Manual for Railway Engineering.

Broken-Back Curves

Successive curves in the same direction that are separated by a short tangent are known as broken-back curves. GDOT defines this short tangent as one with a length less than:

- $15*V$ for design speeds less than 50 mph, or
- $30*V$ for design speeds greater than or equal to 50 mph.

In these equations, V is the design speed in mph.

Broken-back curves are very undesirable from both an operational and an appearance standpoint. While it may not be feasible or practical in some situations to completely eliminate broken-back curves, every effort should be made to avoid this type of alignment if possible by separating, combining, or compounding curves in the same direction.

Curves with Small Deflection Angles

A short horizontal curve with a small deflection angle (less than five degrees) may appear as a kink in the roadway. As a minimum, curves should be at least 100-ft. in length for every one degree of central angle.

Minimum Length of Horizontal Curve

The minimum length of horizontal curve should be in accordance with the following:

$$L = 15*V \quad \text{Where:} \quad \begin{array}{l} L = \text{minimum curve length (ft.)} \\ V = \text{design speed (mph)} \end{array}$$

On high-speed controlled-access facilities that use large-radius curves, the minimum length of horizontal curve should be in accordance with the following:

$$L = 30*V \quad \text{Where:} \quad \begin{array}{l} L = \text{minimum curve length (ft.)} \\ V = \text{design speed (mph)} \end{array}$$

Alignment Changes without Horizontal Curves

There may be instances where existing constraints will make it impractical to utilize horizontal curves which maintain the minimum length criteria specified in the first seven cases cited in **Section 4.2.1. General Considerations**. Right-of-way, cost, or environmental constraints could be prohibitive on widening, reconstruction, maintenance, safety, and 3R projects in both urban and rural settings.

When situations warrant, slight deflection angles may be introduced to (or maintained on) the roadways horizontal alignment. These angles will be very slight so that they do not adversely affect safety or operations. Acceptable angles of deflection will depend on the design speed of the facility.

Table 4.1. lists the maximum angle of horizontal deflection for roadways in Georgia.

Table 4.1. Maximum Horizontal Alignment Deflection without Use of a Curve

Design Speed (MPH)	Maximum Angle of Horizontal Deflection (minutes)
15	120
20	90
25	60
30	45
35	40
40	35
45	30
50	25
55	20
60	18
65	16
70	14
75	12
80	10

The use of horizontal curves is preferable to deflection angles. However, there are cases where small deflections are acceptable. For example, as shown in **Table 4.1**, an existing deflection angle up to 14 minutes (imperceptible to the eye) on an interstate widening project (design speed 70 mph) may be maintained.

At intersections with an all-way stop condition (with no foreseeable signalization) and some form of constraint, there may be a break in the roadway alignment as much as five degrees (at the centerline crossing in the intersection), provided intersection sight distance is maintained in all directions.

4.2.3. Pavement Widening on Curves

On modern highways and streets that feature 12-ft. lanes and high-type alignments, the need for widening on curves has decreased considerably in spite of high speeds. In many cases, degrees of curvature and pavement widths established by policies in this Design Manual preclude the necessity of pavement widening on roadway curves. This is especially true if the alignments are as directional as practical, consistent with the topography, and developed properties and community values are preserved (refer to **Section 4.2.1. General Considerations**). However, for some conditions of speed, curvature, and width, it may still be necessary to widen pavements. Widening should be evaluated at the following locations:

- low speed roadways with near maximum curvature
- ramps
- connecting roadways
- where curves sharper than those specified in this Manual are used

Specific values for pavement widening in curves are shown in **Table 4.2. Pavement Widening on Curves on Two-Lane Roadways**. For additional discussion and widening values, refer to the AASHTO *Green Book*, Chapter 3. Elements of Design – Traveled-Way Widening on Horizontal Curves.

4.2.4. Lane Width Transitions and Shifts

Lane width transitions can occur at several locations including:

- Lane width transitions which are to be developed for curves (see **Section 4.2.3. Pavement Widening on Curves**)
- Connections to existing pavement – such as pavement tapers which occur at the back of a turnout on an existing side road
- Transitions to a wider lane – such as a truck lane or a one-way, one-lane ramp
- Mainline lane shifts in advance of an intersection
- Mainline lane shifts in advance of a typical section change such as the addition of a mainline lane
- Mainline lane shifts in advance of a typical section change such as a change in median width

There are two methods by which an alignment transition or “shift” may be accomplished:

- The first method is to treat the transition or shift as though it were any other required alignment change. With this approach, a transition or shift would be accomplished through the use of a series of reverse curves. Quite often, the use of curve radii which do not require superelevation result in a length of transition greater than that required by providing a taper. Superelevation should be utilized if warranted by normal procedures.
- The second method of accomplishing a transition or “shift” involves the use of tapers. Tapers are acceptable provided the following two conditions exist:

The alignment shift is consistent with the cross slope of the roadway and does not require “shifting” over the top of an existing pavement crown.

The direction of the shift is not counter to the pavement cross-slope (from a superelevation or reverse-crown consideration).

Taper lengths associated with shifts on Georgia roadways should be calculated as:

$$\text{Case 1 – Design Speed } \geq 45 \text{ mph: } L = W * s$$

$$\text{Case 2 – Design Speed } < 45 \text{ mph: } L = \frac{(W * s^2)}{60}$$

Where: L = distance needed to develop widening (ft.)

W = width of lane shift (ft.)

s = design speed (mph)

Note: the Case 1 and Case 2 taper lengths described above are applicable to permanent conditions. For a more detailed discussion on temporary conditions associated with construction, refer to the **Manual on Uniform Traffic Control (MUTCD)** for guidance.

Table 4.2. Pavement Widening on Curves on Two-Lane Roadways

Degree Curve	Radius (ft.)	24-ft. Roadway					22-ft. Roadway					20-ft. Roadway			
		30 (mph)	40 (mph)	50 (mph)	60 (mph)	70 (mph)	30 (mph)	40 (mph)	50 (mph)	60 (mph)	70 (mph)	30 (mph)	40 (mph)	50 (mph)	60 (mph)
1.00	5,729.58	0.0	0.0	0.0	0.0	0.0	0.5	0.5	0.5	1.0	1.0	1.5	1.5	1.5	2.0
2.00	2,864.79	0.0	0.0	0.0	0.5	0.5	1.0	1.0	1.0	1.5	1.5	2.0	2.0	2.0	2.5
3.00	1,909.86	0.0	0.0	0.5	0.5	1.0	1.0	1.0	1.5	1.5	2.0	2.0	2.0	2.5	2.5
4.00	1,432.39	0.0	0.5	0.5	1.0	1.0	1.0	1.5	1.5	2.0	2.0	2.0	2.5	2.5	3.0
5.00	1,145.92	0.5	0.5	1.0	1.0	1.5	1.5	1.5	2.0	2.0	2.0	2.5	2.5	2.5	3.5
6.00	954.93	0.5	1.0	1.0	1.5	1.5	1.5	2.0	2.0	2.5	2.5	3.0	3.0	3.0	3.5
7.00	818.51	0.5	1.0	1.5	1.5	1.5	1.5	2.0	2.5	2.5	2.5	3.0	3.0	3.5	3.5
8.00	716.20	1.0	1.0	1.5	1.5	1.5	2.0	2.0	2.5	2.5	2.5	3.0	3.0	3.5	3.5
9.00	636.62	1.0	1.5	2.0	2.0	2.0	2.0	2.5	3.0	2.5	2.5	3.0	3.0	3.5	4.0
10.18	562.64	1.0	1.5	2.0	2.0	2.0	2.0	2.5	3.0	2.5	2.5	3.0	3.0	3.5	4.0
12.24	488.04	1.0	2.0	2.0	2.0	2.0	2.5	3.0	3.0	2.5	2.5	3.0	3.0	3.5	4.0
15.30	374.48	2.0	2.0	2.0	2.0	2.0	3.0	3.0	3.0	2.5	2.5	3.0	3.0	3.5	4.0
19.35	296.10	2.5	2.0	2.0	2.0	2.0	3.5	3.0	3.0	2.5	2.5	3.0	3.0	3.5	4.0
22.42	255.59	3.0	2.0	2.0	2.0	2.0	4.0	3.0	3.0	2.5	2.5	3.0	3.0	3.5	4.0
26.44	216.69	3.5	2.0	2.0	2.0	2.0	4.5	3.0	3.0	2.5	2.5	3.0	3.0	3.5	4.0

Notes:

1. Values for widening (ft.) for two-lane roadways - one-way or two-way traffic
2. Disregard values less than 2.0-ft. (above heavy line and not within highlighted area) for two-lane (one-way or two-way traffic) pavements
3. For three-lane and four-lane undivided roadways multiply values by 1.5 and 2.0, respectively and round to the nearest 0.5-ft. If values are less than 2.0-ft., disregard
4. Pavement widening is intended for utilization where truck traffic is significant and the increase in pavement width is to be 2.0-ft. or greater
5. Locations for pavement widening shall be shown in the construction plans or specified by the Engineer
6. Pavement widening to occur along the inside of the normal curve. Additional width is to be shared equally by all lanes.

4.2.5. Transition in Number of Lanes

Instances where the number of lanes on a roadway is transitioning fall into two categories – lane additions and lane drops. Lane drops induce a merge situation. Adequate distance for drivers to perform the merge maneuver should thus be provided. Lane additions that do not involve a shift of the mainline lanes may be accomplished in a much shorter distance.

Lane Drops

Lane drops can occur in many situations on all types of roadways, such as:

- mainline lane drop due to traffic drop off
- mainline lane drop to meet lane balance requirements (limited access)
- mainline lane drop due to transition to non-widened section, etc.
- end of auxiliary lane
- end of collector-distributor (cd) system
- end of climbing lane
- ramp merges on limited access facilities

With three exceptions, lane drops (or merges) for the situations listed above should be designed based on the minimum convergence tapers provided in **Section 4.2.4. Lane Width Transitions and Shifts**.

Exception 1 – For lane drops and merges on high-speed Limited Access facilities, where design year mainline peak hour traffic rates exceed 1,550 vehicles per lane (LOS C), the convergence ratio should be:

$$L = 2 * W * s$$

Where: L = distance needed to develop widening (ft.)
 W = width of lane shift (ft.)
 s = design speed (mph)

Exception 2 – Certain situations require the use of horizontal curves and possibly superelevation in association with lane reductions. An example of this would be tie-ins being constructed on projects between a proposed four-lane section (with 44-ft. median) and a two-lane existing section. In these situations, a lane should first be dropped using the taper rates specified in **Section 4.2.4. Lane Width Transitions and Shifts**, while still on the four-lane section (in advance of the crossover). Once the lane reduction has been attained, the tie-in to the two-lane section should be accomplished with a tie-in using AASHTO horizontal curves and superelevation rates appropriate for the design speed of the facility. If possible, the curves associated with the tie-in should be no sharper than 1 degree.

Exception 3 – If a ramp merge occurs on a significant upgrade, the speed differential of a truck or bus merging into traffic should be evaluated. In general, if the mainline grades exceed 3% (upgrade in merge), the convergence ratio should be:

$$L = 2 * W * s$$

Where: L = distance needed to develop widening (ft.)

W = width of lane shift (ft.)

s = design speed (mph)

General Rules on Lane Drops

- lane drops on limited access facilities should occur at exits
- lane drops on limited access facilities should occur on the outside lanes
- upon departing an intersection, a lane (to be dropped) should be maintained for a minimum of 800-ft. from the intersection before initiating the lane drop
- tapers associated with multiple, successive lane drops on the mainline should be separated by a minimum 1,000-ft. tangent section

Lane Additions

Lane additions that are not accompanied by a mainline alignment shift can be performed over a relatively short distance. A minimum 15:1 expansion taper rate should be provided. However, when spatial constraints exist, expansion tapers may be as low as 5:1 (urban) and 8.33:1 (rural).

Required lane addition taper lengths associated with median breaks and intersections can utilize taper rates less than those pertaining to through lanes. GDOT *Construction Standards and Details*, Construction Details M-3A and M-3B depicts turn lane taper lengths associated with Type A, B and C medians.

Table 4.3. Turn Lane Transition Tapers summarizes taper length and taper ratio requirements as they pertain to the addition of left-turn and right-turn lanes in Georgia. The designer should attempt to meet the values found in this table. However, if constraints such as right-of-way, environmental impacts, utility conflicts and/or driveway/access issues exist, the minimum values may be utilized.

When a lane addition occurs due to the generation of a center lane or a passing lane (i.e., when a two-lane road is to be widened to a three-lane section) the transition tapers must follow the guidelines discussed in **Section 4.2.4. Lane Width Transitions and Shifts**.

Table 4.3. Turn Lane Transition Tapers

Design Speed (mph)	Urban or Rural	Median Width (ft.)	Transition Width, W (ft.)	Minimum				Desirable				
				Left Turn		Right Turn		Left Turn		Right Turn		
				Taper Ratio	Taper Length (ft.)	Taper Ratio	Taper Length (ft.)	Taper Ratio	Taper Length (ft.)	Taper Ratio	Taper Length (ft.)	
Type A Median												
≥ 45	Rural	40	12	8.33:1	100	8.33:1	100	15:1	180	15:1	180	
≥ 45	Rural	44	12	8.33:1	100	8.33:1	100	15:1	180	15:1	180	
≥ 45	Rural	64	12	8.33:1	100	8.33:1	100	15:1	180	15:1	180	
Type B Median												
≥ 45	Rural	32	4	15:1	60	8.33:1	100	15:1	60	15:1	180	
≥ 45	Rural	44	16	15:1	240	8.33:1	100	15:1	240	15:1	180	
≥ 45	Rural	64	26	15:1	390	8.33:1	100	15:1	390	15:1	180	
Type C Median												

< 45	Urban*	20	12	5:1	60	8.33:1	100	15:1	180	15:1	180
Flush Median											
≥ 45	Rural	14	14	8.33:1	116	8.33:1	100	15:1	210	15:1	180
≥ 45	Rural	Varies	14	8.33:1	116	8.33:1	100	15:1	210	15:1	180
* An urban section with a Type C Median can be used for design speeds of 45 mph											

If the widening will be asymmetric or will occur only to one side, the transition width (W) is the width of the additional lane. If the widening will be symmetric, i.e., both directions of travel bifurcate symmetrically to create a center lane, then the transition width (W) can be assumed to be ½ of the width of the additional lane. For instance, if a 14-ft. center turn lane was being generated symmetrically on a 55 mph two-lane roadway, the taper length would be:

$$L = \left(\frac{14.0}{2}\right) * 55 = 385.0 \text{ ft.}$$

Turn Lanes in an Intersection or Median

Refer to **Table 4.3.** for a general guideline on minimum and desirable turn lane transition taper values.

A summary of other special cases for transition tapers is included in **Table 4.4. Miscellaneous Transition Tapers.**

Table 4.4. Miscellaneous Transition Tapers

Location	Design Speed (mph)	Transition Width, W (ft.)	Minimum Taper (ft.)
Driveways	< 45	12	50
Driveways	≥ 45	12	100
Parallel Ramps on Limited Access Facilities – Entrance	Varies	12	250
Parallel Ramps on Limited Access Facilities – Exit	Varies	12	250

4.3 Vertical Alignment

“Maximum Grade” and “Vertical Clearance” have been identified as “controlling criteria” that have substantial importance to the operational and safety performance of a roadway such that special attention should be given to the design decision. Therefore, GDOT adopts the AASHTO Green Book, “A Policy on Geometric Design of Highways and Streets,” and the AASHTO “A Policy on Design Standards – Interstate System” criteria as the standard for elements of maximum grade and vertical clearance. A decision to use a value that does not meet the minimum controlling criteria defined by AASHTO shall require a comprehensive study by an engineer and the prior approval of a Design Exception (high speed roadways) or Design Variance (low speed roadways) from the Department’s Chief Engineer.

GDOT uses design controls for crest vertical curves based on sight distance. The AASHTO *Green Book* Chapter 3, Elements of Design, provides additional discussion on rates of vertical curvature (K). Maximum allowable vertical grades are dependent on the chapters:

- Chapter 5. Local Roads and Streets
- Chapter 6. Collector Roads and Streets
- Chapter 7. Rural and Urban Arterials
- Chapter 8. Freeways

GDOT typically uses symmetrical parabolic vertical curves at changes in grade. Exceptions to this include spot locations such as alignment breaks near intersections and overlay transitions where vertical grade breaks can be accomplished without the use of vertical curves. The maximum grade break (%) varies based on the design speed of the facility.

4.3.1. General Considerations for Vertical Alignments

The following are general considerations for vertical alignments:

- Maximizing sight distances should be a primary consideration when establishing vertical alignment.
- Long, gentle vertical curves should be used wherever possible and appropriate.
- “Roller coaster” or “hidden dip” profiles should be avoided by using gradual grades made possible by heavier cuts and fills or by introducing some horizontal curvature in conjunction with vertical curvature. The “roller coaster” may be justified in the interest of economy and may be acceptable in low-speed conditions, but is aesthetically undesirable.
- A single long vertical curve is preferred over "broken-back" grade lines (two crest or two sag vertical curves separated by a short tangent).
- Use a smooth grade line with gradual changes, consistent with the type of highway and character of terrain, rather than a line with numerous breaks and short lengths of tangent grades.
- On a long ascending grade, it is preferable to place the steepest grade at the bottom and flatten the grade near the top.
- Moderate grades should be maintained through intersections to facilitate turning movements. Grades should not exceed 6%, and 3% maximum is preferred.
- Sag vertical curves should be avoided in cuts as roadway flooding or ponding conditions may occur at these locations should the drainage system become clogged or overburdened.
- Vertical grades should be coordinated with required acceleration and deceleration areas, wherever possible. For instance, at an interchange, it is preferable for the crossing roadway to go over the limited access facility. That way, vehicles are on an upgrade as they decelerate towards a stop condition and are on a downgrade as they are entering the limited access facility.
- As much as possible, the vertical alignment should be closely coordinated with the natural topography, available right of way, utilities, roadside development, and existing drainage patterns.
- Vertical alignments should be properly coordinated with environmental constraints (e.g., encroachment into wetlands).

- When a vertical curve takes place partly or wholly in a horizontal curve, the vertical curvature should be coordinated with the horizontal curvature. **See Section 4.4. Combined Horizontal and Vertical Alignments.**
- When one roadway is in a tangent section and an intersecting roadway has a continuous vertical grade through an intersection, consideration should be given to rotating the pavement cross slope on the tangent roadway to a reverse crown to better match the profile of the intersecting roadway. Standard superelevation transition rates would apply.

Additional considerations for setting vertical alignments are detailed in the AASHTO *Green Book* Chapter 3, Elements of Design.

Factors That Influence Roadway Grades

There are many factors that influence roadway grades:

- topography and earthwork
- control points at the beginning and end of the project
- vertical clearances for drainage structures
- intersecting railroads
- applicable glide slopes for roadways near airports
- intersecting roads and streets
- driveway tie-ins
- existing bridges to remain
- vertical clearances at grade separations
- vertical clearances for high water and flood water
- proposed new bridges
- driver expectancy at intersections
- crosswalks at intersections

4.3.2. Maximum Vertical Grades

The grades selected for vertical alignments should be as flat as practical, and should not exceed the values listed in **Table 4.5 Maximum Vertical Grades**. Maximum values vary based on types of terrain, facility classification, and design speed. The maximum design grade should be used infrequently; in most cases, grades should be less than the maximum design grade. In **Table 4.5. Maximum Vertical Grades**, industrial roadways are defined as local and collector streets with significant (15% or more) truck traffic. Exceptions to the maximum vertical grades can be found in the AASHTO Green Book applicable sections.

Maximum values in **Table 4.5.** may be reduced when upgrades cause a speed reduction greater than or equal to 10 mph. For streets and highways requiring long upgrades the maximum grade should be reduced so that the speed reduction of slow-moving vehicles (i.e., trucks and buses) is not greater than or equal to 10 mph. Where reduction of grade is not practical, climbing lanes

should be provided to meet these speed reduction limitations. **If the maximum grade cannot be reduced and climbing lanes cannot be provided, a comprehensive study by an engineer and the prior approval of a design exception (high speed roadways) or design variance (low speed roadways) is required.**

Climbing lanes, speed reductions on upgrades and the critical lengths of grade associated with speed reductions are concepts that are discussed in detail in the AASHTO *Green Book* Chapter 3, Elements of Design. These concepts should be considered and appropriate provisions should be incorporated into any facility in which vertical grades will cause a significant (10 mph or more) reduction in the speed of a slow-moving vehicle.

ADA/PROWAG Requirements and Vertical Alignment – where sidewalks and/or crosswalks are located along or are crossing the roadway:

Sidewalks

Section R302.5 Grade of the PROWAG states, “the grade of pedestrian access routes shall not exceed the general grade established for the adjacent street or roadway.” Nevertheless, consideration should be given to limiting roadway vertical grades to no more than 5%. In many cases this will not be practical.

In urban and suburban situations, where the roadway typical section includes curb and gutter, the sidewalk is normally located behind (and adjacent to or offset from) the roadway. Since topography and practicality can often dictate that many curb and gutter roadways have longitudinal slopes in excess of 5%, the running (i.e., longitudinal) slope of sidewalks often exceed 5%.

Notwithstanding, GDOT recognizes the merit in attempting to limit sidewalk longitudinal slopes wherever possible. With regard to sidewalks, longitudinal slopes and mainline roadway profiles, GDOT offers the following approach:

- On new alignment urban roadways, roadway grades should be limited to 5%, wherever practical. Applicable overriding constraints include environmental, right-of-way, cost, topography, and context-sensitive design areas. The maximum values in **Table 4.5** may be used, if necessary.
- When an existing urban roadway is to be reconstructed, the practicality of vertical reconstruction by limiting proposed grades to 5% should be evaluated. If this approach is found to be impractical, the maximum values in **Table 4.5** may be used.

In either a new location or existing reconstruction situations where roadway grades exceed 5%, consider providing pedestrian signage and connections to an alternate pedestrian route which has running slopes no greater than 5%.

Crosswalks

Section R302.6 Cross Slope (i.e. grade of roadway) of the PROWAG states that, “Where pedestrian access routes are contained within pedestrian street crossings without yield or stop control, the cross slope of the pedestrian access route [i.e., crosswalk] shall be 5 percent maximum.” This applies to signalized intersections and other conditions where vehicles can proceed through the intersection without slowing or stopping. For yield and for stop control the maximum cross slope is 2%.

Section 302.5.1 Pedestrian Street Crossings of the PROWAG states that, “Where pedestrian access routes are contained within pedestrian street crossings, the grade of the pedestrian access shall be 5 percent maximum.” (i.e. cross slope of roadway)

A decision to select a value or retain an existing condition that does not meet these criteria, as defined in the PROWAG, shall require a comprehensive study by an engineer and the prior approval of a Design Variance from the GDOT Chief Engineer. Refer to **Section 9.5.1 Pedestrian Accommodation Design** of this manual for more information.

4.3.3. Minimum Vertical Grades

Minimum vertical grades are typically used to facilitate roadway drainage. This is especially true of curbed roadway sections where drainage or gutter spread is a consideration.

Uncurbed Pavements

For projects involving uncurbed pavements, longitudinal grades may be flat (0%) in areas where appropriate cross slopes are provided. In areas of superelevation transitions and/or flat cross slopes on those projects, minimum vertical grades should be consistent with those listed in **Table 4.6. Minimum Vertical Grades for Roadways where Drainage Spread is a Consideration.** However, there are situations with uncurbed pavements where it is prudent that consideration be given to maintaining minimum vertical grades - similar to those for curbed roadway sections. These situations include:

- a new location rural section
- roadways with high truck percentages that experience appreciable pavement rutting
- current rural roadways in urban, suburban or developing areas that have a realistic chance of being converted to a curb and gutter sometime in the foreseeable future
- areas containing superelevation transitions and/or flat cross slope areas
- interstate or other high speed facilities

Table 4.5. Maximum Vertical Grades

Type of Terrain	Maximum Grade (%) for Specified Design Speed (mph)														
	15	20	25	30	35	40	45	50	55	60	65	70	75	80	
Industrial Roadways															
Level	-	-	4	4	4	4	3	3	3	3	-	-	-	-	
Rolling	-	-	5	5	5	5	4	4	4	4	-	-	-	-	
Mountainous	-	-	6	6	6	6	5	5	5	5	-	-	-	-	
Local Rural Roads															
Level	9	8	7	7	7	7	7	6	6	5	-	-	-	-	
Rolling	12	11	11	10	10	10	9	8	7	6	-	-	-	-	
Mountainous	17	16	15	14	13	13	12	10	10	-	-	-	-	-	
Local Urban Streets															
Level	12	11	11	10	10	9	9	8	8	-	-	-	-	-	
Rolling	14	13	12	11	11	10	10	9	-	-	-	-	-	-	
Mountainous	17	16	15	14	13	12	11	-	-	-	-	-	-	-	
Rural Collectors															
Level	-	7	7	7	7	7	7	6	6	5	-	-	-	-	
Rolling	-	10	10	9	9	8	8	7	7	6	-	-	-	-	
Mountainous	-	12	11	10	10	10	10	9	9	8	-	-	-	-	
Urban Collectors															
Level	-	9	9	9	9	9	8	7	7	6	-	-	-	-	
Rolling	-	12	12	11	10	10	9	8	8	7	-	-	-	-	
Mountainous	-	14	13	12	12	12	11	10	10	9	-	-	-	-	
Rural Arterials															
Level	-	5	5	5	5	5	5	4	4	3	3	3	3	3	
Rolling	-	8	8	7	7	6	6	5	5	4	4	4	4	4	
Mountainous	-	10	9	8	8	8	7	7	6	6	5	5	5	5	
Urban Arterials															
Level	-	8	7	7	7	7	6	6	5	5	-	-	-	-	
Rolling	-	10	10	9	8	8	7	7	6	6	-	-	-	-	
Mountainous	-	13	12	11	10	10	9	9	8	8	-	-	-	-	
Rural and Urban Freeways (Limited Access Facilities)															
Level	-	-	-	-	-	-	-	4	4	3	3	3	3	3	
Rolling	-	-	-	-	-	-	-	5	5	4	4	4	4	4	
Mountainous	-	-	-	-	-	-	-	6	6	6	5	5	-	-	

Curbed Pavements

For curbed pavements, minimum longitudinal grades are controlled by the values in **Table 4.6**. This includes roadways with concrete median barriers or side barriers, V-gutter and those roadways adjacent to walls. These values will generally ensure that roadway “spread” is not excessive and

can be contained within acceptable ranges by a minimum (reasonable) number of roadway drainage catch basins. The minimum values in **Table 4.6** should be used only under extreme conditions.

Table 4.6. Minimum Vertical Grades for Roadways where Drainage Spread is a Consideration

Type of Facility	Minimum Grade (%)	
	Desirable	Minimum
Industrial Roadways with Curb and Gutter	0.30	0.20
Local Urban Streets with Curb and Gutter	0.30	0.20
Urban Collectors with Curb and Gutter	0.50	0.30
Urban Arterials with Curb and Gutter	0.50	0.30
Urban Freeways or Limited Access Facilities	0.50	0.30

4.3.4. Vertical Curves

In almost all cases, changes in grade should be connected by a parabolic curve (the vertical offset being proportional to the square of the horizontal distance). Vertical curves are required when the algebraic difference of intersecting grades exceeds a minimum threshold (refer to **Section 4.3.5. Maximum Change in Vertical Grade without Using Vertical Curves**).

Refer to the AASHTO *Green Book* Chapter 3, Elements of Design – Vertical Curves, for considerations that must be made for vertical curves.

General Considerations

Vertical alignment has significant effect on roadway drainage. Special consideration should be given to the following:

- Curbed roadways should have a minimum grade of not less than the values specified in **Section 4.3.3. Minimum Vertical Grades** in order to avoid excessive gutter spread. This includes roadways with concrete median barriers or side barriers, and V-gutter.
- Non-curbed roadways should maintain a minimum grade consistent with the directives of **Section 4.2.3. Pavement Widening on Curves** and **Section 4.3.3. Minimum Vertical Grades**
- For drainage purposes, the K value should not exceed 167 for curbed roadways (crest or sag verticals). In cases where design speeds are higher than 65 mph, this criteria does not apply.
- For curbed roadways in sag vertical curves with low points, a minimum grade of 0.30% should be provided within 50-ft. of the low point. This corresponds to a K value of 167.
- The minimum K values as defined by AASHTO are based on the assumption that there are significant tangent sections on either side of the vertical curve. Therefore, when using compound or unsymmetrical vertical curves, sight distances should be checked graphically to ensure that adequate sight distance is provided. Additional information can be found in the National Cooperative Highway Research Program (NCHRP) Report 504 – Design Speed, Operating, Speed, and Posted Speed Practices.

In establishing the vertical alignment, sound engineering practice should be used to strike a reasonable balance between excavation (cut) and embankment (fill). Other overriding factors must also be considered, including:

- maintenance of traffic
- environmental impacts
- right-of-way impacts
- pedestrian (PROWAG) requirements
- safety considerations
- sight distance considerations (all types)
- drainage considerations
- high water considerations
- ability to tie the roadway profile into side roads, driveways and at grade railroad crossings.
- drivability and driver expectancy

4.3.5. Maximum Change in Vertical Grade without Using Vertical Curves

GDOT typically uses vertical curves for changes in vertical grades. However, there are situations where it is either impractical or impossible to utilize a vertical curve. Such situations include:

- temporary vertical tie-ins
- profile tie-ins such as overlay transitions
- avoidance and/or minimization of an environmental impact
- point profiles in overlay and widening sections
- profile reconstruction near fixed objects such as bridges and approach slabs

Table 4.7. lists the maximum vertical grade changes that do not require a vertical curve. Note that these values change per design speed. Grade breaks should only be used when necessary (vertical curves should be used, wherever practical). If two or more of these vertical grade breaks are utilized in succession (i.e., a point profile), the cumulative effect of these grade breaks in the profile shall be evaluated for stopping sight distance and it shall be verified that typical stopping sight distance is always provided. If the cumulative effect of a series of vertical grade breaks violates stopping sight distance criteria, the values in **Table 4.7.** may need to be reduced.

Table 4.7. Maximum Change in Grade that Does Not Require a Vertical Curve

	Design Speed (mph)										
	20	25	30	35	40	45	50	55	60	65	70
Maximum Change in Grade (%)	1.20	1.10	1.00	0.90	0.80	0.70	0.60	0.50	0.40	0.30	0.20

4.3.6. Vertical Grade Changes at Intersections

If it is impractical to match the elevation of an intersecting road, the crossroad should be reconstructed for a suitable distance using adequate vertical geometry to make the grade adjustment. In general, a 2% maximum tangent grade break is allowed at the edges of signalized intersections to allow vehicles on the crossroads to pass through an intersection on a green signal safely without significantly adjusting their speed. A 4% maximum grade break is allowed in the center of an intersection corresponding to the 4% crown breakover associated with a crossing road.

For the edges of unsignalized or stop condition intersections, a maximum tangent grade break of 4% may be employed.

4.3.7. Minimum Profile Elevation Above High Water

One major factor in establishing a vertical profile for either a roadway or a bridge is clearance over high water or a design flood. For roadways, this is important for two reasons:

- **Pavement Protection** - A major factor in a roadway's durability is minimizing the amount of moisture in the base and pavement. Keeping the roadway base as dry as possible will help prevent or minimize pavement deterioration.
- **Safety** - A roadway with a profile set above the design high water will keep water from overtopping the roadway. Overtopped roadways are a hazard to moving vehicles and can effectively shut down a facility when they are needed most, i.e., a hurricane evacuation route.

For bridges, prescribed low-chord clearances must be maintained to protect the bridge superstructure from unanticipated lateral forces associated with high-velocity flood waters.

GDOT Drainage Design Manual Table 8.2 summarizes the required high water clearances for culverts and [GDOT Drainage Manual Section 12.1.1](#) summarizes the required high water clearances for bridges in Georgia. A vertical profile that satisfies the worst-case situation for either clearance or overtopping shall be established.

Refer to the most current version of the GDOT *Manual on Drainage Design for Highways* (also referred to as the *Drainage Manual*), which may be downloaded from the GDOT Repository for Online Access to Documentation and Standards (R.O.A.D.S.). For roadways, designers should be familiar with the concept of culvert hydraulics and be aware that head losses associated with culverts will generally produce a headwater greater than the design flood elevation of the natural conditions. A vertical profile that provides the prescribed clearances over either the headwater of the natural conditions or the headwater created by a culvert, whichever is greater, shall be developed.

For bridges, designers should be familiar with the concept of riverine hydraulics and coordinate the bridge profile with the results of the bridge hydraulic study. As bridges will tend to generate backwater, a vertical profile that provides the prescribed clearances over the backwater created by the bridge or other nearby influencing structures shall be established. For additional information on Bridge Hydraulic guidelines, please refer to the *GDOT Drainage Manual*.

4.3.8. Reporting Changes in Vertical Clearances

The GDOT Office of Maintenance (Maintenance Office) has the responsibility of providing the Office of Permits and Enforcement with the height limitation of structures. The Bridge Maintenance Office and the Office of Permits & Enforcement have the responsibility of approving the proposed routing on state routes for vehicle movements which are over the legal vertical clearance.

It is extremely important for these offices to be kept informed of any change in vertical clearance as soon as possible after the change occurs. Persons (Area Engineer, Project Engineer) directly involved with vertical clearance revisions to any structure on a state route shall immediately notify:

- **The GDOT Maintenance Office** - Such a report should be made by telephone to the Routing Engineer at (404) 656-5287 or to the Assistant State Maintenance Engineer, Bridges. The Maintenance Office will handle the reporting of the above changes to the Office of Permits & Enforcement.
- **The GDOT Bridge Maintenance & Inventory Office** - This office should be notified of any changes in vertical clearances on the state system within 24 hours.

In cases where the actual measured minimum vertical clearance must be revised, the person directly involved with the revision (Area Engineer, Project Engineer) shall advise the District Maintenance Office of the actual measured minimum vertical clearances on his/her specific construction project(s). The revised information should then be reported to the Bridge Inventory Office, and this information will be directed to local Bridge Inspection personnel, such that the revisions to the Bridge Information System may be verified at a later date. The Bridge Inventory Office in Atlanta will initiate revisions to the system with notification to units requiring the revised information.

The actual measured minimum vertical clearance should be recorded at both edges of the pavement, the crown point (if present) and at the edges of paved shoulders (if present). In addition, measurements at any other restricting locations caused by the geometrics of the overhead structure or roadway should be recorded. Special attention should be paid to the effects of reconstruction at a restrictive location. For example, to resurface beneath a posted clearance without insuring a correction in posting misinforms the traveling public and thus creates a possible hazardous condition.

4.4 Combined Horizontal and Vertical Alignments

Horizontal and vertical alignments are permanent design elements that warrant thorough study. Horizontal and vertical alignments should not be designed independently, but should complement each other. Poorly designed combinations can negate the benefits and aggravate the deficiencies of each. A well-designed combination, in which horizontal and vertical alignments work in concert, increases highway usefulness and safety, encourages uniform speed, and improves appearance.

4.4.1. Aesthetic Considerations

Coordination of the horizontal and vertical alignment can result in a highway that is visually pleasing. This can be achieved in several ways:

- A sharp horizontal curve should not be introduced at or near the low point of a sag vertical curve, which produces a distorted appearance.
- There should be a balance between curvature and grades. The use of steep grades to achieve long tangents and flat curves, or the use of excessive curvature to achieve flat grades, are considered poor design. A logical design is a compromise between the two conditions. Wherever feasible the roadway should “roll with” rather than “buck” the terrain.
- If possible, every effort should be made to line up points of vertical intersection (PVI's) with horizontal points of intersections (PI's) and to maintain consistency between the horizontal and vertical curve lengths. Vertical curvature superimposed on the horizontal curvature generally results in a more visually pleasing facility. Successive changes in profile not in combination with horizontal curvature may result in a series of dips not visible to the driver. If PVI's and PI's cannot be made to coincide, the horizontal curvature should “lead” the vertical curve and the horizontal curve should be slightly longer than the vertical curve in both directions.
- A balanced design which provides horizontal and vertical alignments in the middle range of values is preferable to allowing either horizontal or vertical to become extreme in order to optimize the other.
- Design the alignment to enhance attractive scenic views of the natural and manmade environment, such as rivers, rock formations, parks, and outstanding buildings.
- In residential areas, wherever possible, design the alignment to minimize nuisance factors to the neighborhood. Generally, a depressed facility makes a highway less visible and less noisy to adjacent residents. Minor horizontal adjustments can sometimes be made to increase the buffer zone between the highway and clusters of homes.
- Refer to the GDOT *Context-Sensitive Design Online Manual*, for additional information.

4.4.2. Safety Considerations

The superimposed effect of horizontal and vertical alignments can influence both sight distance and driver expectancy – which translate directly into safety. As safety should be the designer's primary consideration, the following guidelines are presented:

- Sharp horizontal curves should not be introduced at or near the top of a pronounced vertical curve, since the driver cannot perceive the horizontal change in alignment, especially at night.
- Sharp horizontal curves should not be introduced at or near the low point of a sag vertical curve, since vehicles, particularly trucks, are traveling faster at the bottom of grades.
- Both horizontal and vertical curvature should be as flat as possible at intersections where vehicles have to decelerate, stop, or accelerate.
- To maintain proper pavement drainage, design vertical and horizontal curves so that the flat profile of a vertical curve will not be located near the flat cross slope of the superelevation transition. As a general rule, pavement cross slope should be at least 1.0% near vertical curve sag points and longitudinal roadway grades should be at least 0.30% at locations where the pavement cross slope is flat (0%), for instance at superelevation transitions.
- On two-lane roadways, the need for safe passing sections (at frequent intervals and for an appreciable percentage of the length of the roadway) often supersedes the general desirability for combination of horizontal and vertical alignment. The Designer should strive to implement long tangent sections to secure sufficient passing sight distance.
- It is generally poor practice to place the superelevation rotation point at a different point than the profile grade line.
- Particular attention shall be paid to all forms of sight distance when horizontal and vertical alignments are superimposed on each other. The combination of horizontal and vertical curvature can sometimes result in effectively less sight distance than the individual effect of either horizontal or vertical curvature.

4.4.3. Divided Highways

A well designed roadway will incorporate a litany of considerations including safety, economy, and aesthetics, etc. When terrain is hilly, mountainous or undulating, the profile of the roadway should generally follow the contours of the land (barring overriding considerations). On divided highways and rural interstates, the Designer should recognize where terrain dictates, separate horizontal alignments and vertical profiles can be utilized for opposing traffic.

Independent Profiles and Increasing Median Width

On state and federal divided highways, an increase in the width of the median and the use of independent alignments to derive the design and operational advantages of one-way roadways should be considered. Where right of way is available, a superior design, without significant additional costs, can result from the use of independent alignments and profiles. Bifurcated medians are especially effective where the general fall of the terrain is significant and perpendicular to the roadway.

Increasing the width of the median and/or bifurcating the roadway should be considered in the following situations:

- Where right of way is available and where the general fall of the terrain is significant and perpendicular to the roadway

- In isolated areas on rural reconstruction projects where the height of vertical reconstruction is significant. This will facilitate efficiency and ease conflicts during an intermediate stage of construction. As a general rule of thumb, standard 44-ft. median width can be maintained with independent profiles until the difference in elevations in opposing PGL's is approximately 5-ft. Consideration should be given to increasing the median width (beyond 44-ft.) a minimum of 2-ft. for every 1-ft. of vertical profile reconstruction greater than 5-ft. Obviously, increasing the median width will result in greater right of way impacts. However, in many instances, minor right of way impacts - especially in rural areas where it is plentiful – are ultimately less costly than significant vertical reconstructions that require the contractor to utilize earth stabilization techniques or sheet pile to construct.
- At intersections to eliminate breakovers.

4.5 Superelevation

When a vehicle travels around a horizontal curve, it is forced radially outward by centrifugal force. When this force becomes too great for a given design speed, the roadway is “superelevated” to counter it. Five methods of counteracting centrifugal forces through curves are discussed in the AASHTO *Green Book* Chapter 3, Elements of Design.

4.5.1. Superelevation Rate

“Superelevation Rate” has been identified as a "controlling criteria" that has substantial importance to the operational and safety performance of a roadway such that special attention should be given to the design decision. Therefore, GDOT adopts the Superelevation rates shown in table 4.8 as the standard for superelevation rates in Georgia. The FHWA has stated that a Design Exception is required if the State's superelevation rate cannot be met. Therefore, a decision to use a Superelevation rate that does not meet the maximum Superelevation Rate shown in Table 4.8 shall require a comprehensive study by an engineer and the prior approval of a Design Exception (high speed roadways) or Design Variance (low speed roadways) from the Department's Chief Engineer.

Horizontal alignments are composed of tangent sections connected by arcs of circular curves (GDOT does not normally use spiral curves). Vehicles traveling in a circular path counter the centrifugal force that would cause them to leave the road through a combination of two factors: lateral friction between the vehicle's tires and the road, and superelevation.

The maximum rates of superelevation used on highways are controlled by four factors:

- Climatic conditions (i.e., frequency and amount of snow and ice)
- Terrain conditions (i.e., flat, rolling, or mountainous)
- Type of area (i.e., rural or urban)
- Frequency of very slow-moving vehicles whose operation might be affected by high superelevation rates

Superelevation requirements for maximum superelevation rates (0.04 to 0.12-ft./ft.) for various design speeds (15 mph to 80 mph) are provided in the AASHTO *Green Book* Chapter 3, Elements

of Design – Design Superelevation Tables section. GDOT has designated the values in **Table 4.8.** as the maximum values (e_{max}) for use on Georgia roadways.

Table 4.8. Maximum Superelevation Rates

Setting	Maximum Superelevation Rates (e_{max}) ⁽¹⁾
Urban (Curb and Gutter) Roads (DS ≤ 45mph)	4%
Suburban / Developing Areas (2)	6%
Rural (Non Curb and Gutter) Paved Roads Unpaved Roads	6% or 8% Reverse Crown
Interstates, Expressways, L/A Facilities Rural Urban	8% 6%
System-to-System Ramps Rural Urban	8% 6%
Exit-Entrance Ramps	8%
Free Flowing Loop Ramps	10%
Long Ramps with STOP	8%
<p>(1) The maximum allowed values (e_{max}) for usage on Georgia roadways, as designated by GDOT.</p> <p>(2) A maximum rate of superelevation of 6% should be used where (for example) traffic congestion or extensive development acts to restrict operating speeds on a rural roadway,</p> <p>In general, GDOT does not require superelevation on low-speed urban roadways or roadways with a design speed of 25 mph or less</p>	

It is important for designers to realize that the minimum curve radii and maximum superelevation rates depicted in the AASHTO *Green Book* are extremes and should be avoided wherever possible.

The e_{max} values presented in **Table 4.8.** requires the use of the more moderate design value ranges for curvature and superelevation. In certain situations, such as those described below, the e_{max} values in **Table 4.8.** may require further reduction:

- Wherever practical, consideration should be given to maximizing curve radii and minimizing superelevation rates on curves which include bridges. This is due to the increased potential for icing. Where constraints do not exist, an e_{max} of 4% should be utilized.
- Wherever possible, the maximum superelevation rates on roadways within an intersection should be limited to 4% (2% for urban areas with crosswalks). Wherever possible and when applicable in intersections, superelevation cross slopes of one roadway should be coordinated with the mainline profile grade of the intersecting roadway.

4.5.2. Sharpest Curve without Superelevation

Although superelevation is advantageous for high-speed traffic operations, various factors combine to make its use impractical in many built-up areas. Such factors include:

- wide pavement areas
- need to meet grade of adjacent property
- surface drainage considerations
- frequency of cross streets, alleys and driveways
- at major intersections or other locations where there is a tendency to drive slowly because of turning and crossing movements, warning devices, and traffic signals

The minimum curve radius is a limiting value of curvature for a given design speed and is determined from the maximum rate of superelevation and the maximum side friction factor selected for design. Very flat curves need no superelevation. In many instances, it is desirable to maintain a normal crown typical section on the roadway. In these cases, implementation of a curve with a radius flat enough as to not require superelevation should be considered.

4.5.3. Axis of Rotation

Roadway alignments are generally defined by a centerline (CL) and a profile grade line (PGL). The roadway may be rotated about various points on the typical section to achieve superelevation. Typically, the point of superelevation rotation (axis of rotation) corresponds to the PGL located on the inside edges of the travel lanes. On two-way roadways with a flush, raised or no median, the axis of rotation typically corresponds to the roadway centerline. Generally, rotation will occur about the centerline on roadways with an urban typical section. In most instances, the axis of rotation, the PGL or centerline and the pavement crown line are the same – although it is not mandatory. The following represent GDOT guidelines when establishing the location of the superelevation rotation point:

- For almost all situations involving two-lane, three-lane and four-lane (with raised median) typical sections, the axis of rotation is located on the centerline of the proposed pavement. One exception to this is three-lane section which is widened to one side from two-lane sections. In this case, the axis of rotation typically follows the location of the former centerline of two-lane pavement.
- The actual point of rotation with a raised median is an imaginary point which is developed by projecting the left and right pavement cross slopes respectively and intersecting them with the project centerline to form a common point.
- In four-lane and six-lane typical sections involving depressed medians, the axis of rotation generally follows the inside edge of the inside travel lane (Lane 1). This approach facilitates consistent median drainage but can create drainage problems near median breaks. Particular attention should be paid to pavement drainage in the areas near median breaks and should examine the pavement profile of the median break crossover.
- A point of rotation at the centerline where depressed medians are in urban areas or where there is a potential for future development and the addition of future crossovers should be

considered. In areas where superelevation rates would create median slopes greater than 4:1 it will be necessary to use split rotation points. When the median width is 44-ft. this typically occurs when the superelevation rate exceeds 5%.

- In a six-lane or 8-lane typical section involving a concrete median barrier, the axis of rotation will follow the lane line separating Lane 1 from Lane 2.
- In typical sections which involve more than three-lanes in each direction, the profile grade line (crown point or axis of rotation) will generally begin to move from its standard location on the inside edge of the inside travel lane towards the outside – in one-lane increments. This is due to the need to balance pavement drainage and to maintain practical superelevation transition and tangent runout lengths. There should never be more than a three-lane difference between the number of lanes on one side of the pavement “crown” vs. the other side.

Table 4.9. Superelevation Rotation Points and Rotation Widths, summarizes the location of the axis of rotation for various typical sections utilized by GDOT. For further information or more detail regarding typical sections, refer to **Chapter 6** of this Manual or consult the typical section cells associated with the *GDOT Electronic Data Guidelines*.

4.5.4. Superelevation Transitions

Development of Superelevation

For appearance and comfort, the length of superelevation runoff (and tangent runout) should be based on a relative gradient between the longitudinal grades of the axis of rotation and the outside edge of traveled way pavement. The maximum relative gradient is varied with design speed to provide longer runoff lengths at higher speeds and shorter lengths at lower speeds. The maximum relative gradients are depicted in **Table 4.10. Maximum Relative Gradients**. These values correspond to those found in the AASHTO Green Book.

Refer to the AASHTO *Green Book* for guidance on establishing superelevation runoff lengths, superelevation (tangent) runout lengths and locating superelevation transitions.

Table 4.9. Superelevation Rotation Points and Rotation Widths

No. of Lanes	Median Width (ft.)	Median Type	Barrier Inside	Barrier Outside	Symmetric Widening	Asymmetric Widening	New Location	Reconstruction	Horizontal Location of Rotation Point	Rotation Width (ft.)
Urban Typical Section										
2	0	N/A					X	X	CL	12
3	14	Flush			X		X		CL	19
3	14	Flush				X			CL of old pavement	26
5	14	Flush			X	X	X	X	CL	31
4	20	Raised			X	X	X	X	CL	34
6	20	Raised			X	X	X	X	CL	46
4	24	Raised			X	X	X	X	CL	36
6	24	Raised			X	X	X	X	CL	48
Rural Typical Section										
2	0	N/A					X	X	CL	12
3	14	Flush			X		X		CL	19
3	14	Flush				X			CL of old pavement	26
5	14	Flush			X	X	X	X	CL	31
4	20	Raised			X	X	X	X	CL	34
6	20	Raised			X	X	X	X	CL	46
4	24	Raised			X	X	X	X	CL	36
6	24	Raised			X	X	X	X	CL	48
4	32	Depressed			X	X	X	X	Inside of TL 1	24
6	32	Depressed			X	X	X	X	Inside of TL 1	-
4	44	Depressed			X	X	X	X	Inside of TL 1	24
6	44	Depressed			X	X	X	X	Inside of TL 1	-
Ramp Typical Section										
1*	0	N/A			X	X	X	X	Outside edge of TL	16
2*	0	N/A			X	X	X	X	Outside edge of TL 2	24
1*	0	N/A	X	X	X	X	X	X	Outside edge of TL	16
2*	0	N/A	X	X	X	X	X	X	Outside edge of TL 2	24
Limited Access Typical Section										
1*	0	N/A	X	X	X	X	X	X	Inside of TL 1	12
2*	0	N/A	X	X	X	X	X	X	Inside of TL 1	24
3*	0	N/A	X	X	X	X	X	X	Varies	-
4*	0	N/A	X	X	X	X	X	X	Varies	-
Hybrid Typical Section										
2	44	Depressed		X	X	X	X	X	Inside of TL 1	24
3	44	Depressed		X	X	X	X	X	Inside of TL 1	36
4	44	Depressed		X	X	X	X	X	Between TL 1 and TL 2	36
2	52	Depressed		X	X	X	X	X	Inside of TL 1	24
3	52	Depressed		X	X	X	X	X	Inside of TL 1	36
4	52	Depressed		X	X	X	X	X	Between TL 1 and TL 2	36
2	64	Depressed		X	X	X	X	X	Inside of TL 1	24
3	64	Depressed		X	X	X	X	X	Inside of TL 1	36
4	64	Depressed		X	X	X	X	X	Between TL 1 and TL 2	36
3	28	Flush w/ Barrier	X		X	X	X	X	Between TL 1 and TL 2	24
4	28	Flush w/ Barrier	X		X	X	X	X	Between TL 1 and TL 2	36
5	28	Flush w/ Barrier	X		X	X	X	X	Between TL 2 and TL 3	36
3	32	Flush w/ Barrier	X		X	X	X	X	Between TL 1 and TL 2	24
4	32	Flush w/ Barrier	X		X	X	X	X	Between TL 1 and TL 2	36
5	32	Flush w/ Barrier	X		X	X	X	X	Between TL 2 and TL 3	36
3	40	Flush w/ Barrier	X		X	X	X	X	Between TL 1 and TL 2	24
4	40	Flush w/ Barrier	X		X	X	X	X	Between TL 1 and TL 2	36
5	40	Flush w/ Barrier	X		X	X	X	X	Between TL 2 and TL 3	36
<p>* One-Way</p> <p>Notes: 1. Outside Typical Sections 2. Assume 12-ft. Lane Widths 3. On raised medians, PGL is located by projecting pavement cross slope to the centerline</p> <p>Symbols: CL = Centerline TL = Travel Lane</p>										

Table 4.10. Maximum Relative Gradients indicates that relative gradients vary per design speed.

Table 4.10. Maximum Relative Gradients

Design Speed (mph)	Maximum Relative Gradient, G (%)	Equivalent Maximum Relative Slope
15	0.78	1:128
20	0.74	1:135
25	0.70	1:143
30	0.66	1:152
35	0.62	1:161
40	0.58	1:172
45	0.54	1:185
50	0.50	1:200
55	0.47	1:213
60	0.45	1:222
65	0.43	1:233
70	0.40	1:250
75	0.38	1:263
80	0.35	1:286

A strict application of the maximum relative gradient criterion provides runoff lengths for four-lane undivided roadways that are double those for two-lane roadways; and those for six-lane undivided roadways would be tripled. While lengths of this order may be desirable, it is often not practical to provide such lengths in design. It is recommended that minimum superelevation runoff lengths be adjusted downward to avoid excessive lengths for multilane highways.

The recommended adjustment factors are presented in **Table 4.11. Adjustment Factor for Number of Rotated Lanes**. These values correspond with the values found in the AASHTO *Green Book*.

Table 4.11. Adjustment Factor for Number of Rotated Lanes

Number of Lanes Rotated (N_1)	Adjustment Factor (b_w)	Length Increase Relative to 1 Lane Rotated ($=N_1 b_w$)
1.00	1.00	1.00
1.50	0.83	1.25
2.00	0.75	1.50
2.50	0.70	1.75
3.00	0.67	2.00
3.50	0.64	2.25

Source: AASHTO Green Book.

To calculate minimum superelevation runoff length, use the equation:

$$L = \frac{(wN_1)e_d}{G} * (b_w)$$

where:

L = minimum length of superelevation runoff (ft.)

G = maximum relative gradient (%)

N_1 = number of lanes rotated (on one side of axis of rotation, not total number lanes)

b_w = adjustment factor for number of lanes rotated

w = width of one traffic lane (usually 12-ft.)

e_d = design superelevation rate (%)

For example, assume a five-lane roadway (12-ft. lanes) with 0.06 (6%) superelevation and 45 mph design speed. In the equation above, $G = 0.54$, $N_1 = 2.5$, $b_w = 0.7$, $w = 12$, and $e = 6.0$. Inserting these numbers into the equation gives:

$$L = \frac{(12)(2.5)(6)}{0.54} * (0.7) = 233.33 \text{ ft.}$$

Minimum Length of Superelevation Runoff

There are a number of rational approaches to transitioning from a normal crown section to a superelevated section. Wherever possible, GDOT applies $2/3$ of the superelevation runoff outside the curve and $1/3$ of the superelevation runoff inside the curve. For the above example, the amount of superelevation applied outside the curve would be $(2/3)(233.33) = 155.56$ -ft. and the amount of superelevation applied inside the curve would be $(1/3)(233.33) = 77.78$ -ft.

Tangent runout is the length required to transition from a normal crown to a flat section on the outside of a horizontal curve. The tangent runout length is determined in the same manner as the superelevation runoff length. For the example above, assuming a normal crown cross slope of 2%), the tangent runout length would be:

$$L = \frac{(12)(2.5)(2)}{0.54} * (0.7) = 77.78 \text{ ft.} \quad \text{length tangent runoff}$$

Calculated lengths may be rounded to the nearest foot, if desired.

If geometric constraints exist, consideration may be given to placing 50% of the superelevation runoff on the tangent and 50% of the runoff on the curve. Sometimes, conditions exist where it is not possible to develop the desirable amount of runoff (or runout) and it is impossible to locate the transition in the ideal location relative to the curve PC or PT.

Examples of this include:

- Reverse curves (especially prevalent in mountainous regions)
- Broken back curves
- Approaches to intersections

These undesirable situations should be avoided, wherever feasible. However, since these instances are sometimes unavoidable (or the desirable implementation is impractical) – professional judgment should be exercised when determining less-than-ideal transition rates and transition locations.

Some practical guidelines for handling these situations include:

- For a symmetric (equal radius) reverse curve, place the 0% cross slope point at the PT and PC common to both curves
- For asymmetric reverse curves (of different radii), attempt to place the superelevation transition in a location which is proportional to the e_{\max} of the two curves
- For broken back curves, attempt to place the average e_{\max} cross slope at the center of the tangent
- Pavement warping near intersection tie-ins is sometimes required (e.g. when there are superelevation transitions near intersections, PROWAG requirements, drainage, sight distance, and operations which should be taken into consideration)

Figure 4.1., Crowned Traveled Way Revolved About Centerline, illustrates the development of tangent runout and superelevation runoff for a roadway with the profile control and superelevation rotation point at the center of the roadway.

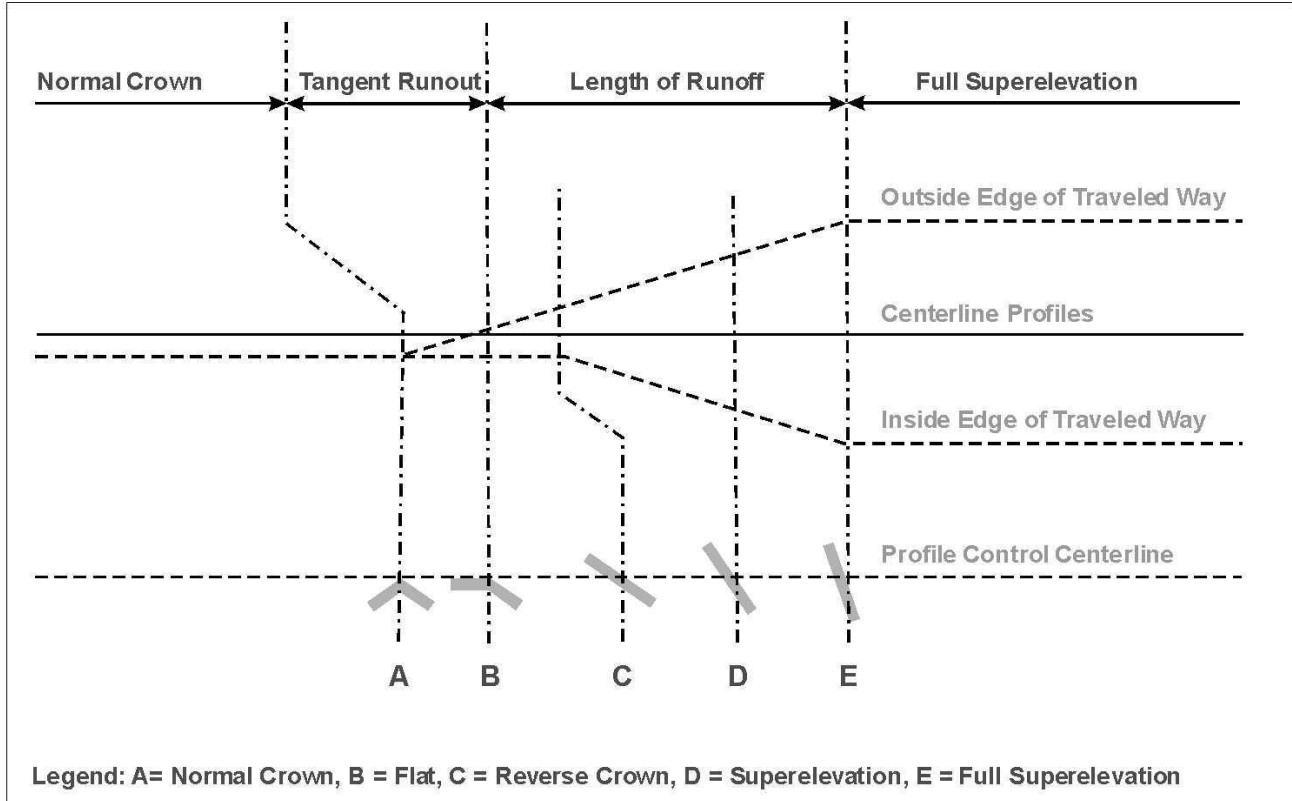

Figure 4.1. Crowned Traveled Way Revolved About Centerline

Chapter 5. Roadside Safety and Lateral Offset to Obstruction - Contents

- Chapter 5. Roadside Safety and Lateral Offset to Obstruction - Contents5-i
- 5.1 Overview.....5-1
- 5.2 Lateral Offset to Obstruction.....5-2
 - 5.2.1 Rural Shoulders.....5-2
 - 5.2.2 Urban Shoulders5-3
- 5.3 Lateral Offsets for Roadside Features.....5-4
 - 5.3.1. Sign Supports.....5-4
 - 5.3.2 Lighting Standards5-4
 - 5.3.3. Utility Installations.....5-5
 - 5.3.4 Signal Poles and Signal Cabinets5-6
 - 5.3.5 Trees and Shrubs.....5-7
- 5.4. Roadside Safety Hardware.....5-8
 - 5.4.1. Barrier Types.....5-8
 - 5.4.2. Barrier Location & Application5-10
 - 5.4.3. End Treatments.....5-12

Chapter 5. Roadside Safety and Lateral Offset to Obstruction

5.1 Overview

It is the goal of the Georgia Department of Transportation (GDOT) to provide and maintain a high quality statewide multimodal transportation system. Addressing roadside safety is key to achieving this goal. Promoting effective relationships with stakeholders is also a GDOT goal. Often, input from stakeholders regarding roadside amenities and design requires a proactive and ongoing coordination effort with stakeholders to achieve success. While these two goals may at times seem to be in competition with one another, it is important to recognize that each goal contributes to GDOT's ability to achieve its mission of providing a safe transportation system that is sensitive to the needs of its citizens and environment.

Features and elements generally encountered in roadside design for new construction or reconstruction projects are identified in respective sections of this chapter. Therefore, this chapter addresses the area outside of the actual traveled way which is also an important component of roadway design. Under certain circumstances, the policies described in this chapter may not be applicable to permitting on existing facilities or temporary conditions and facilities.

The GDOT standard minimum lateral offsets to obstructions are listed later in this chapter. However, the reader is cautioned that the offsets alone do not present a complete solution to allow features or objects on the shoulder or roadside.

Sound engineering judgment and reasonable environmental flexibility should be exercised in selecting and specifying roadside safety features at each location.

In addition to compliance with the requirements of this chapter, proposed lateral offsets should also consider the following - at a minimum:

- current traffic volumes;
- design year traffic volumes (for projects under design);
- truck percentages;
- current detailed crash history;
- posted speed limit;
- design speed (if available);
- operating speed (85th percentile, off peak);
- functional classification of the roadway;
- roadway setting/context (urban environment, rural, residential, commercial, historic district, etc.) and if the proposed project fits in with the roadway setting/context;
- existing operations (e.g. sight distance or vehicular operations), and the proposed project's affect on those operations;
- maintenance;

- existing roadside elements (e.g. permitted utilities or lighting) impacted/affected by the proposed project;
- proposed roadside elements and their consistency with the needs of the corridor (e.g. safety, utility, and aesthetic needs for pedestrian, bicycle, transit, vehicular traffic; consistency needs in terms of conformity with local, regional, and state roadside amenity values); and
- mitigation measures that should be considered (including the removal or relocation of fixed objects, the reduction of impact severity by implementing breakaway or traversable features, and the shielding of fixed objects with traffic barriers such as guardrail).

“Roadside” is defined in the *American Association of State Highway and Transportation Officials Roadside Design Guide* (AASHTO RDG) as the area between the outside shoulder edge and the right-of-way limits. In curb and gutter sections, the roadside is termed an urban shoulder (or urban border area), which is the part of an urban roadway which includes the curb and gutter, the sidewalk, and any space available for buffer and/or utilities. This area begins at the outside edge of roadway pavement and normally extends to the nearest of either the right-of-way limit or to the breakpoint of the fore-slope (-or back slope) that ties to the natural terrain.

5.2 Lateral Offset to Obstruction

Lateral Offset to Obstruction has been identified by the Department as having substantial importance to the operational and safety performance of a roadway such that special attention should be given to the design decision. Therefore, GDOT has developed criteria on “lateral offset to obstruction” for signs, light standards, utility poles, signal poles, controller cabinets, and trees and shrubs – refer to Section 5.3 of this Manual. A decision to use an offset value that does not meet the criteria defined by GDOT shall require a comprehensive study by an engineer and the prior approval of a Design Variance from the Chief Engineer.

5.2.1 Rural Shoulders

For a rural shoulder, lateral offset to obstruction is the horizontal distance measured from the edge of the traveled way, to the face of a vertical roadside object or feature. The rural shoulder is that part of the rural roadway, paved and/or graded flush with the edge of traveled way, which allows for emergency usage by vehicles.

Lateral offset to obstruction for rural type shoulders is based on the concept of clear zone that is established by the *AASHTO RDG*. By definition, clear zone is the area beyond the roadway edge of traveled way which provides an environment free of fixed objects, with stable, flattened slopes which enhance the opportunity for vehicle recovery and/or reducing crash severity. Fixed objects include trees, large shrubs, bodies of water, and elements of the roadway facility such as road signs, structure piers, utility poles or light standards, and electrical or controller cabinets, or other non-moveable objects that can pose a safety hazard to a vehicle and its occupants if the vehicle leaves the roadway.

In determining the acceptable clear zone for a particular roadway and prevailing conditions, refer to the current *AASHTO RDG* in its entirety, and not just to the tables provided in Chapter 3 of the Guide. Principles of clear zone include safe drainage structure end treatments, ditch design, curve

correction factors, and many other features that are key elements to the overall safe and aesthetically pleasing roadside design. It is not the intent of this Manual to reproduce the clear zone guidance that is provided in the AASHTO *RDG*.

The designer should provide the maximum clear zone that is commensurate and practical for the prevailing conditions. The maximum clear zone values, based on the traffic volume, slope, geometry and design speeds identified in the current AASHTO Roadside Design Guide should be utilized on new construction or when providing full reconstruction of the roadway. If it is not practical to provide the recommended maximum value due to overall highway design considerations, a lower value may be used. For retro-fit types of projects, achieving the minimum clear zone values is acceptable.

Features or objects located within the accepted clear zone for a roadside should comply with the guidelines provided in the AASHTO *RDG*. If features or fixed objects cannot be removed or modified to become clear zone compliant, they shall be shielded in a cost effective manner that is consistent with current practice and standards.

It is GDOT's policy that fixed objects in median areas of 64-ft or less that cannot be eliminated shall be treated with cost-effective shielding devices, such as guardrail, impact attenuators, or earth-mound redirection design.

In cases where road median widths are greater than 64-ft, but less than 84-ft, specific engineering judgment should be made by the designer. For medians wider than 84-ft, it is not necessary to protect fixed objects that are located near the center of the median and outside the required clear zone. All bridge columns should be protected regardless of median width.

For roadsides, it is GDOT's policy to shield objects that are within the defined clear zone. The intent of the designer should be to reduce the seriousness of the consequences of a vehicle leaving the roadway.

5.2.2 Urban Shoulders

For roadways with urban shoulders, it is often not practical to establish or provide a clear zone to accommodate motorists operating on the roadways. Instead, lateral offset to obstructions and breakaway devices are needed. Lateral Offsets to Obstructions for urban roadways is based on the specific vertical feature (or obstruction) being considered, and generally is related to a combination of environmental, operational and safety characteristics, both for pedestrians and vehicular traffic. A breakaway support refers to all types of sign, luminaire, and traffic signal supports that are designed to yield, fracture, or separate when impacted by a motorized vehicle.

The lateral offset of 1-ft, 6 in. from face of curb to face of fixed object stated in the AASHTO Green Book should be an absolute minimum lateral offset for urban roadways. Lateral offsets less than 1-ft, 6 in. shall require extensive documentation, justification, and mitigation. This offset is not intended to represent an acceptable safety design criteria. This offset is meant to provide sufficient clearance to keep the overhang of a truck from striking a vertical obstruction. A lateral offset of 3-ft should be provided at intersections.

On curbed roadways, GDOT measures lateral offset from the face of curb to the face of the vertical obstruction, this includes conditions where auxiliary or bicycle lanes are present. If there is additional pavement between the curb and travel lane (e.g., on-street parking), the lateral offset is

measured from the edge of the travel lane. For the case of 1.5-ft lateral offset criteria recommended by AASHTO, this distance will always be measured from the face of curb to face of fixed object.

Chapter 10 of the AASHTO RDG should be referred to in its entirety when making decisions relating to roadside safety in the urban environment. According to the AASHTO *RDG*, **Chapter 10, Roadside Safety in Urban or Restricted Environments**, uniform lateral offsets between traffic and roadside features is desirable. It is GDOT's intent to facilitate this principle as much as practical, using this design policy manual, ongoing education and collaboration with GDOT staff and participating stakeholders.

The GDOT *Pedestrian and Streetscape Guide* provides helpful information about the urban roadside usage and may be referred to, too better understand this environment.

5.3 Lateral Offsets for Roadside Features

5.3.1. Sign Supports

Sign supports in both rural and urban shoulder environments shall be frangible or breakaway, except where located outside the accepted clear zone for the roadway. Supports for overhead signs require shielding.

Rural Shoulders

For rural shoulder, overhead sign supports that are located within the accepted clear zone shall be shielded with barrier or guardrail.

Urban Shoulders

For urban shoulders, overhead sign supports should comply with the lateral offset requirements as defined in **Section 5.3.3 Utility Installations** for utility installations on urban shoulders. However, if this is not practical, the minimum allowable lateral offset from the face of curb to the face of the support is 6-ft.

5.3.2 Lighting Standards

High Mast Roadway Lighting

High mast lighting should be located outside the accepted clear zone, where practical. Otherwise, cost-effective shielding shall be provided in accordance with current standards for roadside barrier.

Roadway Lighting

Roadway lighting should be placed on or along the outside shoulders as described below. The size of the base must be considered when measuring lateral offset. Breakaway or frangible bases are generally wider than the pole.

Rural Shoulders

Light standards should be mounted outside the clear zone. Any light standards that are not located outside of the clear zone must be mounted on an AASHTO compliant breakaway mounting, or be appropriately shielded.

Urban Shoulders

In urban roadway conditions, light standards should be positioned as close to the right-of-way limit as possible. If it is not feasible, light standards shall be placed directly outside the sidewalk and at least 6-ft from the face of curb. Coordination of light standard placement with sidewalks and other roadside features shall ensure that any point narrowing of the sidewalk width provide at least 4-ft of clear unobstructed space, and also that the lights do not conflict with other permitted features or elements on the urban shoulder.

Normally, a breakaway mounting design should be used for urban shoulders. However, breakaway type designs may be imprudent at locations, such as adjacent to bus shelters or in areas where high volumes of pedestrians are expected.

Pedestrian lighting (non-roadway)

All pedestrian light standards should be located at the back of the sidewalk. If sidewalk is not present, the light standards should be placed a minimum of 6-ft from the face of curb.

5.3.3. Utility Installations

Utility installations are governed by the GDOT *Utility Accommodation Policy and Standards Manual (UAM)*. Designers should read and understand the referenced policy, in conjunction with the policies and guidelines set forth in the GDOT Design Policy Manual.

Rural Shoulders

Refer to **Table 5.1.** for GDOT minimum lateral offsets to utility installations on roadways with rural shoulders.

Table 5.1 Minimum Lateral Offsets to Utility Installations: Rural Shoulders

Posted Speeds	Slope Condition	GDOT Policy
< 60 mph	fill section with slopes 4:1 or flatter	Utility obstacles shall be located at least 30-ft from the edge of traveled way to the face of the obstacle
< 60 mph	fill section with slopes steeper than 4:1	When fill slopes steeper than 4:1 are encountered they are not considered as 'traversable and recoverable'. Consult the AASHTO Roadside Design Guide for guidance.
≥ 60 mph	all slope conditions	Utility obstacle shall be located outside the accepted clear zone for the prevailing conditions, or 30-ft, whichever is greater.

Urban Shoulders

The following guidelines should be followed when placing utilities on urban shoulders:

- Utility obstacles should be positioned as near as possible to the right-of-way or utility easement.
- Utility obstacles should be placed in keeping with the nature and extent of roadside development.
- Lateral offsets to utility obstacles are measured from the face of curb to the face of pole or obstacle.
- No utility obstacle shall encroach on current sidewalk clearances required by PROWAG.

For utility relocation on urban roadway projects, the utility offset shall be governed by design speed, ADT, etc. the designer shall conform to the minimum lateral offsets listed in **Table 5.2**.

Table 5.2 Minimum Lateral Offsets to Utility Installations: Urban Shoulders

Posted Speeds	Minimum Lateral Offsets
< 35 mph	6-ft
≥ 35 mph and < 45 mph	8-ft
= 45 mph	12-ft

5.3.4 Signal Poles and Signal Cabinets

Lateral Offsets to signal poles and controller cabinets for signals are designated by the GDOT Office of Traffic Operations Traffic Signal Design Guidelines.

Rural Shoulders

On roadways with rural shoulders, signal poles and controller cabinets for signals shall be located outside the clear zone.

Urban Shoulders

The lateral offsets to signal poles and controller cabinets for signals shall be located a minimum of 6-ft from face of curb or behind sidewalk, whichever is greater.

5.3.5 Trees and Shrubs

Guidance for trees and shrubs allowed on state routes is provided by the GDOT Office of Maintenance. This guidance can be found in Policy [6755-9 Policy for Landscaping and Enhancements on GDOT Right of Way](#). Additional guidance for placement of trees and shrubs is provided by the Office of Traffic Operations through the GDOT *Pedestrian and Streetscape Guide*. Utility and intersection sight distance requirements may affect the location and diameter size of proposed trees in border areas and clear zones.

Rural Shoulders

On roadways with rural shoulders, trees and shrubs shall be located outside the clear zone. On interstates, trees and shrubs should have a minimum lateral offset of at least 120% of the clear zone requirement. Allowing trees and shrubs in the clear zone without shielding will require an agreement with the Department or the facility owner (e.g. city, county, etc.).

Urban Shoulders

On roadways with urban shoulders and with a posted design speed of greater than or equal to 50 mph, trees and shrubs shall be located outside of the clear zone, unless an agreement has been granted from the Department or the facility owner (e.g. city, county, etc.). On roadways with urban shoulders with a posted design speed of 45 mph or less, refer to **Table 5.3**. for minimum lateral offsets for trees and shrubs. In addition to the minimum lateral offsets given in Table 5.3, the designer shall ensure there is a minimum of 1.5-ft from the face of curb to the face of tree at tree's mature growth.

Table 5.3 Minimum Lateral Offsets to Trees and Shrubs: Urban Shoulders

Posted / Design Speeds	Minimum Lateral Offset ⁽¹⁾
≤ 35 mph (Commercial Area ⁽²⁾)	4-ft 8-ft in median
≤ 35 mph	8-ft 8-ft in median
40 mph	10-ft 16-ft in median ⁽³⁾
45 mph	14-ft 22-ft in median ⁽³⁾
≥ 50 mph	Outside the clear zone

⁽¹⁾ From center of tree to face of curb

⁽²⁾ In a central Business District and/or where commercial businesses are typically directly adjacent to the right-of-way.

⁽³⁾ Small trees and shrubs that mature at <4" in diameter may be planted a minimum of 8 feet from the face of the curb in medians adjacent to 40 to 45 mph speeds. Tree size is diameter of the tree maturity, measured at dbh (4.5 feet) above the base of the tree. Certain situations may require an increased lateral offset for additional safety considerations. For rural shoulders, trees should be placed outside the clear zone. For Interstates, trees should have a minimum lateral offset of at least 120% of the clear zone requirement.

5.4. Roadside Safety Hardware

Chapters 5, 6, 8, and 9 of the AASHTO *RDG* provide details on the application and design of various barriers, including guardrail, cable, concrete median barriers, and end treatments. Recommendations on the layout and type of barrier to be used are usually obtained from the Office of Bridge and Structural Design when bridges are involved. All other applications are the responsibility of the designer.

5.4.1. Barrier Types

The following barrier types should be used under the various stated conditions:

- **Cable Barrier** – A flexible barrier capable of deflecting 12 ft or more when impacted. Cable barrier is typically used in the grassed medians of freeways. The designer shall account for the deflection when determining the location of the barrier. Guidance for the selection and use of cable barrier systems is provided in the National Cooperative Highway Research Program (NCHRP) publication [NCHRP Report 711, Guidance for the Selection, Use, and Maintenance of Cable Barrier Systems](#).
- **W-Beam Guardrail** – A semi-flexible barrier that will deflect up to 5 ft. W-beam may be used to prevent vehicles from crossing medians, traversing steep slopes or striking objects. Refer to the *GDOT Construction Standards and Details* for additional guidance for placement of guardrail behind curbs. All W-beam guardrail installed on new construction, widening and/or reconstruction projects shall be 31-inch height.

- **T-Beam Guardrail** – Similar to W-beam guardrail but deflects only 3 ft. T-beam is used on transitions from W-Beam to a Concrete Barrier. Refer to the *GDOT Construction Standards and Details* for additional guidance for placement of guardrail behind curbs.
- **Double Faced Guardrail** – Semi-flexible barrier capable of deflecting 5 ft. Double-faced guardrail is used in medians and other locations to prevent errant vehicles from crossing into opposing traffic.
- **Single Slope Concrete Barrier** – Rigid barrier with little or no deflection. Single slope concrete barrier is used for medians or side barrier directly in front of rigid objects that are near the traveled way. This includes walls and bridge bents. This is the preferred barrier for Freeways and new construction where Jersey shape barrier is not being retained.
- **Jersey Shaped Concrete Barrier** – Same uses as single slope concrete barriers. Jersey shaped concrete may be used on projects where portions of existing Jersey barrier can be retained to provide a consistent design and appearance. Jersey barrier cannot be retained when construction raises the pavement surface by 3 inches or higher than the bottom lip of the barrier.

Temporary Barriers

Information regarding the function, design, and maintenance of temporary barriers is presented in the following documents:

- *AASHTO Roadside Design Guide (Chapter 9)*
- *FHWA Manual on Uniform Traffic Control Devices (Part 6)*¹
- GDOT Specifications (Section 620)
- *GDOT Construction Standards and Details (Ga. Std. 4961, Details of Precast Temporary Barrier)*.

The following two types of temporary barrier are commonly used:

Method 1 – must be documented with an acceptance letter from FHWA as an NCHRP Report 350 longitudinal barrier at Test Level 3², or similarly accepted under MASH³ criteria. The GDOT Temporary Concrete Barrier (reflected in Ga. Std. 4961) has been accepted under the NCHRP Report 350 criteria at Test Level 3. Method 1 barrier may be suitable for roadway construction staging, including directly adjacent to slopes and trenches. However, the engineer should still consider the effects of the deflection when deciding the appropriate offset. Method 1 barrier is not

¹ FHWA. *Manual on Uniform Traffic Control Devices (MUTCD)*. The 2009 version of the MUTCD is available online at: <http://mutcd.fhwa.dot.gov/kno-2003r1.htm>

² TRB. National Cooperative Highway Research Program (NCHRP) Report 350, *Procedures for the Safety Performance Evaluation of Highway Features* (1992) – applies to roadside hardware accepted under NCHRP Report 350 prior to adoption of MASH (on January 1, 2011). Available online at: http://safety.fhwa.dot.gov/roadway_dept/road_hardware/nchrp_350.htm

³ AASHTO *Manual for Assessing Safety Hardware (MASH) 2nd Ed.* (2016). Available online at: https://bookstore.transportation.org/item_details.aspx?id=1539

suitable on bridges where the distance from the centerline of the barrier to the free edge of the bridge deck is less than or equal to 6 ft, measured perpendicular to the barrier.

Method 2 - must be documented with an acceptance letter from FHWA as an NCHRP Report 350 longitudinal barrier at Test Level 3, or similarly accepted under MASH criteria with a deflection no greater than 1 ft under test condition. A Method 2 barrier shall be used on bridges and bridge approaches where the distance from the centerline of the barrier to the free edge of the bridge deck is less than or equal to 6 ft measured normal to the barrier.

Refer to the current AASHTO *RDG* for further discussion on the safety, functional, and structural aspects of temporary barriers and their use.

5.4.2. Barrier Location & Application

Roadside Barrier

Roadside barriers are designed to redirect a vehicle striking the barrier from obstacles. Obstacles could be things such as sign posts, trees, boulders, non-recoverable slopes, water sources, etc. Barriers are placed in areas where a collision with the barrier is less of a hazard than the obstacle behind it. When conditions are applicable, removal of the obstacle is preferable to the installation of barrier. In certain situations barriers are used to protect other vehicles, pedestrians and cyclists. See the AASHTO *RDG* (Chapter 5) for roadside barrier guidance. See Figure 5.1 for guidelines for W-beam guardrail placement on new installations or full replacements.

When practical, provide a barrier with a minimum height of 42 inches when the edge of the bike lane is within 5 ft of a barrier or railing. This will reduce the potential for a bicyclist to fall over the barrier.

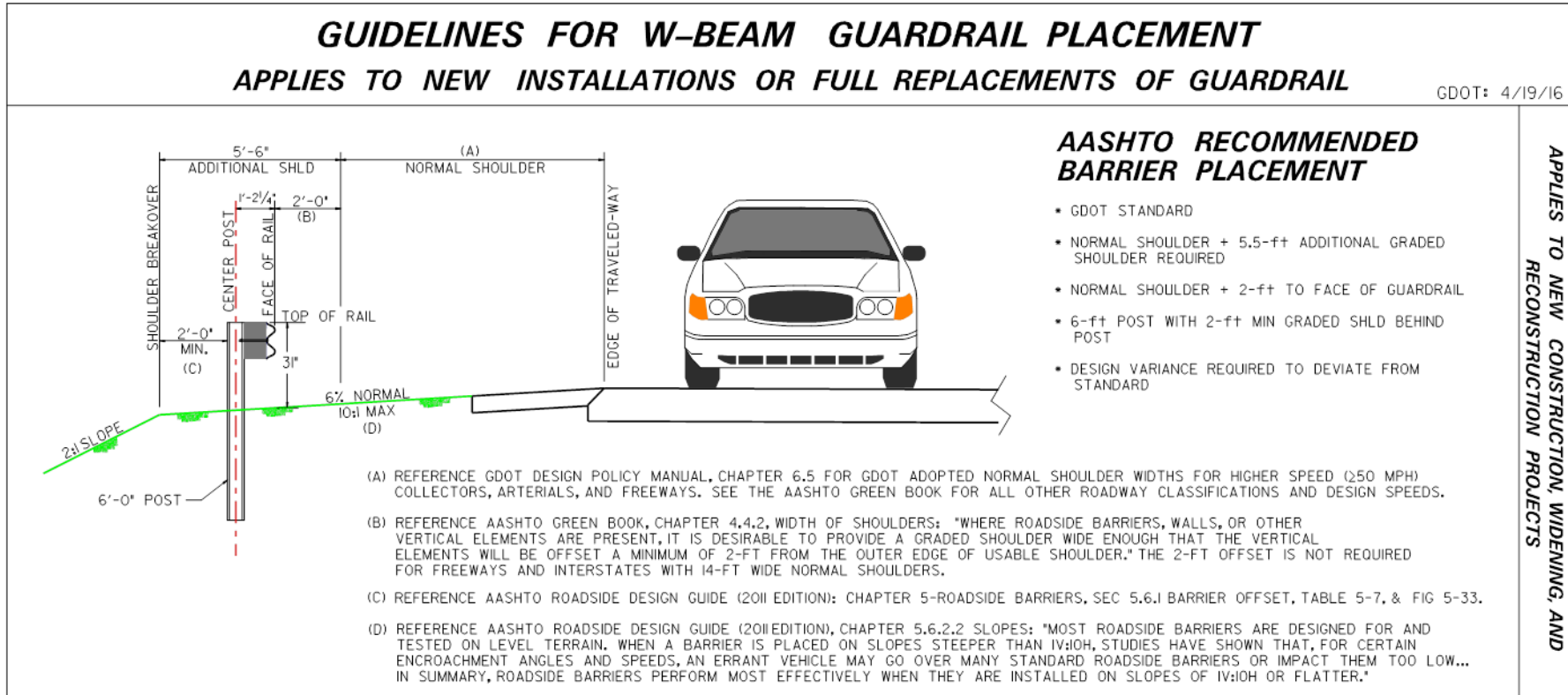

Figure 5.1 Guidelines for W-Beam Guardrail Placement

Median Barrier

Median barriers are designed to redirect a vehicle striking on either side of the barrier. Median barriers may be used on divided highways with or without full access control; however, median barrier may only be used on divided highways without access control for special situations on a case-by-case basis. Consideration for median barrier installation will be determined by traffic volume, vehicle mix, highway alignment, median width, terrain features, crash history, crossovers, right of way constraints, traffic operations, and sight distance. All access openings shall meet both intersection sight distance and stopping sight distance. Median barrier openings may be provided for authorized emergency vehicle crossovers and routine maintenance operations. When utilized proper end treatment must be provided. See the AASHTO *RDG* (Chapter 6) for median barrier guidance.

Glare Screens

Glare screens are required on all freeway concrete median barriers. Glare screens for concrete barriers are typically constructed as concrete extensions, but alternate materials may be used on a case-by-case basis.

A glare screen is required between the mainline and frontage roads with opposing traffic flows. Where concrete barriers are not used, a glare screen such as landscaping materials, fencing with inserts or walls may be used to minimize glare. With offsets greater than 40 ft, glare screens are not required but should be evaluated to determine if needed.

Length of Need

“Length-of-Need (LON) is defined as the length of barrier needed in advance (upstream) of a fixed object hazard or a non-traversable terrain feature to prevent a vehicle that has left the roadway from reaching the shielded feature. The LON calculation is defined and illustrated in Chapter 5 of the AASHTO *RDG* and on GDOT Standard Drawing 4000W. LON calculations should be performed by the design engineer and documented in the Project Design Data Book.

5.4.3. End Treatments

Crashworthy end treatments are required for all longitudinal barrier installations when those end treatments are located within the clear zone and exposed to possible vehicular impacts.

W-Beam Terminals

Terminals are crashworthy end treatments designed to eliminate spearing or vaulting when hit head-on, or redirect a vehicle away from the shielded object or terrain feature when the barrier is struck near the terminal. Below are the two types of w-beam terminals:

- Energy-Absorbing Terminals (Type 12A and 12B) – are designed to dissipate significant amounts of kinetic energy in a head-on impact and can stop vehicles in relatively short distances in head-on impacts (usually 50 feet or less depending on type of terminal).
- Non-Energy-Absorbing Terminals (Type 12C) – Include most flared designs and will allow an unbraked vehicle to travel 150 feet or more behind and parallel to guardrail installations or along the top of the barrier when struck head-on at high speeds.

The decision to use either an energy-absorbing terminal or a non-energy-absorbing terminal should be based on the likelihood of an end-on impact and the nature of the recovery area immediately

behind and beyond the terminal. If the barrier length-of-need is properly determined, it is unlikely that a vehicle will reach the primary shielded object after an end-on impact regardless of the terminal type selected. When an appropriate backslope exists near the end of the barrier, the buried-in-backslope terminal should be considered. When no suitable backslope exists, either a non-energy-absorbing or energy-absorbing may be appropriate. When barrier installations are less than 150 feet in advance of any shielded object or when total length of barrier installations are less than 150 feet, an energy-absorbing terminal should be selected. For additional information, refer to Chapter 8 of the current AASHTO *RDG*, applicable GDOT Construction Standards and Details, and the below link to the FHWA Safety website:

http://safety.fhwa.dot.gov/roadway_dept/policy_guide/road_hardware/policy_memo/memo052615/memo052615_attachment.cfm

See Figure 5.2 for the end terminal selection flowchart.

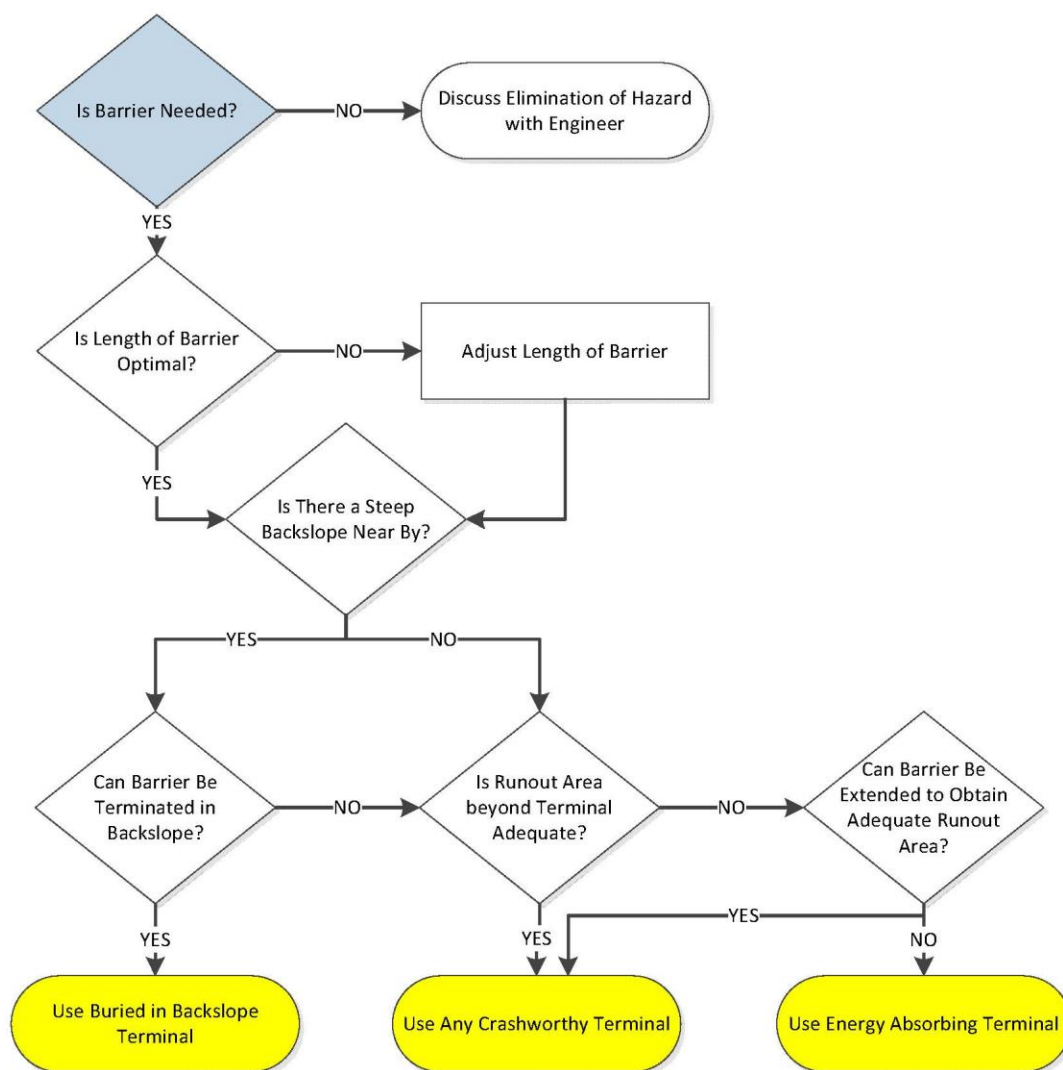

Figure 5.2 End Terminal Selection Flowchart

Crash Cushions

Crash cushions, also known as impact attenuators, are protective devices that significantly reduce the severity of impacts with fixed objects. This is accomplished by gradually decelerating a vehicle to a safe stop for head-on impacts and by redirecting a vehicle away from the fixed object for side impacts. Crash cushions are generally used to shield hazards in freeway gore areas or the ends of permanent or temporary traffic barriers. Crash cushions are classified as the following:

- **Type P** – The letter "P" designates a permanent (non-gating) installation that is considered reusable. Reusable installations have major components that may be able to survive multiple impacts intact and can be salvaged when the unit is being repaired. Some of the components, however, need to be replaced after a crash to make the entire unit crashworthy again.
- **Type S** – The letter "S" designates a permanent (non-gating) installation that is considered low-maintenance and/or self-restoring. Low-Maintenance and/or self-restoring installations either suffer very little, if any, damage upon impact and are easily pulled back into their full operating condition, or they partially rebound after an impact and may only need an inspection to ensure that no parts have been damaged or misaligned.

See Figure 5.3 for crash cushion selection criteria.

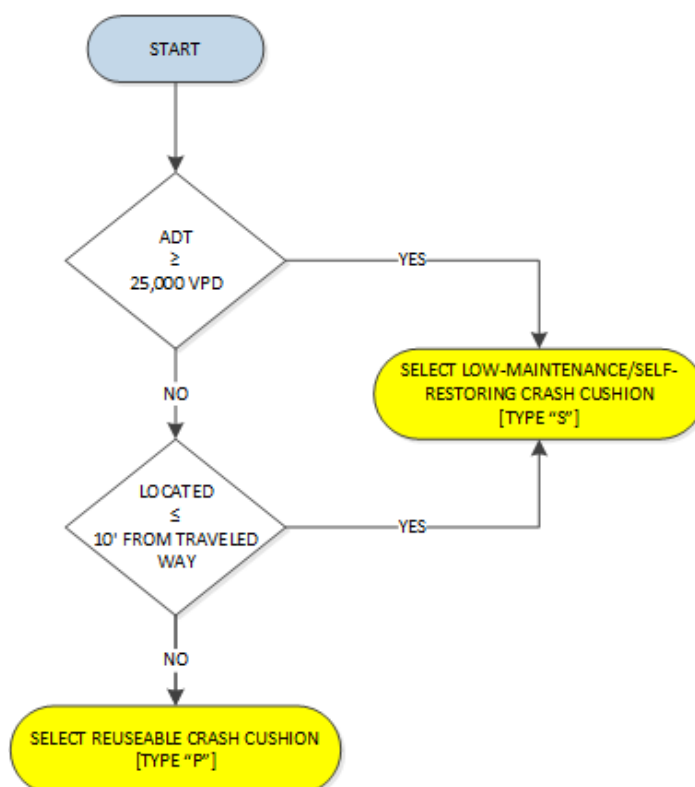

Figure 5.3 Crash Cushion Selection Flowchart

For additional information, refer to the current AASHTO *RDG*, Chapter 8, and all applicable GDOT *Construction Standards and Details*.

Blunt ends are acceptable in urban areas where the blunt end is equal to or beyond the lateral offset specified in this chapter. For this condition, the end shall be tapered with a 6:1 slope. For additional information, refer to the current AASHTO *RDG*, Chapter 8, and all applicable GDOT *Construction Standards and Details*.

Intentionally Left Blank

Chapter 6. Cross Section Elements - Contents

Chapter 6. Cross Section Elements - Contents	6-i
6.1 Lane Width	6-1
6.2 Pavement Type Selection.....	6-1
6.3 Cross Slope	6-1
6.4 Pavement Crowns	6-1
6.5 Shoulders	6-2
6.5.1 Rumble Strips.....	6-3
6.5.2 Pavement Edge Treatment	6-4
6.6 Side Slopes	6-5
6.7 Border Area (urban shoulder).....	6-6
6.8 Bike Lanes.....	6-6
6.9 Curbs	6-6
6.9.1 Curb Types.....	6-8
6.9.2 Methods of Construction	6-9
6.9.3 Raised Median Noses	6-10
6.9.4 Raised Channelizing Islands	6-10
6.10 Sidewalks	6-12
6.11 Barriers	6-12
6.12 Medians	6-12
6.12.1 Freeway Medians	6-13
6.12.2 Arterial Medians	6-13
6.12.3 Medians at Pedestrian Crossings.....	6-15
6.13 Parking Lanes.....	6-15
6.14 Noise Barriers.....	6-16
6.14.1 The Environmental Process	6-16
6.14.2 Design of Noise Walls	6-17
6.14.3 Construction Plan Requirements.....	6-19
6.14.4 Construction	6-20
6.15 Summary of Design Criteria for Cross Section Elements.....	6-20

Chapter 6. Cross Section Elements

6.1 Lane Width

“Lane width” has been identified as a "controlling criteria" that has substantial importance to the operational and safety performance of a roadway such that special attention should be given to the design decision. Therefore, GDOT adopts the AASHTO Green Book, “A Policy on Geometric Design of Highways and Streets,” and AASHTO “A Policy on Design Standards - Interstate System” criteria as the standard for lane width options for roadway classifications in Georgia. A decision to use a lane width value that does not meet the minimum controlling criteria defined by AASHTO shall require a comprehensive study by an engineer and the prior approval of a Design Exception (high speed roadways) or Design Variance (low speed roadways) from the GDOT Chief Engineer.

6.2. Pavement Type Selection

The designer should refer to the current GDOT *Pavement Design Manual* and the *GDOT Plan Development Process* manual for guidance relating to pavement type selection.

6.3. Cross Slope

“Cross slope” has been identified as a "controlling criteria" that has substantial importance to the operational and safety performance of a roadway such that special attention should be given to the design decision. Therefore, GDOT adopts the AASHTO Green Book, “A Policy on Geometric Design of Highways and Streets,” and the AASHTO “A Policy on Design Standards – Interstate System” criteria as the standard for cross slope options for roadway classifications in Georgia. A decision to use a cross slope value that does not meet the controlling criteria defined by AASHTO shall require a comprehensive study by an engineer and the prior approval of a Design Exception (high speed roadway) or Design Variance (low speed roadway) from the GDOT Chief Engineer.

Typical practice is to provide a 2% pavement cross-slope for travel lanes. On multi-lane roadways, no more than two adjacent lanes should be constructed at the same cross slope. The cross slope may be broken at 1% intervals not to exceed 3% on any lane. If necessary, when 3 or more lanes are sloped in the same direction and the profile grade is $\leq 0.3\%$, a 4% cross slope may be used to facilitate roadway drainage in areas of intense rainfall. A decision to use a 4% cross slope along a tangent roadway should be documented with an engineering study and placed in the project record.

6.4. Pavement Crowns

There are four categories of pavement crowns:

- **One-way Tangent Crown:** A one-way tangent crown slopes downward from left to right as viewed by the driver. It is used for all roadways providing one-way traffic, except as noted in the following paragraphs.
- **Two-way Tangent Crown:** A two-way tangent crown has a high point in the middle of the roadway and slopes downward toward both edges. It is used for all roadways providing two-

way traffic. For divided multi-lane highways, the pavement is sloped downward and away from the median centerline, or from the left or **right edge line of the median lane on a five-lane section**.

- **Two-way Crown Converted to One-way Use:** When an existing roadway with a two-way crown is converted from two-way to one-way use, the existing crown shape can remain.

However, if possible, leveling may be used to adjust cross-slope in order to obtain a constant cross-slope.

- **Cross-over Crown Break:** The cross-over crown break between main lanes is limited to an algebraic difference of 4% (0.04 ft/ft). This applies at the break point of a two-way crown. The algebraic difference between the main roadway cross-slope and shoulder cross-slope should not exceed 8% (0.08 ft/ft).

6.5. Shoulders

AASHTO defines a shoulder as, "the portion of the roadway contiguous with the traveled way that accommodates stopped vehicles, emergency use, and lateral support of the subbase, base and surface courses." **"Shoulder width" has been identified as a "controlling criteria" that has substantial importance to the operational and safety performance of a roadway such that special attention should be given to the design decision. Therefore, GDOT adopts the AASHTO Green Book, "A Policy on Geometric Design of Highways and Streets," and the AASHTO "A Policy on Design Standards – Interstate System" criteria as the standard for shoulder width options for roadway classifications in Georgia. A decision to use a shoulder width value that does not meet the minimum controlling criteria defined by AASHTO shall require a comprehensive study by an engineer and the prior approval of a Design Exception (high speed roadways) or Design Variance (low speed roadways) from the GDOT Chief Engineer.**

Research has indicated that shoulder width has the largest effect on crash frequency and traffic speed of any of the controlling criteria for rural highways¹. Therefore, GDOT has adopted 10-ft as the typical overall shoulder width for higher volume (ADT >2000) and higher speed (≥ 50 mph) rural collector and rural arterial roadways in Georgia. For high speed freeways and interstates, GDOT has adopted 14-ft as the typical overall outside shoulder width with 12-ft paved adjacent to the traveled way, and 12-ft as the typical overall inside shoulder width with 10-ft wide paved adjacent to the traveled way. **A decision to use a shoulder width value that does not meet the adopted criteria defined by GDOT shall require a comprehensive study by an engineer and the prior approval of a Design Variance from the Chief Engineer.**

On high speed freeway sections with six or more lanes, where truck traffic exceeds 250 DDHV, a paved inside shoulder width of 12-ft should be considered. Interstate ramp shoulders should be 12-

¹ See *NCHRP Report 783, Evaluation of the 13 Controlling Criteria for Geometric Design* for additional information.

ft wide outside with 10-ft paved adjacent to the traveled way, and 8-ft wide inside with 4-ft paved adjacent to the traveled way.

The adopted dimensions given above are consistent with the AASHTO desirable criteria for normal shoulder width along high-type facilities (see AASHTO Green Book, Ch. 4, Cross Section Elements) and the AASHTO *A Policy on Design Standards-Interstate System* (two additional feet were added for pavement stability). See Table 6.5, Table 6.6, and Table 6.7 for more information.

The typical shoulder cross-slope for total shoulder width and paved shoulder width established by GDOT is 6% for outside shoulders and 4% for shoulders within the median of a multilane roadway. This can vary depending on project specifics. For instance, on some projects the paved shoulder cross-slope matches the roadway cross-slope. On four-lane divided highways, the cross-slope on the median shoulder in tangent section is controlled by the cross-over crown restrictions described in **Section 6.4** of this Manual. Similarly, the outside shoulder cross-slopes (the convex side of the curve) on superelevated roadways will be controlled by the cross-over crown restrictions. As a result, the slope will depend on the superelevation rate.

On superelevated roadways, the inside shoulder will maintain its normal crown slope for superelevation rates equal to or less than the normal shoulder slope. For superelevation rates greater than the normal shoulder rate, the inside shoulder slope is the same as the superelevation rate of the roadway. For additional discussion of the superelevation, refer to Chapter 4 of this Manual.

6.5.1. Rumble Strips

Rumble strips have been identified by GDOT as having substantial importance to the operational and safety performance of a roadway such that special attention should be given to the design decision. Therefore, GDOT has defined the criteria in Table 6.1 as the standard for placement of rumble strips. **If it is not practical to provide rumble strips, then a decision to omit shall require a comprehensive study by an engineer and the prior approval of a Design Variance from the GDOT Chief Engineer.**

Table 6.1. Rumble Strip Placement

Roadway Type	Rumble Strip Placement
Interstate / Freeway ⁽¹⁾	Continuous, Detail T-25
Rural Shoulder ≥ 4ft Paved	Skip Shoulder, Detail T-23B & T-25
Rural Shoulder ≥ 2ft and < 4ft Paved	Skip Edge Line, Detail T-23A & T-25
Rural Shoulder < 2ft Paved	Continuous Edge Line, Detail T-23A & T-25
⁽¹⁾ Where bicycles are NOT allowed	

Rumble strips shall be used as follows:

- for rural shoulder where the design speed is ≥ 40 mph;
- rumble strips are to be the milled-in type; and
- for concrete roadways that may be widened in the future contact the Office of Design Policy and Support for an acceptable alternate to milled rumble strips.

Refer to GDOT Construction Detail T-23A, T-23B, T-23C, and T-25 for drawings showing the placement of the rumble strips. A paved 6.5-ft shoulder should be provided on all multi-lane divided roadways with rural shoulders where bicycle warrants are met (refer to **Section 9.4.2 Bicycle Warrants** of this manual). Under special circumstances, GDOT Construction Details T-19 and T-24 provide other applications for various rumble strip/rumble patch devices.

6.5.2. Pavement Edge Treatment

The pavement edge treatment described below, also known as a Safety Edge, has been identified by GDOT as having substantial importance to the operational and safety performance of a roadway such that special attention should be given to the design decision. Therefore, GDOT has defined the Safety Edge as the standard treatment for the outside edge of all uncurbed pavements, whether edge of travel lane or shoulder (excluding pavement behind guardrail). If it is not practical to provide the Safety Edge, then a decision to omit shall require a comprehensive study by an engineer and the prior approval of a Design Variance from the GDOT Chief Engineer.

The configuration of the safety edge for asphalt pavement is shown in Figures 6.1a and 6.1b, and for concrete pavement in Figures 6.2a and 6.2b. Refer to GDOT Construction Detail P-7 for additional details. The Safety Edge placement should be noted on the construction plan typical sections, with reference to GDOT Construction Detail P-7 for details and method of quantity calculation.

The safety edge may be used for treating temporary vertical pavement edges during construction operations, refer to special provision 150.06G. This decision should be evaluated by the engineer based on such factors as traffic volumes and how long the temporary pavement will be in use. Additional information about the [Safety Edge](http://safety.fhwa.dot.gov/roadway_dept/pavement/safedge/) is provided on the FHWA Safety Program web page at http://safety.fhwa.dot.gov/roadway_dept/pavement/safedge/.

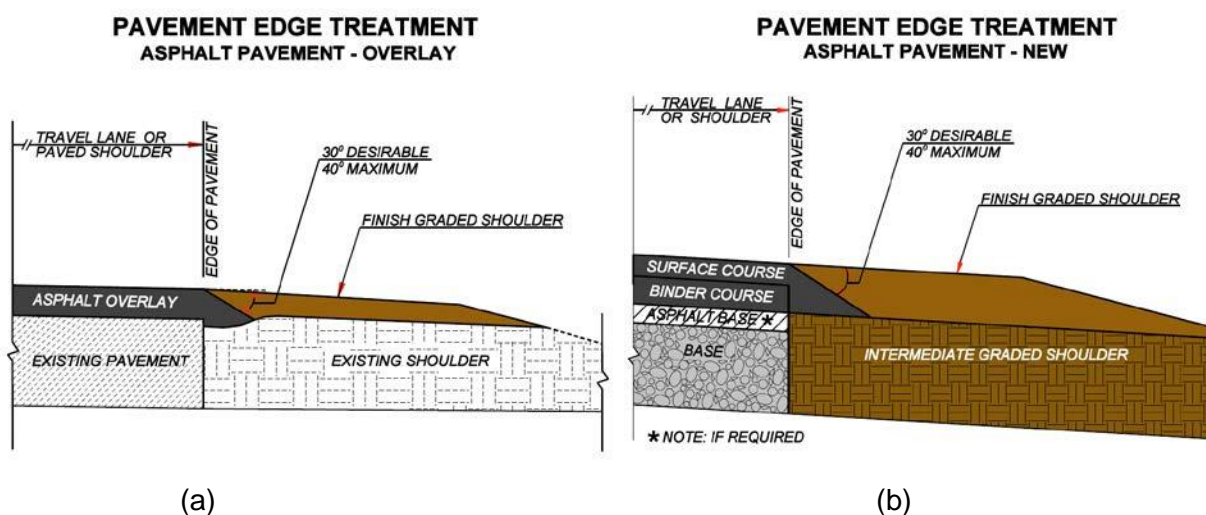
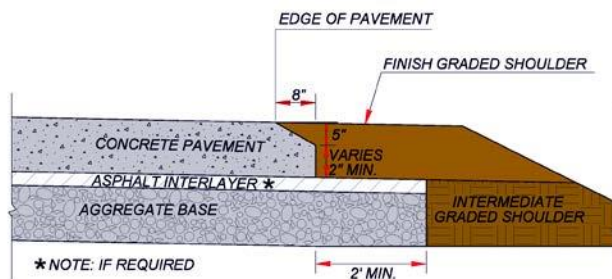

Figure 6.1a, b. Pavement Edge Treatment for Asphalt Pavement.

PAVEMENT EDGE TREATMENT
PLAIN PC CONCRETE PAVEMENT
OR ROLLER COMPACTED CONCRETE PAVEMENT



(a)

PAVEMENT EDGE TREATMENT
CONTINUOUS REINFORCED CONCRETE PAVEMENT

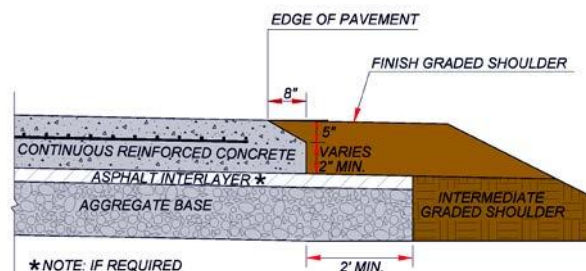

(b)

Figure 6.2a, b. Pavement Edge Treatment for Concrete Pavement.

6.6. Side Slopes

The AASHTO *Roadside Design Guide* specifies the maximum (steepest) side slope that should be used on a project in order to meet clear zone requirements. Where a range of slopes is given, the Designer should strive to provide as flat a slope as practical.

All front slopes (foreslopes) should be 4:1 or flatter, and no steeper than 2:1. GDOT discourages the use of 2:1 front slopes with guardrail unless economic constraints (construction costs, right-of-way impacts, or environmental impacts) outweigh the practicality of a 4:1 front slope.

GDOT prefers the use of 6:1 front slopes on ditch sections with design speeds ≥ 65 mph; however, 4:1 front slopes are allowed as long as clear zone requirements are met.

A "barn roof" is a roadway side slope that begins with a shallow slope, and is followed by a steeper traversable slope to allow the embankment to tie into the existing ground quicker than the shallower slope would. This reduces the amount of embankment and right-of-way required to construct the roadway. Figure 3.2 of the *Roadside Design Guide* shows an acceptable barn roof configuration. This figure shows a recoverable slope followed by a steeper non-recoverable 3:1 slope. This design provides a traversable side slope from the roadway to the bottom of the embankment.

Although a "barn roof" with a 2:1 side slope outside of the clear zone technically complies with clear zone requirements, vehicles leaving the roadway have a tendency to travel to the bottom of any slope, including recoverable slopes. For this reason, barn roof is generally not acceptable if the front slope includes a non-traversable 2:1 front slope.

In addition to the safety benefits, in urban and residential areas, slopes 4:1 or flatter can be mowed easily with a lawnmower. Efforts to save trees and other items sometimes complicate this procedure, and each residential lot should be addressed separately. Configurations should result in both a pleasing appearance and an easily maintainable configuration.

Refer to **Chapter 5, Roadside Safety and Lateral Offset to Obstruction** of this Manual and the AASHTO *Roadside Design Guide*, Chapter 3 for further discussion about roadway side slopes.

6.7. Border Area (urban shoulder)

Typically referred to as an "urban shoulder," the AASHTO Green Book (Ch.4, Cross-Section Elements - Pedestrian Facilities) defines "border area" as, "in suburban and urban contexts, a border area generally separates the roadway from a community's homes and businesses. The main function of the border is to provide space for sidewalks...streetlights, fire hydrants, street hardware, and aesthetic vegetation, and to serve as a buffer strip."

GDOT defines the limits of the border area on urban type projects to be from the outside edge-of-pavement outward, and to include the gutter, the curb, the sidewalk and any space available for buffer and/or utilities. GDOT encourages the use of a 16-ft wide border area on urban type projects, where right-of-way permits. When a roadway has multiple driveways, a 16-ft wide border area provides the buffer space needed to construct a sidewalk at a consistent 6-ft offset from the back of curb and to align with the back of a standard driveway concrete valley gutter. If a 16-ft wide border area is not practical, then a border area \geq 10-ft wide is acceptable. In all cases, the sidewalk design must comply with PROWAG regulations. See **Section 9.5.1 Pedestrian Facility Design** of this Manual for design criteria relating to sidewalks and pedestrian facilities in Georgia.

6.8. Bike Lanes

See **Section 9.5.2 Bicycle Facility Design** for design criteria relating to bicycle facilities in Georgia.

6.9. Curbs

The type and location of curbs affects driver behavior and the safety and utility of a highway. Curbs serve any or all of the following purposes:

- drainage control;
- pavement edge delineation;
- right-of-way reduction;
- aesthetics;
- delineation of pedestrian walkways;
- reduction of maintenance operations; and
- assistance in orderly roadside development.

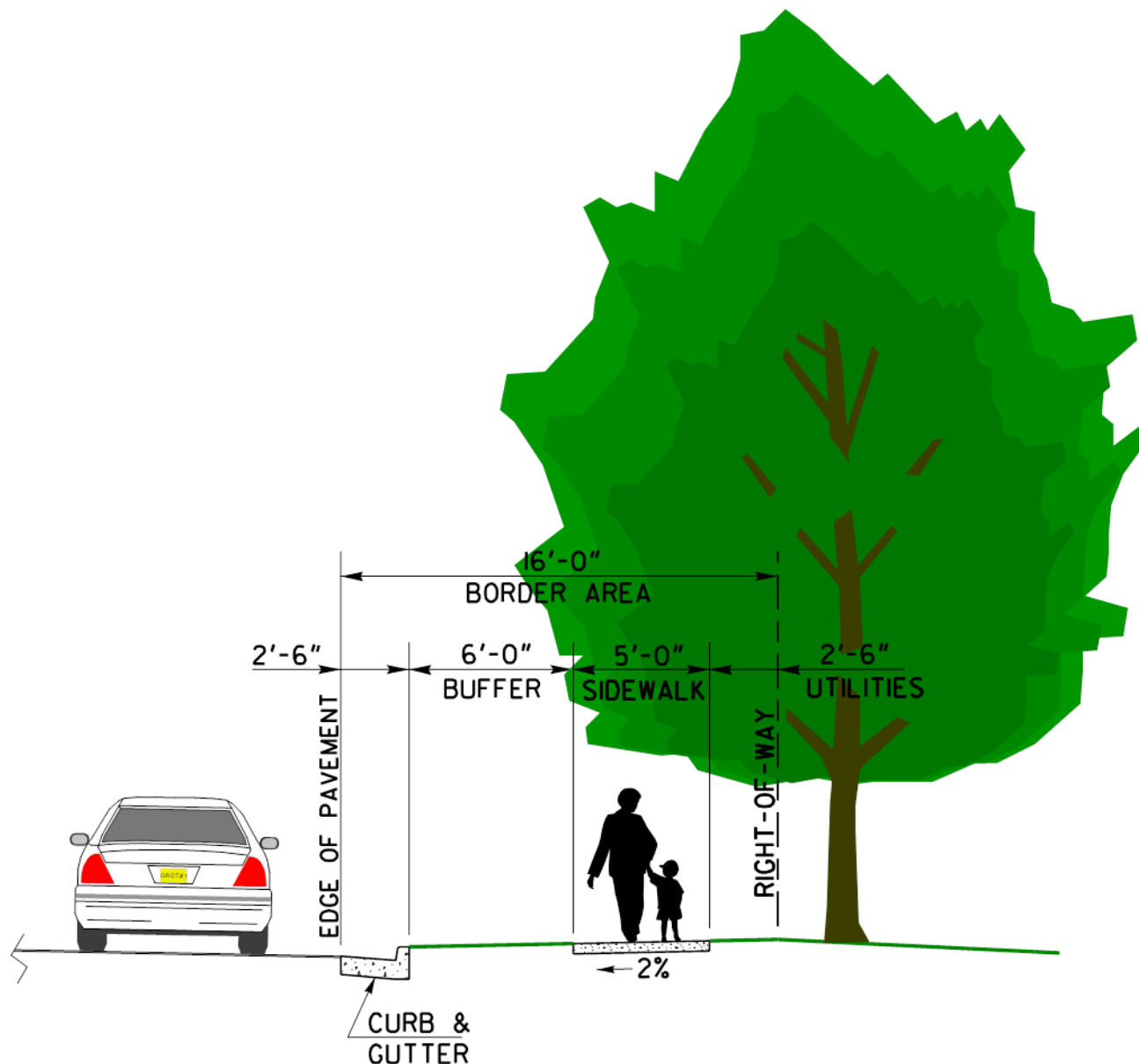

Figure 6.3. Illustrates the dimensions of a 16-ft wide border area.

The AASHTO Green Book states that vertical curbs should not be used along freeways or other high-speed (i.e., ≥ 50 mph) roadways, but if a curb is needed, it should be of the sloping type. Where used for pavement drainage or to intercept runoff from the roadside, V-gutter (with appropriately spaced inlets) is preferred over sloped curb.

For roadways with a design speed ≥ 50 mph, sloped curb faces on outside shoulders should be offset to the back of paved shoulder. The width of the paved shoulder should be at least 10-ft. For multi-lane divided roadways with a design speed ≥ 50 mph, sloped curb faces on inside shoulders should be offset at least 4-ft from the inside edge of travel lane.

Curbs may be constructed by a variety of methods. Typical shapes and dimensions for various types of curbs, including curb and gutter, are shown in GDOT Construction Standards and Details Ga. Std. 9032B.

The relationship of curb-to-guardrail is critical. If the curb is not properly located, the guardrail will not function as intended. Chapter 5 of the AASHTO *Roadside Design Guide* discusses the location of curb with respect to the face of the guardrail. For additional information, refer to GDOT *Construction Standards and Details*, Ga. Std. 4391. See also **Section 5.4 of this Manual**.

6.9.1. Curb Types

Sloped Curbs or Barrier Curbs

Curb shapes are generally classified as either sloped or barrier curbs. The sloped curb has a flat sloping face. The barrier curb has a characteristic steep face.

- Generally, barrier curb is only used when sidewalks are provided on a rural shoulder and in a corresponding curb return of turnouts to intersecting streets. See **Table 6.2** for proper use of curb.

Concrete or Asphaltic Curbs

Portland cement concrete is used for most curbs. Asphaltic curbs are limited primarily to header curbs in parking areas. Asphaltic curbs are sometimes used behind guardrail along rural shoulders to control pavement runoff, in order to protect highly erodible fill side slopes. The engineer shall coordinate with the Office of Construction and Design Policy & Support to determine when to use asphaltic curb.

Table 6.2. Curb Types Allowed for Various Types of Roads

Curb Type ⁽¹⁾	Road Type				
	Freeway	Urban	State Route Design Speed ≤ 45 mph	State Route Design Speed ≥ 50 mph	Other Off Roadway Classification
Concrete Curb and Gutter					
Type 1					X
Type 2		X	X		X
Type 3					X
Type 4					X
Type 7		X	X	X	X
Concrete Header Curb					
Type 1					X
Type 2		X	X		X
Type 3					X
Type 4					X
Type 7		X	X	X	X
Type 8		X	X	X	X
Raised Median					
Type 1					
Type 2			X		
Type 7	X	X	X	X	
Raised Island					
Type 1					
Type 2			X		
Type 7		X	X	X	
V Gutter					
	X	X			
⁽¹⁾ Typical shapes and dimensions for various types of curbs, including curb and gutter, are shown in Ga. Std. 9032B. Four-inch sloped Type I curbs placed at the back of the usable shoulder may be used on high speed facilities. For curbs on roundabouts see Section 8.3.9 of this Manual.					

6.9.2. Methods of Construction

Integral Curb

For concrete pavements, integral curb is preferred to curb and gutter because of economy in initial construction and maintenance. With this method, the concrete curb is poured when the concrete slab for the roadway is still in a plastic state. This creates an integral bond between the roadway and the curb. An alternate (and more popular) method of construction is to place tie bars in the concrete of the roadway slab. Later, when the pavement has hardened, the curb is poured so that the tie bars hold the curb firmly in place on the roadway. Although not truly integral with the pavement, this curb is commonly referred to as integral/tied curb. The depth of integral/tied curb should match the depth of the roadway slab.

Curb and Gutter

Concrete curb and gutter, as shown in the *GDOT Construction Standards and Details*, Ga. Std. 9032B, is generally used with asphaltic concrete pavement. Under this method, both the curb and the gutter are poured together, but not at the same time as the roadway pavement. The GDOT

standard curb and gutter width is 2.5-ft for both sloped and barrier type curb and gutter. Where curb and gutter is placed adjacent to concrete pavement on curbed sections, tie bars should be used to connect the curb and gutter to the adjacent pavement. This prevents separation of the curb and gutter from the edge of the pavement.

Under restrictive right-of-way conditions, a 2-ft wide curb and gutter (i.e., 6-inch curb, 18-inch gutter), as shown in the GDOT Construction Standards and Details Ga. Std. 9032C, may be used on state routes in Georgia. The designer should note that reducing the gutter width by 6-inches will also reduce the gutter hydraulic capacity and thus may increase the number of drainage structures required to control gutter spread. In addition, a reduced gutter width will require a deeper drop inlet structure (See Ga. Std. 1019C). Therefore, a decision to use a 2-ft wide curb and gutter will require the following:

- For new construction or reconstruction, an engineering study and approval by the State Design Policy Engineer/Hydraulics Engineering Group. The engineering study must certify that the right-of-way and material savings benefit exceed the cost of additional drainage structures required to mitigate the reduced gutter capacity.
- For minor changes to the roadway such that the existing longitudinal drainage system remains in place, a calculation and approval by the State Design Policy Engineer/Hydraulics Engineering Group. The calculation must demonstrate acceptable gutter spread for the appropriate design storm event(s).
- Approval is not required where the function of the 2-ft wide curb and gutter is to match an existing 2-ft curb and gutter.

Please contact StandardsAndDetails@dot.ga.gov to request copies of the 2' C&G Georgia Construction Standards (i.e., Ga. Stds. 9032C, 1019C, etc.).

Header Curb

For State Routes and NHS roadways, the use of header curb without an offset distance to the travel lane will only be allowed under restrictive right-of-way conditions. GDOT places great consideration on curb placement next to the travel lane. This topic is addressed in the AASHTO Green Book. The removal of curb and gutter and replacement with header curb on a NHS or State Route will require the prior approval of the Office of Design Policy and Support. Projects with a concept approval date of June 1, 2019 or prior will be allowed to remain as designed.

6.9.3. Raised Median Noses

To prevent vehicles from breaking the curb in the nose of raised medians, a monolithic section of curb and median pavement should be constructed. See *GDOT Construction Standards and Details*, Construction Details of Median Crossovers (M-3).

6.9.4. Raised Channelizing Islands

Raised channelizing islands help control and direct the movement of traffic by reducing excess pavement areas in order to channelize turning movements at intersections. In urban locations, a sloped curb is generally used in conjunction with striping to delineate the island. In rural locations where higher speeds are likely, islands are typically delineated with a sloped curb and offset appropriately. In areas with crosswalks where raised islands will be used for pedestrian refuge, the

When the raised island size does not meet pedestrian size, a semi-depressed island can be used which is shown in Figure 6.4b below. Refer to Chapter 9, Intersections-Islands, of the current AASHTO Green Book, and Chapter 4 of the current GDOT Regulations for Driveway and Encroachment Control manual for additional information.

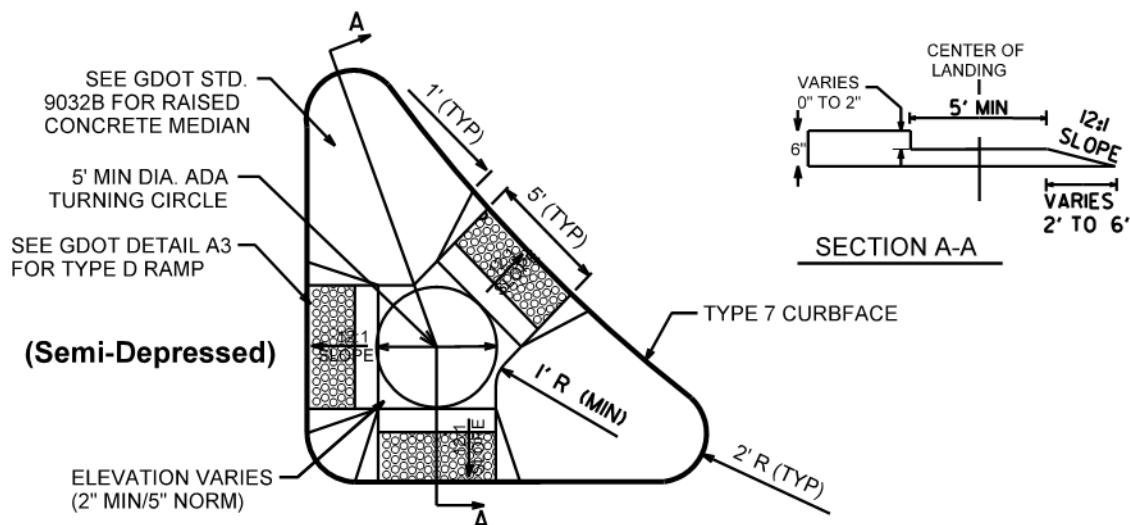

Figure 6.4b Raised Concrete Island with Ramps

6.10. Sidewalks

See **Section 9.5.1 Pedestrian Facility Design** for design criteria related to sidewalks.

6.11. Barriers

See **Section 5.4 Roadside Safety Hardware** for design criteria related to barriers.

6.12. Medians

GDOT has adopted the following “median usage” criteria as standard, having substantial importance to the operational and safety performance of a roadway such that special attention should be given to the design decision. **A decision to use a median dimension value that does not meet the standard criteria defined by GDOT shall require a comprehensive study by an engineer and the prior approval of a Design Variance from the GDOT Chief Engineer.**

The following factors should be considered when determining the applicable median dimension along a roadway:

- functional classification;
- context classification;
- access management plan;
- number of lanes;

- base year traffic;
- design year traffic;
- posted speed limit;
- design speed; and
- accident/crash data.

6.12.1. Freeway Medians

Freeways are required to have a depressed median or positive barrier separation in areas of restricted right-of-way restrictions, as specified in the AASHTO *Green Book*. For the Interstate System median width should meet criteria set by AASHTO's "A Policy on Design Standards - Interstate System." Positive barrier separation is required for all median widths \leq 52-ft or where mutually exclusive clear zone for each direction of traffic cannot be obtained. Positive barrier separation is not required for median widths $>$ 64-ft Median barrier is optional for median widths between 52-ft and 64-ft. Positive barrier separation should be considered for all existing medians where there is a history of cross median type crashes. All bridge columns should be protected regardless of median width.

6.12.2. Arterial Medians

Multi-lane roadways with design speeds \geq 50 mph shall require the positive separation of opposing traffic using a median.

Multi-lane roadways with three or more lanes in each direction shall include positive separation of opposing traffic using a median.

A 24-ft raised median will require a sloped curb (Type 7 curb-face) inside the median, and a 2-ft additional paved shoulder offset from the edge of the inside travel-lane to the edge of the gutter (for a total of 4-ft inside shoulder width from the edge of travel-lane to the face of the curb).

Raised medians shall be constructed on multi-lane roadways at intersections that exhibit one of the following characteristics:

- high turning volumes relating to 18,000 ADT (base year) and 24,000 ADT (design year);
- crash rate greater than the state average for its classification; and
- excessive queue lengths (as determined by District Traffic Engineer) in conjunction with excessive number of driveways.

Median options for arterial roadways (including GRIP Corridors) are described in Table 6.3.

Table 6.3. Median Options for Arterials (Including GRIP Corridors)

Median Width	ADT (Base Year)	ADT (Design Year)
Design Speeds ≤ 45 mph		
5-lane section (14-ft flush median)	≤ 18,000	≤ 24,000
5-lane section (14-ft flush median) ⁽¹⁾	≤ 18,000	> 24,000
20-ft or 24-ft raised median ⁽²⁾	> 18,000	> 24,000
Design Speeds ≤ 55 mph		
24-ft raised median	n/a	n/a
32-ft depressed median	n/a	n/a
44-ft depressed median	n/a	n/a
Design Speeds ≤ 65 mph		
44-ft depressed median	n/a	n/a
<p>⁽¹⁾ The project footprint should be designed and right-of-way purchased, to incorporate a future 20-ft raised median or preferably a 24-ft raised median where practical. The need to retrofit a flush median to a raised median section should be determined by the monitoring of accidents and traffic volumes on a five-year cycle by the Safety Engineer in the GDOT Office of Traffic Operations.</p> <p>⁽²⁾ GDOT prefers the use of a 24-ft raised median where practical.</p>		

6.12.2.1 Four Foot Wide Flush Medians⁴

In some cases, arterial widening projects have base and design year traffic volumes that are less than the 18,000 ADT and 24,000 ADT thresholds listed in the current policy. The projects may also be along sections of roadway with limited access points and a very low probability of future development. For example, areas where state right-of-way is parallel to agricultural operations or physical constraints such as a railroad or major utility, lakes, rivers, creeks, wetlands, steep slopes, and environmental resources.

Therefore, in an effort to provide additional design options for cases like this, the Department has decided to consider the use of 4-ft wide flush medians where it is practical to do so.

The factors the Department will use to consider the use of a 4 ft wide flush median is as follows:

- Base year traffic is less than 10,000 ADT;
- 24-hour truck percentage is less than 10%;
- Limited number of access points along the roadway. Depending on the access density, a traffic microsimulation model may be required to demonstrate that mainline volumes along with other selected design controls will not adversely affect acceptable gaps for uncontrolled left turning maneuvers;
- No obvious crash history directly related to left turns; and
- 4-ft median widths should not be used in combination with other minimum geometric design criteria. Therefore:

⁴[http://www.dot.ga.gov/PartnerSmart/DesignManuals/PolicyAnnouncements/4-ft%20Wide%20Flush%20Medians%20\(3-12-19\).pdf](http://www.dot.ga.gov/PartnerSmart/DesignManuals/PolicyAnnouncements/4-ft%20Wide%20Flush%20Medians%20(3-12-19).pdf)

- Horizontal and vertical alignments will meet current AASHTO Green Book criteria for 10 mph over the design speed.
- 12-ft wide travel lanes will be required.
- Shoulders widths will meet current AASHTO Green Book criteria.

Subsequent design elements required to use a 4-ft wide flush median are:

- Widening for left turn lanes will be required at intersections and major traffic generators; and,
- Centerline rumble strips and enhanced striping will be installed.

To ensure that appropriate studies and support is given to the decision, the approval of a Design Variance from the Department's Chief Engineer will be required before a 4-ft wide flush median design can advance to the final plan phase. The Design Variance must include the proposed typical section along with a plan & profile layout with curve data listed, and a traffic microsimulation model if required as noted in the criteria above.

Coordination with city and/or county planning and zoning officials should occur early in project development to determine the probability of development along project alignments. This coordination should support a decision to use a 4-ft wide flush median and should be noted in the Design Variance as rationale for the decision.

6.12.3. Medians at Pedestrian Crossings

Locations where a significant number of pedestrians are likely to cross the roadway at mid-block may warrant positive separation of opposing traffic using a median for pedestrian refuge. Signals are not typically warranted at these locations. Two-phase pedestrian crossings may be required when the roadway width requires excessive pedestrian crossing time (i.e., four-lane section with a TWLT lane, six-lane section, etc.). In the case of a two-phase pedestrian crossing, the median shall be wide enough to provide an ADA-compliant pedestrian refuge area. Refer to **Section 4.3.7** of the GDOT [Pedestrian and Streetscape Guide](#)⁵ for information related to median refuge island design. See Section 9.5.1 Pedestrian Accommodation Design under Mid-block Crossings of this manual for further information also, refer to **Section R305.2.4 Pedestrian Refuge Islands** of the [PROWAG](#)⁶.

6.13. Parking Lanes

Generally, parking on arterial highways is prohibited because on-street parking decreases through capacity, impedes traffic flow, and increases accident potential. At the request of the local governing authority, consideration may be given to the inclusion of parking adjacent to the roadway in special situations if the following conditions are met:

- parking currently exists adjacent to the roadway;
- adequate off-street parking facilities are unavailable or unfeasible;

⁵<http://www.dot.ga.gov/PartnerSmart/DesignManuals/TrafficOps/GDOT%20Pedestrian%20and%20Streetscape%20Guide.pdf>

⁶ <https://www.access-board.gov/attachments/article/743/nprm.pdf>

- the subsequent reduction in highway capacity will be insignificant; and
- the local governing authority has agreed to pay for the additional costs associated with the on-street parking, such as additional right-of-way, construction costs, etc.

When on-street parking is allowed on a roadway, parallel parking or back-in angle parking (sometimes termed “reverse-angle” parking) are the preferred types. Under certain circumstances, conventional angled parking is allowed. However, conventional angled parking presents sight distance problems due to the varying length of vehicles, such as vans and recreational vehicles. The extra length of these vehicles may also interfere with the traveled way. Back-in angle parking provides a better view of bicyclist, pedestrians and motorized vehicles when exiting the parking space and entering the travel lane. The type of on-street parking selected should depend on the specific function and width of the street, adjacent land uses and traffic volume.

6.14. Noise Barriers

Noise barriers may be installed along roadways to mitigate the effects of roadway noise levels. Noise barriers are commonly structures referred to as noise walls, but may also be earthen berms or a combination berm/wall system. A noise barrier, or noise wall, is normally located either at the edge of the roadway or very near the right-of-way line and may be mounted on the ground, on concrete barriers, on retaining walls, or on bridge barriers.

6.14.1. The Environmental Process

The decision to add a noise barrier to a project is part of the environmental process documented in a noise study. This study is prepared for all federal-aid projects which construct a new roadway or alter the existing roadway that either significantly changes the roadway alignment or increases the number of through lanes. The study can be prepared as soon as the vertical and horizontal alignments of a project have been established which normally occurs during early preliminary design.

Further information on GDOT’s noise assessment and abatement policy can be found in GDOT **Policy 4415-11, Highway Noise Abatement Policy for Federal-Aid Projects** and Chapter 5, **Section 6.1, Noise Assessment** of the GDOT Environmental Procedures Manual.

Where a noise barrier is warranted, the noise study will include the following information:

- sources of noise;
- noise receptor locations;
- estimated level of noise reduction;
- locations of existing and future noise impacts along the roadway corridor; and
- recommendations regarding barrier location, height, and length.

The noise assessment process includes public outreach where those benefited by the noise barrier can complete a comment card and express comments on the wall finish (brick stamp, ashlar, or textured). Public outreach normally occurs during final design and documented in the environmental reevaluation completed for letting, following Final Field Plan Review. The Office of Environmental Services Air/Noise Unit will provide the results of this public outreach to the project manager and design phase leader.

After the noise report is complete, any significant changes to the dimensions or locations of a noise barrier must be reviewed by the Office of Environmental Services to evaluate the impact of the changes on noise abatement.

6.14.2. Design of Noise Walls

The following guidelines should be considered when designing a noise wall. Further information regarding the design of noise walls can be found in the FHWA publication, [Highway Noise Barrier Design Handbook](#).

Material Type

Noise walls shall be constructed using precast concrete panels. Interlocking steel panels shall be used only where a lighter weight material is necessary such as on bridges and retaining walls. Timber, transparent or absorptive panels may be specified only to address context sensitive or special design needs, as defined in the project noise study. A decision to use a noise wall material other than precast concrete panels or interlocking steel panels, as noted above, will require written approval from the GDOT Chief Engineer. The approval request will contain the project description, an explanation of why a different material has been selected, and an “approval” line for the Chief Engineer’s signature. The request will be submitted to DesignException@dot.ga.gov for processing.

Horizontal Alignment

- Where practical, noise walls should be placed as far from travel lanes as practical. The most desirable locations are just inside the right-of-way or outside the clear zone. Noise walls located within the clear zone should be shielded with an appropriate roadside barrier. Safety, maintenance, aesthetics, cost, and noise attenuation should also be considered when defining wall locations.
- Noise walls should be located to take advantage of terrain with higher elevation, if possible. In a roadway cut area, a wall located along the right-of-way will often result in a lower wall height than where located along the shoulder. Conversely, in a roadway fill area, a wall located along the shoulder will often result in the lower wall height.
- Where construction does not significantly increase cost, noise walls should also serve as limited access barriers in place of right-of-way fencing. When taking the place of a right-of-way fence, a wall must be at least 6-ft in height. A noise wall must be offset a minimum of 5 ft inside the right-of-way line, to ensure there is adequate space for installation and maintenance.
- Where located at the edge of the roadway shoulder (common in fill sections), the noise wall will be either mounted on or behind a concrete barrier or side barrier, or be mounted on a bridge barrier (as applicable). The normal paved shoulder width should be increased by 2 ft.
- The noise wall should extend past the end receiver at least four times the perpendicular distance from the receiver to the noise wall. This distance may be shortened by bending the wall back toward the receiver.

- Stopping sight distance along the roadway must be provided along the entire length of the noise wall. This is of particular concern for noise wall segments located along the inside of horizontal curves at the edge of the roadway shoulder, and where a noise wall terminates at a ramp intersection or intersection with another roadway.
- Where a gap in a noise wall is necessary, such as when providing an opening for vehicular access or a drainage ditch, the two wall segments should be overlapped. The ratio between the overlap distance and gap width (between walls) should be at least 4:1 to maintain the integrity of the noise mitigation.

Vertical Profile

- Noise walls should have a minimum height of 6 ft. References to height should be with respect to the center of the nearest travel lane or other construction baseline.
- The height of noise wall should be no greater than 30 ft.

Access

- Access to the back side of the noise wall must be provided if the area behind the noise wall is to be maintained by the GDOT. Access will normally be provided by a door in the wall. The design phase leader must coordinate the final location and type of access with the GDOT District Maintenance office and show these locations on construction plans.
- Access will commonly be provided using double steel fire doors (for access by personnel and equipment). It is preferable to locate the door on a segment of the noise wall that is away from the roadway shoulder. Where equipment access is not necessary, a single door is sufficient (for access by personnel). Doors are normally spaced at a maximum interval of 1,000 ft. The height of the wall should be at least 10 feet at door locations.
- A single door should also be placed within 200 ft of one end of each bridge and bridge culvert, on both sides of the road.
- If requested by a local emergency response agency, small openings may also be provided in the noise barrier which allows a fire hose to be passed through the wall.

Structural

- The height of a noise wall mounted on a bridge barrier should be no greater than 12 ft from the top of the bridge deck to the top of the noise wall, unless otherwise approved by the GDOT Office of Bridge Design.
- On bridge barriers and on retaining walls, interlocking steel panels should be used. The use of other materials will require concurrence from the GDOT Office of Bridge Design prior to requesting approval from the Chief Engineer (refer to Section 6.14.2).
- Noise walls are only attached to concrete barriers and retaining walls that have been specifically designed for the loading from the noise wall. Refer to Georgia Construction Detail N-1B.

Drainage

- Drainage for noise walls located at the edge of the roadway shoulder can be addressed in a similar manner as for a side barrier located at the edge of the roadway shoulder.
- For noise walls offset from the roadway shoulder, surface ditches running along the wall with associated culverts or inlets should be provided to ensure that runoff does not “pond” behind the wall.
- Where runoff from an adjacent area sheet flows toward the wall, small unshielded ground level openings in the wall can be provided. The following sizes are allowed: (1) openings of 8-in. by 8-in. or smaller spaced no closer than 10-ft on center; and (2) openings of 8-in. by 16-in. or smaller spaced no closer than 20-ft on center, and the nearest noise receiver is at least 10-ft from the nearest opening. The actual location and spacing of these openings must be designed to ensure that runoff does not “pond” behind the wall.
- A trench drain with outlet pipes running underneath the wall, or a porous stone trench beneath the wall can be considered. A disadvantage of this system is that maintenance is required to ensure that the drainage stone does not clog up over time with sediment.

Other Considerations

- The locations of sign and sign structures may require special coordination for noise walls located at the edge of the roadway shoulder. Small signs can often be mounted on the noise wall posts. Sign support structures can be accommodated by a jog in the noise wall that allows for installation of the structure in front of the wall. In this case, the sign support structure will need to be protected with a guardrail.
- The project soil survey should include an investigation to identify the elevation of rock along the noise wall alignment. A spread footing will be used when a drilled shaft foundation is not feasible due to shallow rock. Refer to Georgia Construction Detail N-3.
- Ensure that adequate horizontal and vertical clearances are provided for underground and above ground utilities. Underground utilities may require the use of spread footings in place of drilled shafts (or posts). Overhead utilities may preclude the use of full-height precast panels, which are often installed using a crane or lift.

6.14.3. Construction Plan Requirements

Construction plan requirements are presented in the [GDOT Plan Presentation Guide](#). Noise wall envelopes must be provided for all projects. Normally, separate noise wall plan sheets are only required for stand-alone noise wall projects. The noise wall envelope should reflect minimum height requirements (i.e., a smooth profile). Actual construction will be performed using shop drawings provided by the contractor and approved by the GDOT Office of Bridge Design.

The design phase leader must note the material type for noise walls on the construction plan wall envelopes and on the noise wall plans, if applicable, and will include the pay item for the noise wall type in the project’s CES Cost Estimate. If the noise wall type is a material other than concrete or steel as defined in Section 6.14.2, approval from the Chief Engineer must first be obtained.

[Georgia Construction Details](#) are available for noise walls; appropriate sheets should be included in project construction plans. Refer also to GDOT Specification 624, Noise Barriers. Where a material other than concrete has been approved, please contact StandardsAndDetails@dot.ga.gov to request copies of construction details which may apply. Details are available for N-6 Type F- Glass Reinforced Thermo Composite Panels Filled with Recycled Tire Rubber and N-7 Type G- Precast Autoclaved Aerated Concrete Panels, etc. A copy of the Chief Engineer's approval must be attached to the request.

6.14.4. Construction

All noise walls must be designed in accordance with the Bridge Design Manual.

A list of prequalified noise wall systems is provided on the Department's Qualified Products List *QPL-90, Noise Barrier Walls*. Shop drawings must be submitted for review and approval by GDOT Office of Bridge Design.

6.15. Summary of Design Criteria for Cross Section Elements

GDOT has developed the following tables to summarize the criteria used to design typical cross section elements for roadway classifications in Georgia with Average Daily Traffic greater than 2000 vehicles per day. The criteria listed within the tables represent typical geometric dimensions used to design common rural and urban type roadways according to the selected design speed. The tables are for reference only and do not reflect every possible design option available to the designer. Drawings of commonly used typical sections are also provided to illustrate the application of the criteria listed in the tables. The designer is encouraged to select design criteria that provide a balance among the design vehicle, other users of the facility, and within the context of the surrounding environment.

- **Table 6.4.** Design Criteria for Local Roadways
- **Table 6.5.** Design Criteria for Collector Roadways
- **Table 6.6.** Design Criteria for Arterial Roadways
- **Table 6.7.** Design Criteria for Freeways

Table 6.4. Design Criteria for Local Roadways

Cross Section Element	Rural (open ditch sections) (ADT > 2000) ⁽¹⁾			Urban (curbed sections) (ADT > 2000) ⁽¹⁾	
	2-Lane			2-Lane	
	35 mph	45 mph	55 mph	25 mph	35 mph
Desirable Level of Service (LOS) ⁽²⁾	C or D	C or D	C or D	C or D	C or D
Traveled – Way					
Lane width (min-desirable)	11-12-ft	11-12-ft	11-12-ft	10-12-ft	10-12-ft
Cross slope (normal)	2%	2%	2%	2%	2%
Superelevation (max)	6% or 8%	6% or 8%	6% or 8%	4%	4%
Shoulders					
Overall width	6-ft/8-ft	6-ft/8-ft	6-ft/8-ft	n/a	n/a
Paved width	2-ft	2-ft	2-ft	n/a	n/a
Cross slope (normal)	6%	6%	6%	n/a	n/a
Border Area (urban shoulder) (width)	n/a	n/a	n/a	10-16-ft	10-16-ft
Cross slope (normal)	n/a	n/a	n/a	2%	2%
Sidewalk (SW)					
Width of Sidewalk	n/a	n/a	n/a	5-ft	5-ft
Desirable buffer from back of curb to SW	n/a	n/a	n/a	6-ft	6-ft
Cross slope (max)	n/a	n/a	n/a	2%	2%
Width of Bike Lanes	4-ft ⁽³⁾	4-ft ⁽³⁾	4-ft ⁽³⁾	4-5-ft ⁽⁴⁾	4-5-ft ⁽⁴⁾
Foreslope (max/normal) ⁽⁵⁾	2:1/4:1	2:1/4:1	2:1/4:1	2:1/4:1	2:1/4:1
Width of foreslope in cut	10-ft	12-ft	12-ft	n/a	n/a
Ditch Bottom (width)	4-ft	4-ft	4-ft	n/a	n/a
Backslope (max/normal) ⁽⁵⁾	2:1/4:1	2:1/4:1	2:1/4:1	2:1/4:1	2:1/4:1
Vertical Clearance (min-desirable) ⁽⁶⁾ (ft)	14.5-16.75	14.5-16.75	14.5-16.75	14.5-16.75	14.5-16.75
Lateral Offset to Obstruction ⁽⁷⁾	Ch. 5	Ch. 5	Ch. 5	Ch. 5	Ch. 5
Clear Zone ⁽⁹⁾	18-ft	24-ft	26-ft	AASHTO	AASHTO
Notes:					
(1) Values shown are for roadways with ADT > 2000. Refer to the current AASHTO Green Book for design criteria on major collectors with ADT ≤ 2000, and the AASHTO "Guidelines for Geometric Design of Low-Volume Roads, 2 nd Ed." for design criteria on local and minor collectors with ADT ≤ 2,000.					
(2) LOS D is appropriate in heavily developed urban or suburban areas.					
(3) Bike Lane is incorporated into the overall width of a 6.5-ft paved shoulder to include a rumble strip and buffer area (refer to Ga. Construction Detail T-25). See Section 9.4.2 Bicycle Warrants .					
(4) Bike Lane measured from the outside edge of traveled-way outward. The 4-ft dimension does not include curb & gutter or header curb. The 5-ft dimension is required when adjacent to a header curb, guardrail, or other vertical surface. A 6-ft width should be used adjacent to a concrete barrier, where practical.					
(5) The use of a slope inside the "Clear Zone" that is steeper than 4:1 will require the installation of a roadside barrier (i.e. guardrail, barrier wall, crash attenuator, etc.). (See Ga.Std.Details, 4000 series).					
(6) 14.5-ft is permissible, provided a suitable bypass exists for tall vehicles. For additional guidelines, refer to Chapter 2.3 of the GDOT Bridge and Structures Policy Manual. http://www.dot.ga.gov/PartnerSmart/DesignManuals/BridgeandStructure/GDOT_Bridge_and_Structures_Policy_Manual.pdf					
(7) For rural roadways, lateral offset is measured from the edge of traveled way outward. For urban roadways with curbed sections, lateral offset is measured from the face of curb outward. See Chapter 5 of this Manual for GDOT guidelines on lateral offset to signs, light poles, utility installations, signal poles and hardware, and trees and shrubs.					
(8) AASHTO defines Clear Zone as the unobstructed relatively flat area beyond the edge of traveled way for the recovery of errant vehicles. Clear Zone recommendations are a function of design speed, traffic volumes, and embankment slope. For Clear Zone recommendations, refer to the current edition of the AASHTO Roadside Design Guide, Ch. 3.					

Table 6.5. Design Criteria for Collector Roadways					
Cross Section Element	Rural (open ditch sections) (ADT > 2000) ⁽¹⁾		Urban (curbed sections) (ADT > 2000) ⁽¹⁾		
	2-Lane	4-Lane	2-Lane	4-Lane	
Design Speed	45 mph	55 mph	25 mph	35 mph	45 mph
Desirable Level of Service (LOS)	C	C	C or D ⁽²⁾	C or D ⁽²⁾	C or D ⁽²⁾
Traveled – Way					
Lane width (min-desirable)	11-12-ft	11-12-ft	11-12-ft	11-12-ft	11-12-ft
Cross slope (normal)	2%	2%	2%	2%	2%
Superelevation (max)	6% or 8%	6% or 8%	4%	4%	4%
Shoulders (outside)					
Overall width	6-ft/8-ft	10-ft	n/a	n/a	n/a
Paved width	4-ft/6.5-ft ⁽³⁾	6.5-ft	n/a	n/a	n/a
Cross slope (normal)	6%	6%	n/a	n/a	n/a
Shoulders (median)					
Overall width	n/a	6-ft	n/a	n/a	n/a
Paved width	n/a	2-ft	n/a	n/a	n/a
Cross slope (normal)	n/a	4%	n/a	4%	4%
Border Area (urban shoulder) (width)	n/a	n/a	10 -16-ft	10 -16-ft	10 -16-ft
Cross slope (normal)	n/a	n/a	2%	2%	2%
Width of Median					
Depressed	n/a	32 - 44-ft	n/a	n/a	n/a
Raised	n/a	24-ft	n/a	20-ft	20-ft
Flush	n/a	n/a	n/a	14-ft	14-ft
Sidewalk (SW)					
Width of sidewalk	n/a	n/a	5-ft	5-ft	5-ft
Desirable buffer from back of curb to SW	n/a	n/a	6-ft	6-ft	6-ft
Cross slope (max)	n/a	n/a	2%	2%	2%
Width of Bike Lanes	4-ft ⁽³⁾	4-ft ⁽³⁾	4-5-ft ⁽⁴⁾	4-5-ft ⁽⁴⁾	4-5-ft ⁽⁴⁾
Foreslope (max/normal)⁽⁵⁾	2:1/4:1	2:1/4:1	2:1/4:1	2:1/4:1	2:1/4:1
Width of foreslope in cut	12-ft	12-ft	n/a	n/a	n/a
Ditch Bottom (width)	4-ft	4-ft	n/a	n/a	n/a
Backslope (max/normal)⁽⁵⁾	2:1/4:1	2:1/4:1	2:1/4:1	2:1/4:1	2:1/4:1
Vertical Clearance (min-desirable)⁽⁶⁾(ft)	16.5 -16.75	16.5 -16.75	16.5-16.75	16.5 -16.75	16.5 -16.75
Lateral Offset to Obstruction⁽⁷⁾	Ch. 5	Ch. 5	Ch. 5	Ch. 5	Ch. 5
Clear Zone⁽⁸⁾	24-ft	26-ft	AASHTO	AASHTO	AASHTO
Notes:					
(1) Values shown are for roadways with ADT > 2000. Refer to the current AASHTO Green Book for design criteria on major collectors with ADT ≤ 2000, and the AASHTO "Guidelines for Geometric Design of Low-Volume Roads, 2 nd Ed " for design criteria on local and minor collectors with ADT ≤ 2000.					
(2) LOS D is appropriate in heavily developed urban and suburban areas.					
(3) Bike Lane is incorporated into the overall width of a 6.5-ft paved shoulder to include a rumble strip and buffer area (refer to Ga. Construction Detail T-25). See Section 9.4.2 Bicycle Warrants .					
(4) Bike Lane measured from the outside edge of traveled-way outward. The 4-ft dimension does not include curb & gutter or header curb. The 5-ft dimension is required when adjacent to a header curb, guardrail, or other vertical surface. A 6-ft width should be used adjacent to a concrete barrier, where practical.					
(5) The use of a slope inside the "Clear Zone" that is steeper than 4:1 will require the installation of a roadside barrier (i.e. guardrail, barrier wall, crash attenuator, etc.). (See Ga.Std.Details, 4000 series).					
(6) For additional guidelines, refer to Chapter 2.3 of the GDOT Bridge and Structures Policy Manual.					
(7) For rural roadways, lateral offset is measured from the edge of traveled way outward. For urban roadways with curbed sections, lateral offset is measured from the face of curb outward. See Chapter 5 of this Manual for GDOT standard criteria for lateral offset to signs, light poles, utility installations, signal poles and hardware, and trees and shrubs.					
(8) AASHTO defines Clear Zone as the unobstructed, relatively flat area beyond the edge of traveled way for the recovery of errant vehicles. Clear Zone recommendations are a function of design speed, traffic volumes, and embankment slope. For Clear Zone recommendations, refer to the current edition of the AASHTO Roadside Design Guide, Ch. 3.					

Table 6.6. Design Criteria for Arterial Roadways

Cross Section Element	Rural (open ditch sections)				Urban (curbed sections)	
	2-Lane	2-Lane	4-Lane	4-Lane	4-Lane	4-Lane
Design Speed	45 mph	55 mph	55 mph	65 mph	45 mph	55 mph
Desirable Level of Service (LOS)	B	B	B	B	C or D ⁽¹⁾	C or D ⁽¹⁾
Traveled – Way						
Lane width (min-desirable) ⁽²⁾	11-12-ft	11-12-ft	11-12-ft	11-12-ft	11-12-ft	11-12-ft
Cross slope (normal)	2%	2%	2%	2%	2%	2%
Superelevation (max)	6% or 8%	6% or 8%	6% or 8%	6% or 8%	4%	4%
Shoulders (outside)						
Overall width	8-ft	10-ft	10-ft	10-ft	n/a	n/a
Paved width	4-ft /6.5-ft ⁽³⁾	4-ft /6.5-ft ⁽³⁾	6.5-ft	6.5-ft	n/a	n/a
Cross slope (normal)	6%	6%	6%	6%	n/a	n/a
Shoulders (median)						
Overall width (cross slope)	n/a	n/a	6-ft (4%)	6-ft (4%)	n/a	n/a
Paved width (cross slope with mainline)	n/a	n/a	2-ft (2%)	2-ft (2%)	n/a	2-ft
Border Area (urban shoulder) (width)	n/a	n/a	n/a	n/a	10 -16-ft	10 -16-ft
Cross slope (max)	n/a	n/a	n/a	n/a	2%	2%
Width of Median						
Depressed	n/a	n/a	32 - 44-ft	44-ft	n/a	n/a
Raised	n/a	n/a	24-ft	n/a	20-ft	24-ft
Flush	n/a	n/a	n/a	n/a	14-ft	n/a
Sidewalk (SW)						
Width of sidewalk	n/a	n/a	n/a	n/a	5-ft	5-ft
Desirable buffer from back of curb to SW	n/a	n/a	n/a	n/a	6-ft	6-ft
Cross slope (max)	n/a	n/a	n/a	n/a	2%	2%
Width of Bike Lanes	4-ft ⁽³⁾	4-ft ⁽³⁾	4-ft ⁽³⁾	4-ft ⁽³⁾	4-5-ft ⁽⁴⁾	4-5-ft ⁽⁴⁾
Foreslope (max/normal)⁽⁵⁾	2:1/4:1	2:1/4:1	2:1/4:1	2:1/6:1	2:1/4:1	2:1/4:1
Width of foreslope in cut	12-ft	12-ft	12-ft	18-ft	n/a	n/a
Ditch Bottom (width)	4-ft	4-ft	4-ft	4-ft	n/a	n/a
Backslope (max/normal)⁽⁵⁾	2:1/4:1	2:1/4:1	2:1/4:1	2:1/6:1	2:1/4:1	2:1/4:1
Vertical Clearance (min-desirable)⁽⁶⁾(ft)	16.5-16.75	16.5-16.75	16.5-16.75	16.5-16.75	16.5-16.75	16.5-16.75
Lateral Offset to Obstruction⁽⁷⁾	Ch. 5	Ch. 5	Ch. 5	Ch. 5	Ch. 5	Ch. 5
Clear Zone⁽⁸⁾	24-ft	26-ft	26-ft	32-ft	AASHTO	AASHTO

Notes:

- (1) LOS D is appropriate in heavily developed urban and suburban areas.
- (2) See AASHTO Green Book, Chapter 7, Rural and Urban Arterials, for conditions to construct or retain 11-ft lanes.
- (3) Bike Lane is incorporated into the overall width of a 6.5-ft paved shoulder to include a rumble strip and buffer area (refer to Ga. Construction Detail T-25). See **Section 9.4.2 Bicycle Warrants**.
- (4) Bike Lane measured from the outside edge of traveled-way outward. The 4-ft dimension does not include curb & gutter or header curb. The 5-ft dimension is required when adjacent to a header curb, guardrail, or other vertical surface. A 6-ft width should be used adjacent to a concrete barrier, where practical.
- (5) The use of a slope inside the "Clear Zone" that is steeper than 4:1 will require the installation of a roadside barrier (i.e. guardrail, barrier wall, crash attenuator, etc.). (See Ga.Std.Details, 4000 series).
- (6) For additional guidelines, refer to Chapter 2.3 of the GDOT Bridge and Structures Policy Manual.
- (7) For rural roadways, lateral offset is measured from the edge of traveled way outward. For urban roadways with curbed sections, lateral offset is measured from the face of curb outward. See Chapter 5 of this Manual for GDOT standard criteria for lateral offset to signs, light poles, utility installations, signal poles and hardware, and trees and shrubs.
- (8) AASHTO defines Clear Zone as the unobstructed, relatively flat area beyond the edge of traveled way for the recovery of errant vehicles. Clear Zone recommendations are a function of design speed, traffic volumes, and embankment slope. For Clear Zone recommendations, refer to the current edition of the AASHTO Roadside Design Guide, Ch. 3.

Table 6.7. Design Criteria for Freeways

Cross Section Element	Rural (graded shoulders and ditches) (ADT > 6000)	Urban (depressed/restricted R/W) (ADT > 6000)	
	4 – 6 Lane	4 – 6 Lane	
Design Speed	70 mph	55 mph	65 mph
Desirable Level of Service (LOS)	B or C ⁽¹⁾	C or D ⁽²⁾	C or D ⁽²⁾
Traveled – Way			
Lane width	12-ft	12-ft	12-ft
Cross slope (normal)	2%	2%	2%
Superelevation (maximum)	8%	6%	6%
Shoulders (outside)			
Overall width	14-ft	14-ft	14-ft
Paved width	12-ft	12-ft	12-ft
Shoulders (median)			
Overall width	12-ft	12-ft	12-ft
Paved width	10-ft ⁽³⁾	10-ft ⁽³⁾	10-ft ⁽³⁾
Width of Median			
Depressed	52-64-ft	n/a	n/a
Continuous barrier (6-lanes)	n/a	30 – 40-ft	30 – 40-ft
Continuous barrier (8-lanes)	n/a	28 – 30-ft	28 – 30-ft
Foreslope (max/normal)⁽⁴⁾	2:1/6:1	2:1/6:1	2:1/6:1
Width of foreslope in cut	18-ft	n/a	n/a
Ditch Bottom (width)	4-ft	n/a	n/a
Backslope (max/normal)⁽⁴⁾	2:1/4:1	2:1/4:1	2:1/4:1
Vertical Clearance (min-desirable)⁽⁵⁾(ft)	16.5-17	16.5-17	16.5-17
Lateral Offset to Obstruction⁽⁶⁾	Ch. 5	Ch. 5	Ch. 5
Clear Zone⁽⁷⁾	36-ft	AASHTO	AASHTO
Note: (1) LOS C is appropriate for developing rural and suburban areas and for auxiliary lanes. (2) LOS D is appropriate in heavily developed urban areas. (3) A 12-ft wide paved inside shoulder should be used on Freeways with six or more lanes, and truck volumes greater than 250 vehicles/hour. (4) The use of a slope inside the "Clear Zone" that is steeper than 4:1 will require the installation of a roadside barrier (i.e. guardrail, barrier wall, crash attenuator, etc.). (See Ga.Std.Details, 4000 series). (5) For additional guidelines, refer to Chapter 2.3.2 of the GDOT Bridge and Structures Policy Manual. (6) For Freeways, lateral offset is measured from the edge of traveled way outward. See Chapter 5 of this Manual for GDOT standard criteria for lateral offset to signs, light poles, utility installations, signal poles and hardware, and trees and shrubs. (7) AASHTO defines Clear Zone as the unobstructed, relatively flat area beyond the edge of traveled way for the recovery of errant vehicles. Clear Zone recommendations are a function of design speed, traffic volumes, and embankment slope. For Clear Zone recommendations, refer to the current edition of the AASHTO Roadside Design Guide, Ch. 3.			

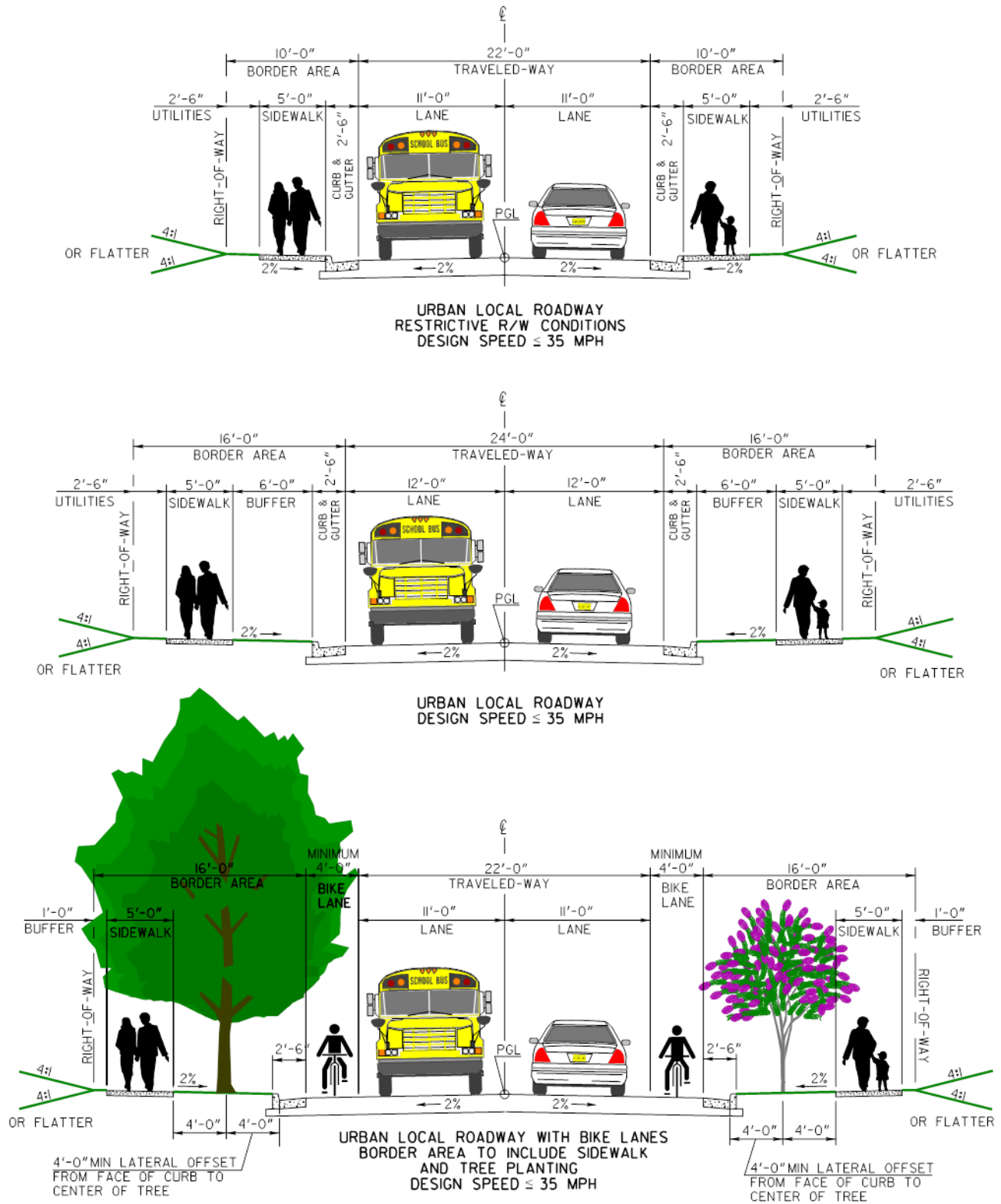

Figure 6.5. Illustration of Typical Dimensions for Urban Local Roadways

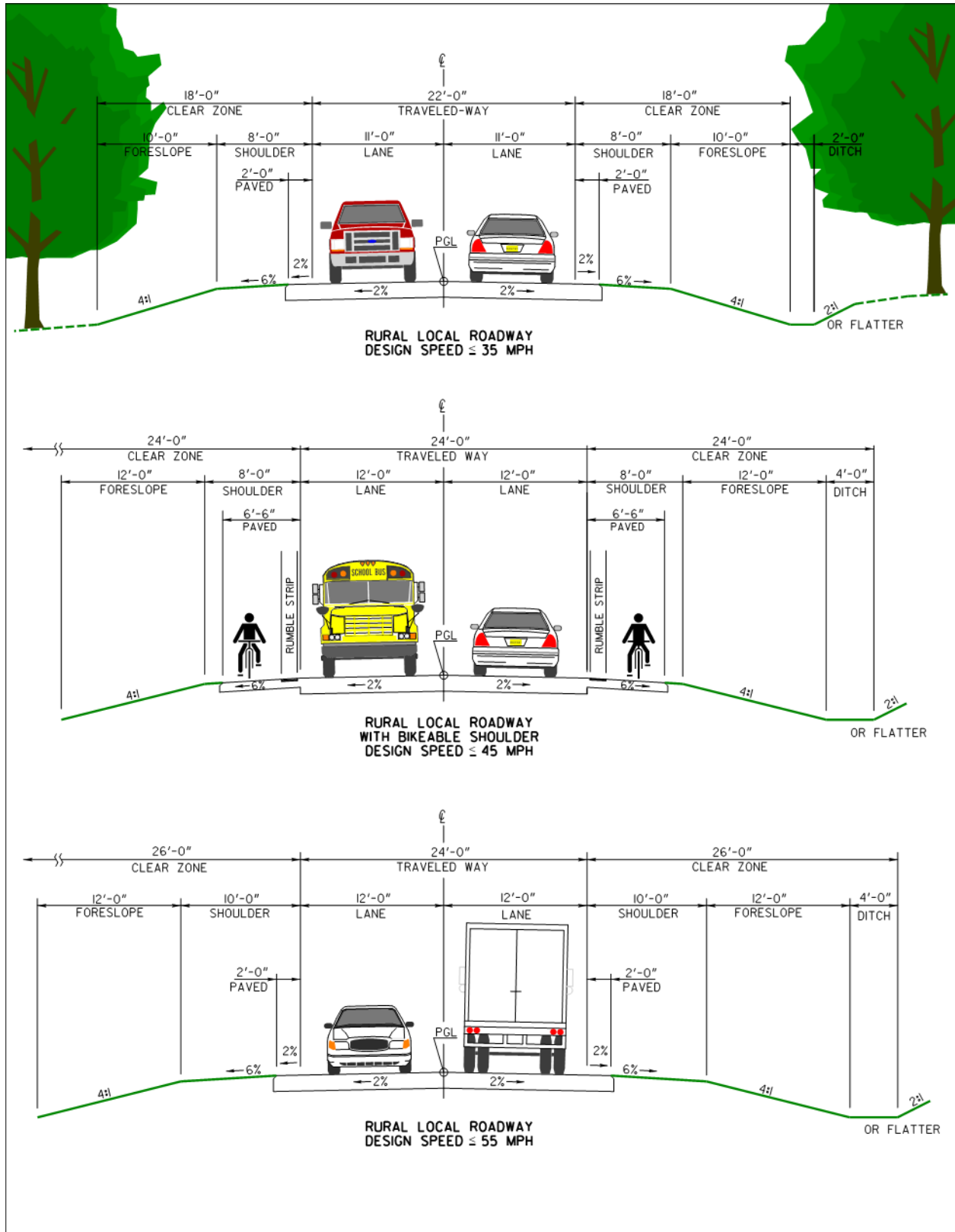

Figure 6.6. Illustration of Typical Dimensions for Rural Local Roadways

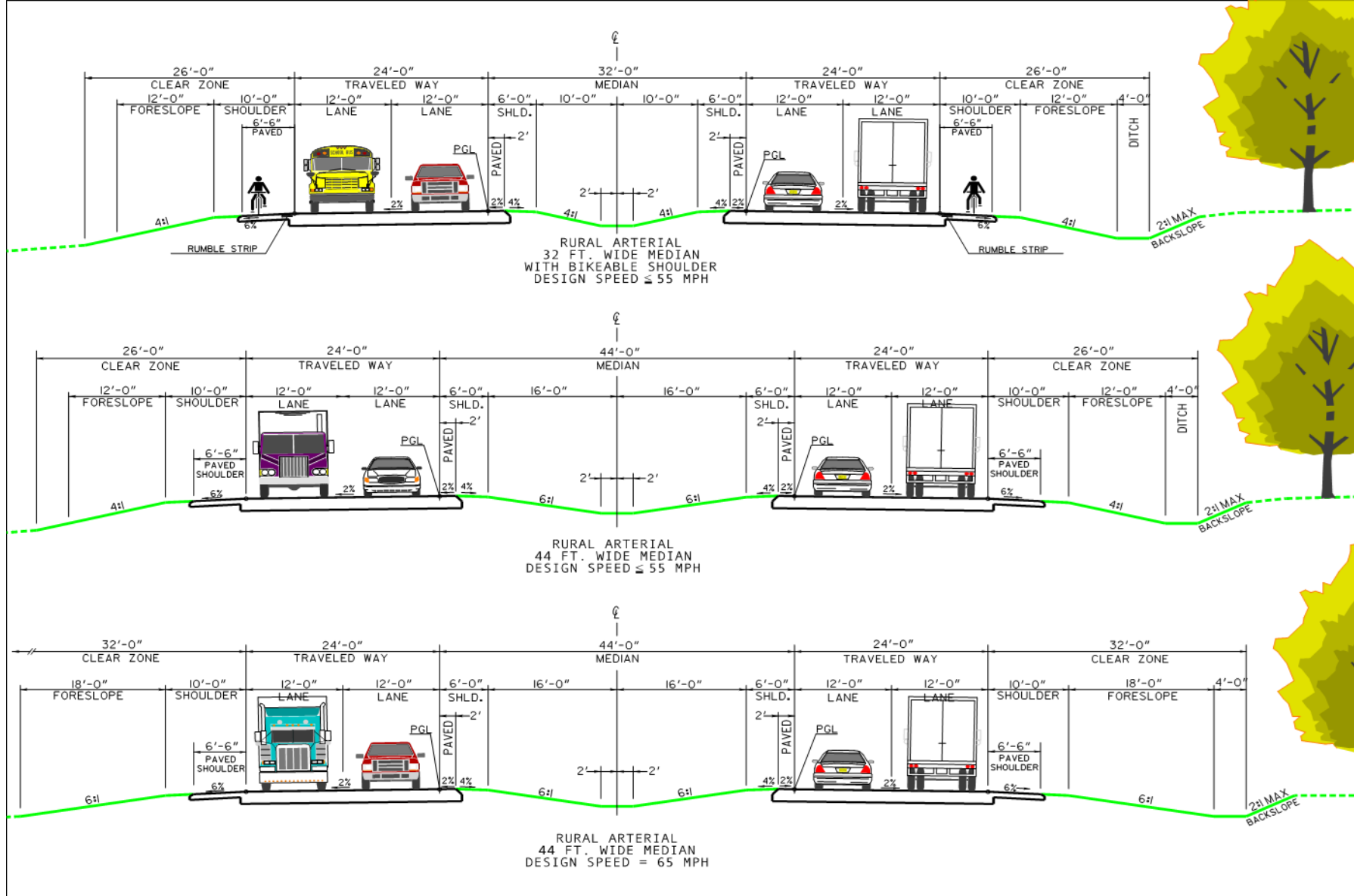

Figure 6.7. Illustration of Typical Dimensions for Collector and Arterial Roadways

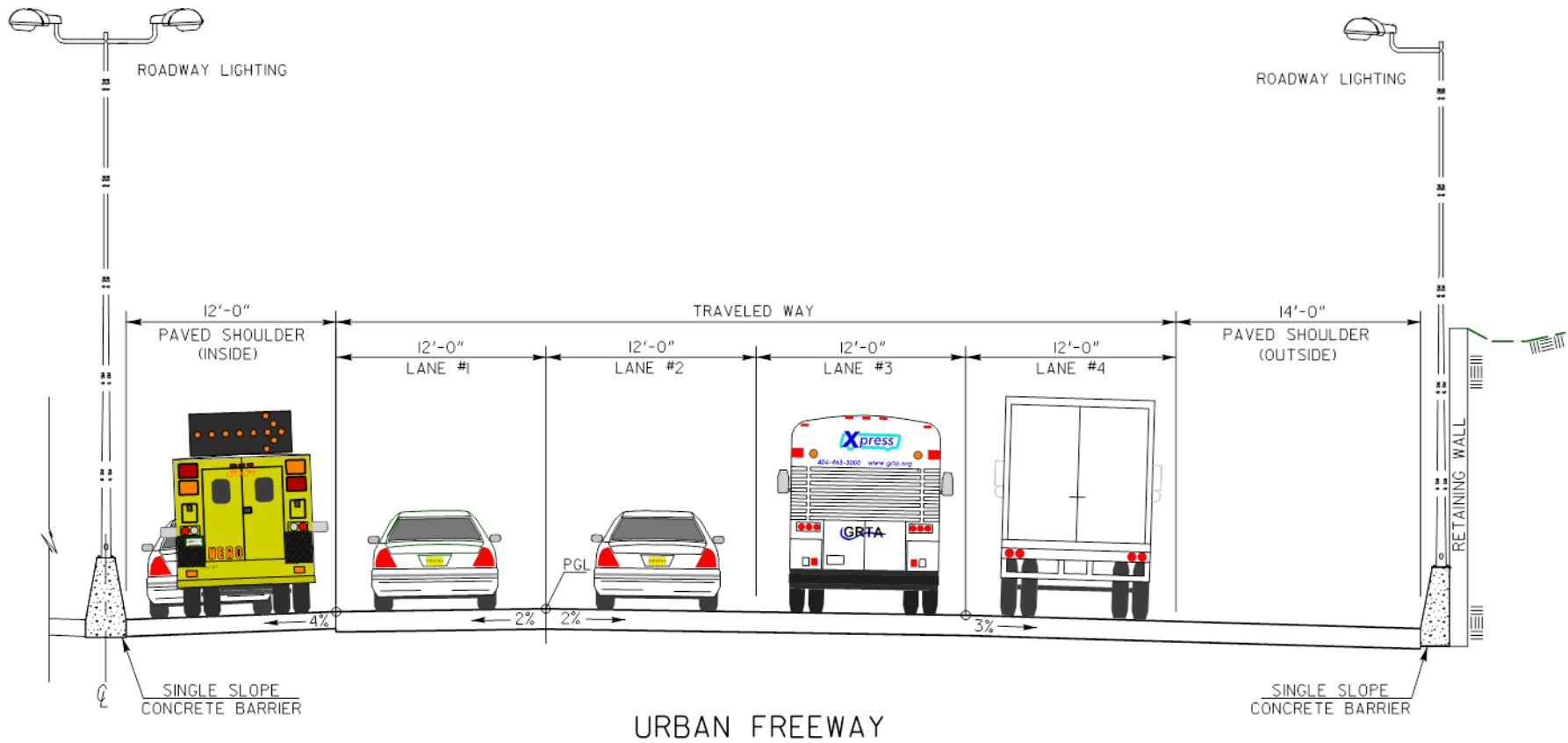

Figure 6.8. Illustration of Typical Dimensions for Urban Freeway

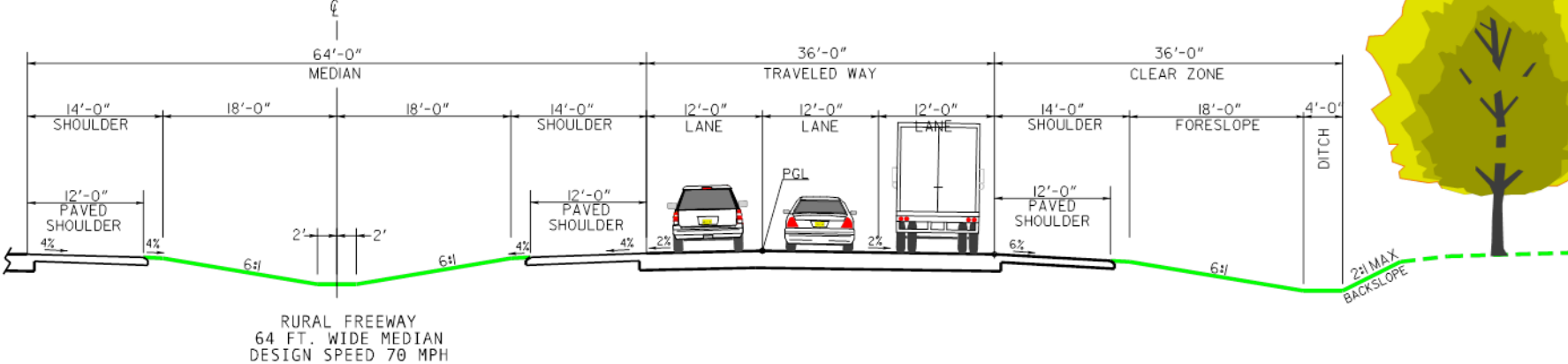

Figure 6.9. Illustration of Typical Dimensions for Rural Freeway

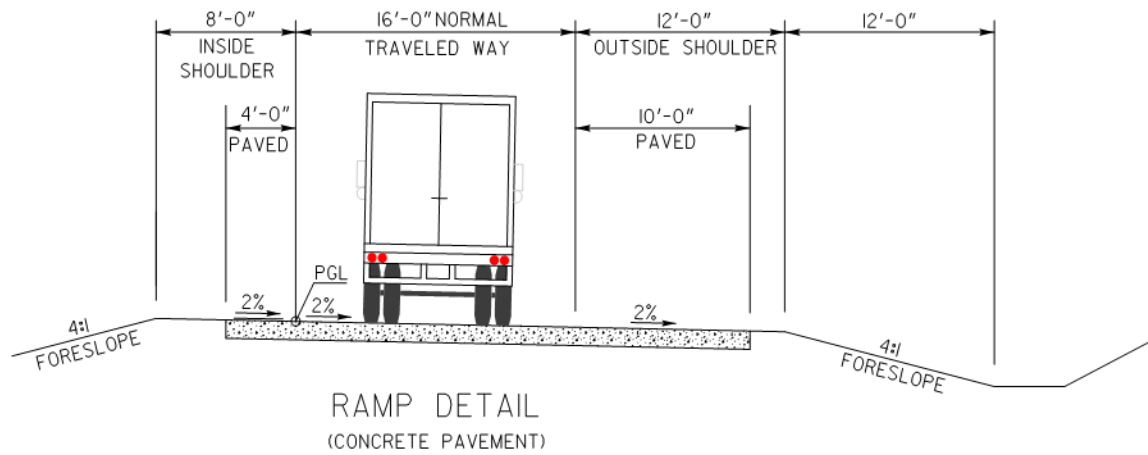
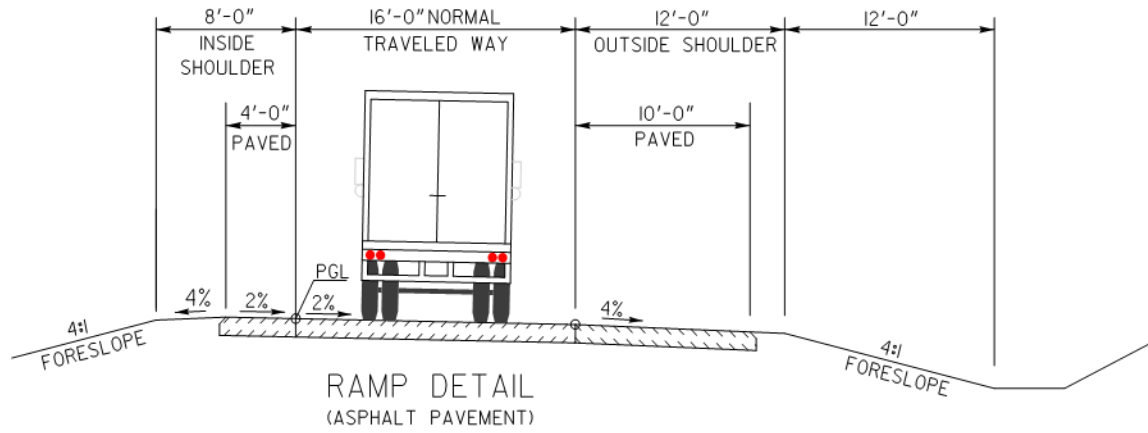

Figure 6.10. Illustration of Typical Dimensions for Interchange Ramps

Intentionally Left Blank

Chapter 7. AT Grade Intersections - Contents

Chapter 7. AT Grade Intersections - Contents.....	7-i
7.1. Intersection Design Elements.....	7-1
7.2. Intersection Geometrics.....	7-1
7.2.1. Angle of Intersection/Skew Angle.....	7-1
7.2.2. Right-of-Way Flares	7-1
7.2.3. Turn Lanes	7-2
7.2.4. Islands	7-2
7.2.5. Intersection Radii.....	7-3
7.3. Median Openings	7-3
7.4. Driveways	7-4
7.5. Signalization	7-5
7.5.1. New Intersections and Existing Unsignalized intersections.....	7-6
7.5.2. Signal Modification	7-7
7.5.3. Geometric Design Elements.....	7-7
7.6. Highway-Railroad Grade Crossings	7-8
7.6.1. Horizontal Alignment	7-8
7.6.2. Vertical Alignment	7-9
7.6.3. Highway-Rail Grade Traffic Control Considerations.....	7-9
7.6.4. Traffic Control Devices	7-11
7.6.5. Alternatives to Maintaining the Crossing	7-12
7.6.6. Crossing Consolidation and New Crossings	7-13
7.6.7. GDOT At-Grade Highway-Rail Crossing Evaluation Criteria.....	7-13

Chapter 7. AT Grade Intersections

The American Association of State Highway and Transportation Officials (AASHTO) *A Policy on the Geometric Design of Highways and Streets (Green Book)* defines an intersection as, “the general area where two or more roadways join or cross, including the roadway and roadside facilities for traffic movements within the area”. The main objective of intersection design should be to facilitate the safe and efficient movement of motor vehicles, buses, trucks, bicycles, and pedestrians.

7.1. Intersection Design Elements

The mobility and operational characteristics of a facility will depend on proper intersection design. Intersection design should closely fit the natural paths and operating characteristics of its users. The five basic elements that should be considered in intersection design are:

- **Human Factors** - driving habits, the ability of motorists to make decisions, driver expectations, decision and reaction time, conformance to natural paths of movement, pedestrian use and habits, bicycle use and habits.
- **Traffic Considerations** - design and actual capacities, design-hour turning movements, size and operating characteristics of vehicle, variety of movements (diverging, merging, weaving, and crossing), vehicle speeds, transit involvement, crash experience, bicycle movements, pedestrian movements.
- **Physical Elements** - character and use of abutting property, horizontal and vertical alignments at the intersection, sight distance, angle of the intersection, conflict area, speed-change lanes, geometric-design features, traffic control devices, lighting equipment, safety features, bicycle traffic, environmental factors, cross walks, parking, directional signing and marking.
- **Economic Factors** - cost of improvements, effects of controlling or limiting rights-of-way on abutting residential or commercial properties where channelization restricts or prohibits vehicular movements, energy consumption.
- **Functional Intersection Area** - boundary (much larger than the physical intersection; includes perception-reaction distance, maneuver distance, deceleration distance and queue-storage distance), access points.

7.2. Intersection Geometrics

7.2.1. Angle of Intersection/Skew Angle

Refer to **Chapter 4, Elements of Design, Section 4.1.6. Intersection Skew Angle**, of this Manual for design policies concerning intersection skew angle.

7.2.2. Right-of-Way Flares

Refer to Chapter 4, Elements of Design, Section 4.1.5. Intersection Sight Distance, for design policies concerning right-of-way flares.

7.2.3. Turn Lanes

The length of a turn lane consists of three components: entering taper, deceleration length, and storage length. Where practical, the total length of turn lane should be determined based on the design speed and the storage requirement for the turn lane and adjacent through-lane queue.

At a minimum, for design speeds < 35 mph, taper and deceleration lengths should be designed in accordance with the GDOT Regulations for Driveway and Encroachment Control.

At a minimum, for design speeds \geq 35 mph, taper and deceleration lengths should be designed in accordance with Georgia Construction Details M-3A or M-3B.

For further design guidance relating to the design of turn lanes, refer to the AASHTO Green Book, Chapter 9, Intersections - Auxiliary Lanes.

The following guidelines have been adopted by GDOT for the placement of deceleration lanes on multi-lane roadways with median widths greater than 12-ft:

- Left-Turn-Lanes should be incorporated inside the median at all median opening locations.
- When the posted speed is \geq 45 mph, Right-Turn-Lanes should be placed at paved public street intersections and entrances to major traffic generators.
- When the posted speed is < 45 mph, Right-Turn-Lanes should be placed at paved public street intersections and direct entrances to major traffic generators under the following conditions:
 - (a) Mainline current traffic volumes exceed 10,000 vehicles per day, and
 - (b) Traffic volumes on the side road exceed 200 vehicles per day with peak hour right turn movements from the main road exceeding 20 vehicles per hour.
- In addition, every effort should be made to replace existing right turn lanes at commercial driveways when practical. The benefits of including a turn lane may not always outweigh the impacts the turn lane will have on adjacent parcels. Sound engineering judgment should be used to determine if the benefits of replacing the right turn lane outweigh the impacts. Coordination with the Division of Engineering, Office of Traffic Operations, and District Access Management Engineer is recommended.

7.2.4. Islands

AASHTO defines an island as the “area between traffic lanes used for control of vehicle movement. Islands also provide for an area for pedestrian refuge and traffic control devices”. Islands may be raised or painted. AASHTO defines a refuge island as, “A refuge island for pedestrians is one at or near a crosswalk or bicycle path that aids protects pedestrians and bicyclists who cross the roadway”.

Refuge islands should be considered in areas where the roadway is too wide to allow a pedestrian to cross the entire intersection in one movement. Refer to **Toolkit 6 – Intersections, Medians and Center Refuge Islands, and Toolkit 7 – Crossings**, of the GDOT [Pedestrian and Streetscape](#)

[Guide](#)¹ for information related to median refuge island design. See Section 9.5.1 Pedestrian Accommodation Design under Mid-block Crossings of this manual for further information also, refer to **Section R305.2.4 Pedestrian Refuge Islands** of the [PROWAG](#)².

7.2.5. Intersection Radii

Turning radii treatments for intersections are important design elements that affect the operation, safety, and construction costs of the intersection. Several basic parameters should be considered in determining the appropriate corner radii and length of median opening including: intersection angle, number and width of lanes, design vehicle turning path, clearances, encroachment into oncoming or opposing lanes, parking lanes, shoulders, and pedestrian needs. The GDOT *Driveway Manual* provides typical radii for various applications.

7.3. Median Openings

Median openings should be planned and designed to reflect access management objectives along a roadway. The following guidelines should be considered when designing median openings as well as when requests are received for additional median openings on completed roadway sections:

- Priority should be given to establishing median openings at existing roads and streets before other locations.
- The location and design of a median opening should take into consideration the taper length, deceleration length, and storage length required to adequately satisfy the traffic volumes, and whether adequate space is available between adjacent median openings to satisfy these critical dimensions. Adequate sight distance should be available at all median opening locations.
- GDOT has adopted 1,000-ft. as the preferred minimum spacing between median openings in urban areas, and 1320-ft. as the preferred minimum spacing between median openings in rural areas. In urban areas, median openings may be spaced less than 1,000-ft., and greater than 660-ft. if it can be demonstrated that left turning volumes are nominal. Some innovative intersection forms such as the restricted crossing u-turn intersection (RCUT) may allow for a closer spacing of median openings. In such cases, median openings may be spaced closer than the above dimensions, if it can be demonstrated with an operational study that the requirements in the preceding bullet are satisfied.
- The maximum spacing between median openings in developed areas (including single occupied residence) should be one mile. In areas without any development or where there are no driveways due to access control, the maximum spacing between median openings should be 2 miles. In urban areas a practical maximum spacing between median openings is approximately ½ mile. Since it is preferable to place median openings only at local roads, the opening may be shifted slightly to line up with an existing road or major traffic generator.

¹<http://www.dot.ga.gov/PartnerSmart/DesignManuals/TrafficOps/GDOT%20Pedestrian%20and%20Streetscape%20Guide.pdf>

² <https://www.access-board.gov/attachments/article/743/nprm.pdf>

- Median openings for new and reconstructed facilities should be constructed in accordance with *GDOT Construction Standards and Details*, M-3, Type A, B, or C. The Type B design is preferred and should be used where drainage can be adequately designed and speeds are greater than or equal to 55 mph. Consideration for use of Type B crossovers should also be given when engineering judgment dictates that the design is practical in median widths less than 32-ft. and when there are more than two approach through lanes.
- Additional pavement for U-turns at median openings should be considered where there is a demand for access and where practical. In some cases, pavement for truck U-turns such as jug handles may be necessary to satisfy access to private property between successive median openings. Refer to the *GDOT Construction Standards and Details*, Construction Detail M-3, Type C Median Crossover. The designer should also refer to the National Cooperative Highway Research Program (NCHRP) report, *Safety of U-Turns at Unsignalized Median Openings (Report 524)*, when designing intersections with U-turn capability.
- For six-lane roadways, new or reconstructed full median openings should be studied to determine the appropriate intersection control. The study should evaluate a variety of intersection control types such as RCUTs, Median U-Turns, Two-Way Stops, Traffic Signals, etc. A traffic signal may only be considered as one of the alternatives if the intersection meets signal warrants.
- Median openings should not typically be installed or permitted to serve a particular development; however, when it can be demonstrated that such an installation will benefit the overall safety, traffic flow and efficiency of the roadway, then consideration will be given. Consideration for installing median openings for particular developments also involves the application of standard access control policy; **therefore, if a particular development is proposing to add a median opening to a roadway, and the design does not comply with design criteria adopted by GDOT, then the approval of a Design Variance from the GDOT Chief Engineer will be required prior to incorporating the opening or feature into a project design or along an existing roadway section.**

7.4. Driveways

GDOT considers driveways, or non-roadway access points to the State Route System, as essentially low-volume intersections that merit special consideration in their design and location.

The designer should be familiar with the policies and procedures described in the current version of *GDOT's Regulations for Driveway and Encroachment Control (Driveway Manual)*.

New driveways and modifications to existing driveways are regulated through the use of permits. Driveway permits (referred to as "access permits") are necessary in order to preserve the functional integrity of the State Highway System and to promote the safe and efficient movement of people and goods. Access permit regulations generally control right-of-way encroachment and driveway design, location, and number. Access approved for newly constructed commercial developments may, and in-fact often, stipulate parking requirements (for parking adjacent to state-owned rights of way) and setback distances to buildings and/or sign structures. When a roadway is widened, parking, setback distances, ingress/egress and parcel circulation may be impacted.

A consistent design approach should be applied to both existing driveways requiring reconstruction and proposed driveways for new developments. All reconstructed driveways should be compliant with the *GDOT Driveway Manual*. However, given the constraints of reconstructing an existing driveway, GDOT recognizes that it may not always be possible to reconstruct a driveway in strict accordance with the *GDOT Driveway Manual*. When roadways are to be widened, the replacement driveway may not require the same access/egress features, such as a right turn deceleration lane and/or acceleration lane. The need for the replacement of these features shall be evaluated on a case by case basis. In some cases replacement of access features in kind may not be justified due to excessive impacts to adjacent parcels.

The safety and efficiency of the State Highway System are affected by the amount and character of intersecting streets and driveways. While it is recognized that property owners have certain right of access, the public also has the right to travel on the road system with relative safety and freedom from interference. It is GDOT's intent to balance the often conflicting interests of property owners and the traveling public.

7.5. Signalization

The designer should be familiar with the current version of the *GDOT Policy 6785-1³, Traffic Signals*. The information contained in this Section is intended to supplement the information contained in *Policy 6785-1*. The following provides some general guidelines for signalized intersection design:

- All signalized intersections shall be designed in accordance with the *GDOT Traffic Signal Design Guidelines*.
- Distance between stop bars on opposing movements should be set to minimum standards wherever possible, thus minimizing necessary clearance timings.
- The use of pedestrian refuge islands should be considered whenever possible to minimize pedestrian clearance times.
- The designer should communicate with the District Utilities Engineer to compile a list of all utilities which may be affected both underground and overhead. The location of utilities should be included on the signal plans so that they may be avoided. Special attention should be given to overhead utilities crossing the intersection to ensure that they do not conflict with the proposed signal span wire, mast arms, or signal heads, and that the design is able to meet National Electric Safety Code requirements.
- Actual (existing) and projected (design) volumes, including turn movements, should be collected and determined for the intersection.
- The designer should determine if the proposed signal will be part of a coordinated signal system, and if so, the development of communication plans or timing plans are needed.

³ Policy 6785-1 is available on GDOT Policies and Procedures at:
<http://mygdot.dot.ga.gov/applications/gdotpubs/Publications/Forms/AllItems.aspx>

- The designer should closely evaluate the sequence of construction and maintenance of traffic to determine if temporary signals are needed.
- Where possible signal poles / mast arms should be located to allow for use with both temporary signalization, and final signalization.
- The intersection controller cabinet shall be located where it can be utilized in the temporary signals, as well as the final signal design.
- Location of the PED button and PED signal, curb cut ramps, strain pole, controller cabinets, crosswalk and landing areas, should all be coordinated to ensure a fully accessible intersection. The designer should check the right of way to ensure that there is enough room to install these items.
- The intersection controller cabinet shall be located to avoid creating a sight distance obstruction in all phases of construction.
- Signal heads shall be designed with sufficient slack wiring to allow the heads to be relocated to different places on the span wire / mast arm for use in both the temporary and final signals.
- Wherever possible, loops, pullboxes, and loop lead-ins shall be placed to be used for both the temporary signals as well as the final signals.
- For signals mounted on mast arms, the designer should provide sufficient length on the arms to allow for both future signal heads, as well as field adjustments if needed.
- The designer should contact the maintaining agency that is responsible for the existing intersections in the area to determine design standards which may be unique to the area.
- As applicable, the construction of the signalized intersection should be carefully considered when developing maintenance of traffic plans.
- Consider decision sight distance as it relates to signal head and traffic control devices, and the queue length for the signal.
- When designing a roadway or roadway improvements, particular attention should be paid to the future operations at the project intersections. Where existing signalization does not exist, the intersection should be evaluated to determine if signalization is required as part of the project. If the project includes an existing signalized intersection, the intersection should be evaluated to determine if improvements are required as part of the project.

7.5.1. New Intersections and Existing Unsignalized intersections

At existing non-signalized and new intersections which are a part of the project design, the designer should request the District Traffic Operations Engineer perform a Traffic Engineering Study (including a signal warrant analysis) to determine if signalization may be warranted. The results of the study, along with the recommendations shall be documented in a Traffic Engineering Report.

The signal warrant analysis shall be performed in accordance with the current version of the FHWA *Manual on Uniform Traffic Control Devices* (MUTCD)⁴.

The Traffic Engineering Study should be performed under two separate scenarios:

- At locations where the intersections exist in the field, the intersection should be evaluated under existing volumes (as determined by field counts) and future lane configuration (based on the project design). If the intersection meets warrants under these conditions, the signal design should be included in the design package, and the signal should be installed as part of the project construction.
- At locations where an intersection exists in the field but does not meet warrants under existing traffic conditions, and at locations where the intersection does not exist in the field (new intersection as part of the design project) the intersection should be evaluated using design volumes (volumes developed as part of a traffic study) and future lane configuration (based on project design). Intersections that meet warrants under this scenario should be considered for inclusion in the design package. The designer should work closely with the District Traffic Operations Engineer to determine if signalization should occur as part of the project, or in a future stage.

In either case, the roadway / intersection should be designed to allow for future signalization. Necessary turn lanes should be provided, or space to develop future turn lanes should be planned. Right-of-way should be provided for future signal poles and intersection equipment.

7.5.2. Signal Modification

New signal plans should be developed for all existing signalized intersections where roadway improvements are being made. The existing signalized intersection should be evaluated to determine its existing operation. The intersection should then be analyzed with both existing volumes and design volumes using the future lane configuration to determine the appropriate intersection phasing. If future phasing changes will be needed, design allowance should be incorporated to provide room for additional signal heads, loop detectors, and mast arm lengths. Any modification to existing signals requires a revision to the existing signal permit.

7.5.3. Geometric Design Elements

In rural areas, if there will be an auxiliary lane for acceleration after a right turn movement, it must provide adequate acceleration length to merge into traffic (as discussed in this Manual in **Chapter 4, Elements of Design, Section 4.2.5. Transition in Number of Lanes**). The lane must also be free of any driveways for the length of the auxiliary lane.

⁴ FHWA. Manual on Uniform Traffic Control Devices (MUTCD).

The 2009 version is available online at: http://mutcd.fhwa.dot.gov/pdfs/2009r1r2/pdf_index.htm

7.6. Highway-Railroad Grade Crossings

When a Highway- Railroad grade crossing is included on a project, designers should coordinate with the GDOT Railroad Crossing Manager, [Railroad Crossing Improvement Unit⁵](#), in conjunction with concept development for a transportation improvement project.

The designer should be familiar with most current versions of the following resources:

- AASHTO *A Policy on the Geometric Design of Highways and Streets (Green Book)*, Chapter 9. Intersections
- American Railway Engineering and Maintenance of Way Association (AREMA) specifications (visit www.arema.org for additional information)
- Railway company regulations
- GDOT Standard Drawing and Specifications
- FHWA *Manual on Uniform Traffic Control Devices (MUTCD)*

A highway-railroad crossing involves either a separation of grades or a crossing at-grade. GDOT strongly encourages consideration of grade separated highway-railroad crossings. However, topographical and/or right-of-way limitations may make at-grade crossings the more feasible option.

When an at-grade, highway-railroad crossing is included in the design of a roadway construction/reconstruction project, personnel with the Railroad Crossing Improvement Unit will review each crossing within 500 ft. of the project limits. The review will determine the adequacy of warning devices (i.e. gates, lights, and bells) at the specific at-grade crossing and provide recommendations to be included in the design.

The geometric design of a highway-railroad grade crossing involves the elements of alignment, profile, sight distance, and cross section. The roadway should cross the railroad at- or nearly at- a right angle. The roadway gradient should be flat at- and adjacent to- the railroad crossing to permit vehicles to stop, when necessary, and then proceed across the tracks without difficulty. The vehicle operator can observe an approaching train and bring the vehicle to a stop prior to encroaching into the crossing area. Also the roadway width at all crossings should be the same as the roadway width approaching the crossing.

7.6.1. Horizontal Alignment

As per the AASHTO *Green Book*, to the extent practical:

- The highway should be designed to intersect the railroad tracks at a right angle.
- There should be no intersections or driveways, and in areas where a highway intersection is close to a railroad crossing, sufficient distance between the tracks and the highway intersections should be provided to enable highway traffic in all directions to move expeditiously. Where adequate storage distance between the main track and a highway

⁵ The Railroad Crossing Improvement Office

<http://www.dot.ga.gov/PartnerSmart/utilities/Pages/Details.aspx?categoryID=17>) is a unit of the GDOT Office of Traffic Safety and Design (home page: <http://mygdot.dot.ga.gov/gdotoffices/traffic/Pages/default.aspx>).

intersection is not available, interconnection of the highway traffic signals with the train-activated warning devices and appropriate signage and pavement markings is strongly recommended.

- Placement of crossings on highway or railroad curves should be avoided because a roadway curvature can inhibit a driver's view of the crossing ahead, a railroad curvature may inhibit a driver's view down the tracks from both a stopped position at the crossing and on the approach to the crossing, and crossings located on both highway and railroad curves present maintenance problems and poor rideability for highway traffic due to conflicting superelevations.

7.6.2. Vertical Alignment

As per the AASHTO *Green Book*, to the extent practical:

- Highway and railroad intersections should be level:

The crossing surface should be at the same plane as the top of the rails for a distance of 2-ft. outside the rails. This is done to prevent low clearance vehicles from becoming caught on the railroad tracks.

The surface of the highway should not be more than three inches higher or lower than the top of the nearest rail at a point 30-ft. from the rail, unless track superelevation makes a different level appropriate.

If a roadway approach section is not level, or if the rails are superelevated, adequate rail clearances should be determined through a site-specific analysis.

- Vertical curves should be of sufficient length to ensure an adequate view of the crossing.
- Vertical curves should be used to traverse from the highway grade to a level plane at the elevation of the rails.

7.6.3. Highway-Rail Grade Traffic Control Considerations

Highway-rail grade crossing traffic control considerations are discussed in detail in the FHWA publication, *Guidance on Traffic Control Devices at Highway-Rail Grade Crossings*⁶. The following discussion summarizes the key points of this FHWA publication.

At a highway-rail grade crossing, the train always has the right of way. The process for determining the types of highway traffic control device(s) that are needed at a highway-rail grade crossing, or if a highway-rail crossing should exist, involves two-steps:

- Required Information - identifying what information the vehicle driver needs to be able to cross safely

⁶ FHWA. *Guidance on Traffic Control Devices at Highway-Rail Grade Crossings*. 2002

The 2002 version of this publication is available online at:

https://safety.fhwa.dot.gov/intersection/other_topics/fhwas09027/resources/Guidance%20On%20Traffic%20Control%20at%20Highway%20Rail%20Grade.pdf

- System operating characteristics - determining if the resulting driver response to a traffic control device is “compatible” with the intended system operating characteristics of the highway and the railroad facility.

Required Information

The first step involves three essential elements required for ‘safe’ passage through an at-grade crossing, which are incidentally the same elements a driver needs for crossing a highway-highway intersection:

- **Advance notice / stopping sight distance** – this element involves the drivers’ ability to see a train and/or the traffic control device at the crossing ahead to bring the vehicle to a stop at least 15-ft. short of the near rail.
- **Traffic control device comprehension** – this element is a function of the types of traffic control devices at the highway-rail crossing. According to FHWA, “there are typically three types of control devices, each requiring a distinct compliance response per the Uniform Vehicle Code, various Model Traffic Ordinances, and state regulations” (2002). These three types of control devices are: crossbuck, operating flashing lights that have the same function as a STOP sign, and flashing lights with lowered gates that have the same function as a red vehicular traffic signal.
- **Driver decision to proceed through the grade crossing** - this element concerns the driver’s decision to safely proceed through the grade crossing. It involves sight distance available both on the approach and at the crossing itself.

System Operating Characteristics

The second step involves a traffic control device selection process considering respective highway and rail system operational requirements. Within these contexts, FHWA notes the following operation and safety variables that should be considered (2002):

- highway - AADT (Annual Average Daily Traffic), legal and/or operating speed
- railroad - train frequency, speed and type (passenger, freight, other)
- highway - functional classification and/or design level of service
- railroad - FRA class of track and/or high speed rail corridors
- proximity to other intersections
- proximity to schools, industrial plants, and commercial areas
- proximity to rail yards, terminals, passing tracks, and switching operations
- available clearing and corner sight distance
- prior accident history and predicted accident history
- proximity and availability of alternate routes and/or crossing
- other geometric conditions

“Special consideration should also be given to situations where highway-rail crossings are sufficiently close to other highway intersections that traffic waiting to clear the adjacent highway

intersection can queue on or across the tracks, and when there are two or more sets of tracks sufficiently close to each other that traffic stopped on one set could result in a queue of traffic across the other” (FHWA, 2002).

Highway Operational Requirements

FHWA describes the following with respect to highway operational requirements of highway-rail grade crossings (2002):

- Passive highway-rail grade crossings with a restricted sight distance require an engineering study to determine the safe approach speed based upon available stopping and/or corner sight distance.
- As a minimum, an advisory speed posting may be appropriate, or a reduced regulatory speed limit might be warranted.
- Active devices improve highway capacity and level of service near a crossing, particularly where corner sight distances are restricted; however, the effects of such a stop delay will increase as traffic volumes increase which will result in vehicle delay increases.

The type of control installed at highway-rail crossings should be evaluated in the context of the highway system classification and level of service.

Railroad Operational Requirements

“Function, Geometric Design, and Traffic Control - Functional classification is important to both the highway agency and railroad operator. Where the highway intersects a railroad, the crossing, whether grade separated or at-grade, should be designed consistently with the functional classification of the highway or street. These design considerations can also extend to traffic control” (FHWA, 2002).

7.6.4. Traffic Control Devices

The purpose of traffic control at highway-rail grade crossings is to permit safe and efficient operation of both vehicle and train traffic over such crossings. Highway vehicles approaching a highway-rail grade crossing should be prepared to yield and stop, if necessary, if a train is at or approaching the crossing.

Refer to the current FHWA *Guidance on Traffic Control Devices at Highway-Rail Grade Crossings* and the current FHWA *MUTCD* for additional information relating to the following types of highway-rail grade crossing traffic control devices:

- **Passive Devices** - all highway-rail crossings having signs and pavement markings (if appropriate to the roadway surface) as traffic control devices that are not activated by trains. Passive highway-rail crossing devices include: highway-rail grade crossing (crossbuck) signs, STOP signs, and YIELD signs.
- **Active Devices** - all highway-rail grade crossings equipped with warning and/or traffic control devices that gives warning of the approach or presence of a train. Active devices are generally categorized as standard active devices (i.e. flashing-light signals, cantilever flashing-light signals, and automatic gates) and supplemental active devices (i.e. active warning signs with flashers, or active turn restriction signs).

- **Median Separation** - the numbers of crossing gate violations can be reduced by restricting driver access to the opposing lanes. The use of median separation devices have resulted in a significant reduction in the number of vehicle violations at crossing gates. Other positive-barrier devices that can be used to prohibit crossing gate violations include: barrier walls, wide raised medians, non-mountable curb islands, mountable raised curb systems, four-quadrant traffic gate systems, and vehicle arresting barrier system - barrier gates.
- **Train Detection Systems** - Joint study and evaluation is needed between the highway agency and the railroad to make a proper selection of the appropriate train detection system. Refer to the current FHWA *Guidance on Traffic Control Devices at Highway-Rail Grade Crossings* for additional information relating to issues specific to train detection systems, such as warning time, system credibility, various types of detection systems, as well as railroad train detection time and approach length calculations.

7.6.5. Alternatives to Maintaining the Crossing

Refer to the current FHWA publication, *Guidance on Traffic Control Devices at Highway-Rail Grade Crossings*, for additional information on the following alternatives to maintaining a highway-rail grade crossing:

- **Crossing Closure** – “The crossing closure decision should be based on economics; comparing the cost of retaining the crossing (maintenance, crashes, and cost to improve the crossing to an acceptable level if it would remain, etc.) against the cost (if any) of providing alternate access and any adverse travel costs incurred by users having to cross at some other location. Because this can be a local political and emotional issue, the economics of the situation cannot be ignored” (FHWA, 2002). FHWA recommends two documents that provide guidance with regard to political, emotional, and economic ramifications of closing an at-grade highway-railroad crossing: a joint FRA/FHWA publication entitled *Highway-Railroad Grade Crossings: A Guide to Crossing Consolidation and Closure* (1994), and a March 1995 AASHTO publication, *Highway-Rail Crossing Elimination and Consolidation*.
- **Grade Separation** – FHWA notes that the decision to grade separate a highway-rail crossing should be based on long term, fully allocated life cycle costs, including both highway and railroad user costs, rather than on initial construction costs (2002). A 1999 Texas Transportation Institute report entitled “*Grade Separations-When Do We Separate?*” provides a stepwise procedure for evaluating the grade separation decision and also describes a rough screening method based on train and roadway vehicular volumes. Evaluation of the feasibility of highway-rail grade separation should consider many factors, including but not limited to:
 - eliminating train/vehicle collisions (including the resultant property damage and medical costs, and liability)
 - savings in highway-rail grade crossing surface and crossing signal installation and maintenance costs
 - driver delay cost savings
 - costs associated with providing increased highway storage capacity (to accommodate traffic backed up by a train)

- fuel and pollution mitigation cost savings (from idling queued vehicles)
- effects of any “spillover” congestion on the rest of the roadway system
- the benefits of improved emergency access
- the potential for closing one or more additional adjacent crossings
- possible train derailment costs

7.6.6. Crossing Consolidation and New Crossings

Crossing Consolidation

Guidelines for crossing consolidation can be found in publications such as:

- FRA/FHWA. *Highway-Railroad Grade Crossings, a Guide to Crossing Consolidation and Closure*. Federal Railroad Administration/Federal Highway Administration. 1994.
- FRA/FHWA. *Highway-Rail Crossing Elimination and Consolidation, A Public Safety Initiative*. National Conference of State Railway Officials. March 1995.

Furthermore, GDOT, road authorities, or local governments may choose to develop their own criteria for closures based on local conditions. The FRA and FHWA strongly encourage the use of specific criteria or an approach to consolidating railroad crossings, so as to avoid arbitrarily selecting a crossing for closure.

New Crossings

Similar to crossing closure/consolidation, consideration of opening a new public highway-rail crossing should likewise consider public necessity, convenience, safety, and economics. Generally, new grade crossings, particularly on mainline tracks, should not be permitted unless no other viable alternatives exist and, even in those instances, consideration should be given to closing one or more existing crossings to offset the additional risks associated with creating an additional crossing. If a new grade crossing is to provide access to any land development, the selection of traffic control devices to be installed at the proposed crossing should be based on the projected needs of the fully completed development. Communities, developers, and highway transportation planners need to be mindful that once a highway-rail grade crossing is established, drivers can develop a low tolerance for the crossing being blocked by a train for an extended period of time. If a new access is proposed to cross a railroad where railroad operation requires temporarily holding trains, only grade separation should be considered.

(FRA/FHWA, 2002)

7.6.7. GDOT At-Grade Highway-Rail Crossing Evaluation Criteria

Peabody-Dimmick Formula

The Peabody-Dimmick empirical method should be used to evaluate and establish an unadjusted “hazard index” for at-grade highway-railroad crossings. The Peabody-Dimmick Formula (often referred to as the Bureau of Public Roads Formula) is used to determine the expected number of train-vehicle crashes in five years. The formula is:

$$A_5 = 1.28 * ((V^{0.170} * T^{0.151}) / P^{0.171}) + K$$

Where:

- A_5 = Expected number of train-vehicle crashes in five years (Unadjusted Hazard Index Rating, as it is not adjusted for school buses)
- V = Annual Average Daily Traffic (AADT)
- T = Average Daily Train Traffic
- P = At-grade Crossing Protection Coefficient
- K = Balancing factor used to offset variations in empirical data

Note: The hazard index only provides an initial approximation of the relative hazard rating of each crossing. While the Peabody-Dimmick formula takes into account the number of daily trains, the vehicular AADT, and a factor for the existing warning devices (protection coefficient); the designer must consider other factors that must be considered before reaching an Adjusted Hazard Index rating for a crossing. These factors include:

- visibility and sight distances
- speed (both train and vehicle)
- number of past train-vehicle crashes at the location
- number of tracks
- highway approach grades
- highway alignment
- number of highway approach lanes
- type of terrain
- nearby intersections
- condition of existing equipment

Based on site-specific information not included in the formula, GDOT's current practice is that the Unadjusted Hazard Index rating produced by the Peabody-Dimmick Formula shall not account for more than 50% of the Adjusted Hazard Index rating.

Adjusted Hazard Index Rating

The Adjusted Hazard Index (AHI) Rating is the summation of the Unadjusted Hazard Index rating, the Adjustment Factor for School Buses, and the Adjustment for Train-Vehicle Crash history.

$$AHI = A_5 + S + A$$

Where:

- A_5 = Unadjusted Hazard Index Rating
- S = Adjustment factor for School Buses
- A = Adjustment for train-vehicle crash history

Adjustment Factor for School Buses

An adjustment factor should be added to the hazard index when a school bus route intersects a railroad 'at-grade'. The adjustment factor, *S*, takes into account the number of school buses traversing the highway-rail crossing during a 24-hour period.

$$S = \frac{(4 * TPD + 8 * Buses) + 8}{10}$$

Where: *S* = Adjustment Factor for School Buses
 TPD = Number of Trains per day
 Buses = Number of Buses per day

Adjustment Factor for Train-Vehicle Crash History

An adjustment factor should be added to the hazard index based on crash history at a highway-rail crossing. The adjustment factor, *A*, takes into account the number of fatalities, injuries, or property damage only cases when train-vehicle crashes occur.

$$A = 2 * F + 1 * I + 0.5 * PD$$

Where: *A* = Adjustment Factor for Accidents
 F = A train-vehicle crash resulting in a fatality
 I = A train-vehicle crash resulting in an injury
 PD = A train-vehicle crash resulting in property damage only

Note: If a train-vehicle crash results in a fatality, the Adjustment Factor for the train-vehicle crash is 2. (It should be assumed that subject vehicle's occupants were injured and the vehicle involved in the incident was damaged).

Intentionally Left Blank

Chapter 8. Roundabouts - Contents

Chapter 8. Roundabouts - Contents	8-i
8.1. Introduction	8-1
8.2. Roundabout Validation	8-1
8.2.1. ICE Stage 1 – Screening	8-2
8.2.2. ICE Stage 2 – Alternative Selection	8-5
8.2.3. Concept Validation Requirements of Roundabouts	8-5
8.2.4. Lighting	8-6
8.2.5. Public Involvement	8-7
8.3. Design Guidelines	8-8
8.3.1. Review of Construction Plans	8-9
8.3.2. Design Vehicle	8-9
8.3.3. Alignment of Approaches	8-9
8.3.4. Splitter Islands	8-9
8.3.5. Pedestrian Accommodations	8-10
8.3.6. Bicycle Accommodations	8-10
8.3.7. Treatments for High Speed Approaches	8-10
8.3.8. Drainage	8-11
8.3.9. Curbing	8-11
8.3.10. Pavement	8-11
8.3.11. Staging of Improvements	8-11
8.3.12. Traffic Control Devices	8-12
8.3.13. Landscaping	8-12
8.3.14. Construction	8-12
8.4. References	8-13
8.4.1. Primary References	8-13
8.4.2. Additional References	8-13
8.5. Definitions	8-14
8.5.1. Roundabout Physical Features	8-14
8.5.2. Roundabout Glossary of Terms	8-17

Chapter 8. Roundabouts

8.1. Introduction

Among the various intersection control strategies available to GDOT, the modern roundabout stands out as a leading alternative for addressing safety and operational needs.¹

A modern roundabout is a type of circular intersection characterized by channelized approaches, yield control at entry, counterclockwise circulation around a central island, and geometric features that create a low-speed environment. Roundabouts have been demonstrated to provide a number of safety, operational, and other benefits when compared to other types of intersections. Specifically, they have fewer conflict points, compared to conventional at-grade intersections, lower speeds, and have been found to reduce crashes, crash severity, traffic delays, fuel consumption, and air pollution.

Roundabouts are categorized into three basic types: mini-, single-lane, and multilane roundabouts. A detailed introduction to each is provided in Chapter 1 of the National Cooperative Highway Research Program (NCHRP) [Report 672, Roundabouts: An Informational Guide, 2nd Edition](#). This chapter of the GDOT Design Policy Manual specifically addresses single-lane and multilane roundabouts; for the design of mini-roundabouts refer to [NCHRP 672](#) and [FHWA-SA-10-007 – Mini-Roundabouts, Technical Summary, February 2010](#).

In 2008 FHWA released [Guidance Memorandum on Consideration and Implementation of Proven Safety Countermeasures](#), which identifies roundabouts as one of nine safety countermeasures recognized and supported by FHWA. GDOT also considers roundabouts as an effective safety and operational alternative for a wide range of roadway intersections.

The consideration of a roundabout begins with Stage 1 of an [Intersection Control Evaluation \(ICE\)](#). If a roundabout is a feasible alternative for intersection control, then it should be carried forward into an ICE Stage 2 for further evaluation. If a roundabout is selected as the preferred alternative, then a concept layout, along with geometric design checks (in most cases) should be prepared and included in the Concept Report or Revised Concept Report for standalone intersection projects.

Each proposal for a roundabout should be evaluated and designed based on the guidelines contained in [NCHRP 672](#), and the guidelines presented in the following sections of this chapter. Additional guidance documents are listed in Section 8.4.1.

8.2. Roundabout Validation

The decision to propose a roundabout as a preferred alternative, is validated through the ICE Stage 1 – Screening, and ICE Stage 2 – Alternative Selection. In these studies the performance of many types of intersection and interchange controls are evaluated for a particular location to determine the best possible overall value in terms of performance-based criteria.

¹ Information regarding roundabouts in Georgia can be found on the [GDOT Roundabouts web page](http://www.dot.ga.gov/DriveSmart/SafetyOperation/Pages/Roundabouts.aspx) at <http://www.dot.ga.gov/DriveSmart/SafetyOperation/Pages/Roundabouts.aspx>

Chapter 3 of [NCHRP 672](#) provides supplemental guidance for the ICE methodology as it applies specifically to roundabouts, for comparing the performance of a roundabout to other intersection control types.

8.2.1. ICE Stage 1 – Screening

As part of the ICE Stage 1 – Screening, the suitability of a roundabout alternative is evaluated based upon site-specific conditions and needs. This includes initial screening of operational and safety implications as well as an initial identification of the intersection footprint.

Exhibit 3-1 of NCHRP 672 provides additional planning-level discussion to aid in this initial screening of a roundabout alternative. An overview of common advantages and disadvantages of roundabouts is presented in Exhibit 2-5 of [NCHRP 672](#). Section 8.2.1.1 to 8.2.1.3 within this chapter, outline ICE Stage 1 practical screening considerations for roundabouts.

The presence of any of the following conditions will normally be unfavorable for a roundabout and should be documented in the ICE Stage 1. These conditions do not preclude a roundabout from further consideration, but should be carefully considered when determining whether a roundabout alternative is feasible and should be further evaluated in an ICE Stage 2.

- Intersections in close proximity to a signalized intersection where queues may spill back into the roundabout.
- Locations with steep grades and unfavorable topography that may limit visibility of the roundabout from a distance.
- Intersections where an unacceptable delay to the major road could be created. Roundabouts introduce some geometric delay to all through and left turning traffic entering the intersection, including the major road.
- Intersections within an interconnected signal system.
- At locations where the pedestrian traffic signal warrant is met (i.e., Warrant No. 4 in MUTCD, Pedestrian Volume)
- Signalized intersections in close proximity to an at-grade railroad crossing requiring preemption.

8.2.1.1. Roundabout Operational Considerations

The following operational indications favor the advancement of a roundabout past ICE Stage 1 screening:

- Intersections with a high percentage of turning movements and intersections that must accommodate a high number of U-turns.
- Intersections with high traffic volumes at peak hours but relatively low traffic volumes during non-peak hours.
- Where traffic signals are warranted but high speed approaches justify a roundabout for optimal safety.
- Corridors needing link and intersection capacity expansion. Using roundabouts in a series can reduce the number of lanes between intersections.

- Closely spaced intersections where traffic signal coordination is difficult to achieve.
- Ramp terminals for freeway interchanges. Roundabouts often make more efficient use of an existing bridge by eliminating or reducing the lane and storage requirements on the bridge.
- Intersections where the construction of turn lanes for a signal would have significant impacts on adjacent property or require significant reconstruction of structures. While roundabouts may have a larger footprint on the corners of the intersection, the overall space requirement for a roundabout is often less than for a conventional intersection. This is due to the elimination or reduction of storage lanes on approach roadways.
- Intersections where widening one or more approach, to add turn lanes, would be difficult or cost-prohibitive.
- Intersections where signalization provides an unacceptable delay.
- Existing two-way stop-controlled intersections with high side-street delays, particularly those that do not meet signal warrants.
- Locations where the speed environment or number of through lanes of a road changes, for instance, at the transition to an urban environment.
- Intersections or corridors where traffic calming is a desired outcome of the project.
- As part of an overall corridor access management strategy to provide enhanced locations for U-turns.

Table 8.1 can be used to estimate the number of circulatory lanes required for single or two-lane roundabouts. In most cases one and two-lane roundabouts should operate acceptably below these thresholds. Actual performance is significantly affected by the percentage of left turning traffic.

When available, traffic count data can be used or historical volume records and estimates can be obtained from the [GDOT Traffic Count](#) website. Alternately, an estimate of the required number of entry lanes at each approach can be obtained using Exhibit 3-14 of [NCHRP 672](#). Sample calculations are provided in Exhibits 3-15 and 4-3 of [NCHRP 672](#).

For a roundabout to be a reasonable solution, the opening and design year volumes for traffic entering the roundabout from the major road should be less than 90% of the total volume entering the roundabout.

Table 8.1. Thresholds for Single-Lane and Two-Lane Roundabouts based on ADT.

No. of Circulatory Lanes	ADT ¹ (design year)	% Traffic on Major Road ² (opening & design year)
Single-lane	< 25,000	< 90
Two-lane	< 45,000	< 90

¹Based on traffic entering the circulatory roadway for a four-leg roundabout. A reasonable approximation for a three-leg roundabout is 75% of the values shown above.
²The volume of traffic entering the roundabout from the major road divided by the total traffic volume entering the roundabout, as a percentage.

Note: If traffic volumes exceed the maximum ADT thresholds shown in Table 8.1 (i.e., 45,000 and 90%), or if site conditions are unfavorable to a roundabout, then it may be removed from further consideration during ICE Stage 1. Nevertheless, a roundabout may still operate better than other intersection types and may be carried forward for more detailed evaluation in ICE Stage 2.

8.2.1.2. Roundabout Safety Considerations

The following safety-related conditions favor the advancement of a roundabout past ICE Stage 1 screening:

- Intersections with historically high crash rates
- Roads with historical problems of excessive speed
- Intersections with more than four legs or with difficult skew angles

An assessment of safety benefit will be based on the expected reduction in crashes, specifically on those resulting in fatalities and injuries.

8.2.1.3. Other Roundabout Considerations

The following considerations also favor using roundabouts:

- Skewed angle intersections (less than 80°) where realignment of the approaches for other forms of traffic control is costly and /or impactful.
- Intersections with five or more legs.
- Intersections at a gateway or entry point to a campus, neighborhood, commercial development, or urban area. These may be locations with a need to provide a transition between land-use environments such as between residential and commercial areas.
- Intersections where community enhancement is desirable.

8.2.2. ICE Stage 2 – Alternative Selection

When an ICE Stage 1 determines a roundabout alternative to be feasible, it should be advanced to an ICE Stage 2 and evaluated in more detail. For each section within the ICE Stage 2, the following considerations are specific to the roundabout alternatives:

- **Traffic Operations:** If a single-lane roundabout is found to be adequate up to 10 years after the opening year, a single-lane roundabout should be constructed. If a multilane roundabout is then required before the design year, the single-lane roundabout should be constructed having the footprint of a multilane roundabout and be designed to be easily retrofitted to a multilane roundabout (see Section 6.12 of [NCHRP 672](#)). Further guidance on evaluating the operational performance of roundabouts can be found in Highway Capacity Manual, Sixth Edition: A Guide for Multimodal Mobility Analysis (HCM6). See also Chapter 4 of [NCHRP 672](#). Analysis should be performed using more than one analysis methodology to identify a range of expected performance during the design period (i.e. opening to design years). For example, analyses can be performed using the [GDOT Roundabout Analysis Tool](#) to implement the HCM6 method and the “SIDRA Standard” method (use environmental factor 1.1 for the opening year and 1.05 for the design year) using the software package SIDRA intersection.

A simulation software package, such as VISSIM, can be used when modeling of a network of closely spaced intersections is necessary.

- **Safety Analysis:** It may be beneficial to prepare crash diagrams. Crash diagrams should show the types of crashes and the direction each car was traveling. A roundabout is particularly effective for addressing crashes involving crossing, turning and opposing (i.e. head on collisions) traffic.

Further information regarding safety and roundabouts is presented in Chapter 5 of [NCHRP 672](#) and in the [AASHTO Highway Safety Manual \(HSM\)](#).

8.2.3. Concept Validation Requirements of Roundabouts

If a roundabout alternative is recommended as the preferred intersection control, conceptual roundabout design validation should take place. This advances a concept level layout to a more detailed geometric design of the roundabout and approaches. This layout should include the size and location of the roundabout and the alignment and arrangement of approaches. Major geometric components should be shown including splitter islands, circulatory roadway, truck aprons, accommodation for Oversize/Overweight (OSOW) vehicles, center islands, and bypass lanes (if required). Roundabout concept validation will be included as an attachment to the concept report for stand-alone intersection improvement projects. Roundabout validation will occur at no later than the completion of phase 2 of ICE for other project types.

Documentation of OSOW ‘check vehicles’, typically oversize and/or overweight trucks, must also be established during the concept validation stage as truck space requirements can lead to larger intersection footprints. Document the vehicle types, directions and turning movements.

A list of the criteria used to develop the selected layout and key dimensions should be provided. Provide dimensions for: (1) inscribed diameter, (2) entry and exit radii, and (3) entry, circulatory, roadway, and truck apron widths. It is noted that the selection of the most favorable roundabout

location and configuration may require the development and comparison of multiple roundabout layouts.

Geometric and performance checks will be included in DGN format as part of a roundabout concept validation, including fastest path, design and check vehicle swept paths, and stopping sight distance for all approaches. Submittals can be made by sending an e-mail to RoundABOUTs@dot.ga.gov. Operational analyses prepared during the ICE Stage 2 process may need to be updated as a result. Other performance checks, e.g. intersection sight distance and OSOW clearance checks should be completed during preliminary design (See Section 6.7 of [NCHRP 672](#)).

8.2.4. Lighting

The lighting of a roundabout has been identified by the Department as having substantial importance to the operational performance and safety of a roundabout such that special attention should be given to the design decision. Therefore, GDOT has defined the illumination levels in Table 12-4 of the Illuminating Engineering Society (IES) [RP-8-18 Recommended Practice for Design and Maintenance of Roadway and Parking Facility Lighting](#) (IES DG-19-08) as standard for the design of roundabout lighting. **If it is not practical to provide the illumination levels defined in this table, then a decision to deviate from this table shall require a comprehensive study by the engineer and prior approval of a Design Variance by the GDOT Chief Engineer.**

[NCHRP 672](#) emphasizes the safety importance of roundabout lighting for all users of roundabouts and includes the below statements.

For a roundabout to operate satisfactorily, a driver must be able to enter the roundabout, move through the circulating traffic, and separate from the circulating stream in a safe and efficient manner. Pedestrians must also be able to safely use the crosswalks. To accomplish this, a driver must be able to perceive the general layout and operation of the intersection in time to make the appropriate maneuvers. Adequate lighting should therefore be provided at all roundabouts. [[NCHRP 672](#) Section 8.1]

It provides visibility from a distance for users approaching the roundabout. [[NCHRP 672](#) Section 8.2]

It provides visibility of the key conflict areas to improve users' perception of the layout and visibility of other users within the roundabout. [[NCHRP 672](#) Section 8.2]

Pedestrians are the most vulnerable users of a roundabout. Thus, an important function of lighting at a roundabout is to ensure that any pedestrian in the crosswalk is visible to vehicles approaching, entering, and exiting the roundabout. Roadway lighting also provides increased safety to cyclists, at the approach to the roundabout where they begin to mix with vehicular traffic and throughout the circulatory roadway where they may be integrated into the traffic stream.

A written commitment letter must be received from a local government agreeing to share the costs of lighting (by funding the energy, operation and maintenance of the lighting system) in order for the proposed roundabout to move forward to detailed design (See Figure 8.1). Lighting plans should be developed consistent with the guidelines presented in [IES RP-8-18](#) and Chapter 14 of the DPM.

8.2.5. Public Involvement

The public involvement process should be started early and staged to educate the internal stakeholders and local agency officials in the benefits of a roundabout. In communities where there is little familiarity with roundabouts, it is recommended that a meeting be held with local government officials prior to a Public Information Open House (PIOH). A roundabout subject matter expert or an individual with considerable knowledge of roundabouts should be present at this meeting.

Outreach to local government officials is conducted first then outreach to the local community should be initiated as soon as practical during the evaluation of feasible alternatives (ICE Stage 2) and concept development. At a minimum, a PIOH should be held for all multilane roundabouts and for single-lane roundabouts where there are no other well-functioning roundabouts in the community or nearby along the corridor. This includes minor projects for which a PIOH may not otherwise be required.

Below are suggested “best practices” for preparing for a PIOH.

- Offer an information session on roundabouts to the local officials and include project specific information. This could be a dry run for a future Public Information Open House (PIOH). Handouts should include talking points or frequently asked questions:
 - Project funding source
 - Timing of construction
 - Anticipated road closures and detours
 - What is a roundabout and why is the Department proposing one (safety and/or congestion relief?)
 - Where are we in the project development process
 - Links to GDOT roundabout resources (brochures and website)
 - Visualization, either with animation (VISSIM) or show the roundabout layout on a plot to scale with toy cars and trucks (1:87 scale plot)
 - Sample brochures on how to use roundabouts
- Prepare several large color displays that show the proposed location and layout of the roundabout. Arrange the meeting space into ‘stations’ where different media are used, e.g. video at one station, roll-plot at another, tripod displays, comment cards, etc. The display should include aerial photography and property lines. The following may also be included:
 - proposed pavement markings with lane arrows;
 - proposed landscaping in the central and splitter islands (if required); and
 - truck turning paths (on a separate display).
- Be prepared with a comparison of cost, safety, and operational performance of the roundabout and other feasible alternates. Accordingly, the following information should be made available at the meeting:
 - construction cost estimates for feasible alternates (e.g., roundabout and signal);

- crash history and an assessment of roundabout safety benefits; and
- operational and signal warrant analyses.
- Bring visual aids (e.g. videos, posters, VISSIM 2-D or 3-D simulations, and brochures) to help familiarize the public with how to drive through a roundabout.

Some visual aids are available on [GDOT's roundabout website](http://www.dot.ga.gov/DriveSmart/SafetyOperation/Pages/Roundabouts.aspx) (<http://www.dot.ga.gov/DriveSmart/SafetyOperation/Pages/Roundabouts.aspx>) and on [FHWA's roundabout website](http://safety.fhwa.dot.gov/intersection/roundabouts/) (<http://safety.fhwa.dot.gov/intersection/roundabouts/>). Additional information regarding public involvement as well as public education is presented in Section 3.8 of [NCHRP 672](#).

8.3. Design Guidelines

This section presents design guidelines which should be used along with [NCHRP 672](#) for the design of roundabouts. Exhibit 6-1 of [NCHRP 672](#) provides an excellent overview of the design process.

A roundabout should be designed with appropriate geometric features to ensure optimal safety and operational performance for users entering, circulating, and exiting the intersection. The following key principles are taken from Section 6.2 of [NCHRP 672](#):

- provide slow entry speeds and consistent speeds through the roundabout by using deflection;
- provide the appropriate number of lanes and lane assignment to achieve adequate capacity, lane volume balance, and lane continuity;
- provide smooth channelization that is intuitive to drivers and results in vehicles naturally using the intended lanes;
- provide adequate accommodation for design vehicles;
- design to meet the needs of pedestrians and cyclists; and
- provide appropriate sight distance and visibility for driver recognition of the intersection and conflicting users.

Below are a list of additional considerations for multilane roundabouts (See Section 6.5 of [NCHRP 672](#)):

- lane arrangements to allow drivers to select the appropriate lane on entry and navigate through the roundabout without changing lanes;
- alignment of vehicles at the entrance line, into the correct lane within the circulatory roadway;
- accommodation of side-by-side vehicles through the roundabout (e.g., a truck traveling adjacent to a passenger car);
- alignment of the legs to prevent conflicts between exiting and circulating traffic; and
- accommodation for all travel modes.

Satisfying these key principles involves balancing the sometimes competing needs for safety and operational performance. Accordingly, engineers preparing roundabout designs should be familiar with [NCHRP 672](#) and apply a high level of Quality Control/Quality Assurance (QC/QA) throughout the design process.

8.3.1. Review of Construction Plans

GDOT prepared construction plans must be reviewed in accordance with the [Department's QC/QA Manual](#), and construction plans prepared by consultants in accordance with their own approved QC/QA procedures.

If changes are made to the validated concept design that negatively affect geometric and performance checks (e.g. fastest paths, design and check vehicle accommodations), then these checks will be rerun to validate the design in the construction plan set. These geometric and performance checks will be provided in DGN format along with the PFPR/FFPR plan set for review. Submittals can be made by sending an e-mail to RoundABOUTS@dot.ga.gov.

Other performance checks, e.g. intersection sight distance, and OSOW vertical clearance checks, should be completed during the preliminary design phase or any subsequent design phase in which changes are made to the design that affect them.

8.3.2. Design Vehicle

The design vehicle for all roundabouts on state routes and interchange ramp terminals should be an AASHTO WB-67. The roundabout geometry should accommodate the swept path of the design vehicle tires and body and should be evaluated using a CAD-based vehicle turning path program for each of the turning movements. For further information on the selection of a design vehicle including OSOWs, refer to Section 3.2 of this design policy manual. See also Sections 3.5.4.1, 6.2.4, 6.4.7, and 6.5.7 of [NCHRP 672](#).

In addition to accommodating the design vehicle, Buses (BUS-40) in urban areas and single-unit trucks (SU) in rural areas should be accommodated within the circulatory roadway without tracking over the truck apron.

To accommodate oversized vehicles (where needed), roundabouts can be designed with truck blisters behind mountable curb and/or a truck apron behind mountable curb.

8.3.3. Alignment of Approaches

The centerline of the roundabout approaches are often either aligned through the center of the roundabout (or radial) or offset to the left of the roundabout center point (i.e., left offset). The left offset enhances deflection of the entry path. Approach alignments offset to the right of the roundabout center point should be avoided unless other geometric features can be applied to produce acceptable fastest path speeds. An offset to the left is preferred for high speed approaches.

See Section 6.3.2 of [NCHRP 672](#) for a more in-depth discussion on the alignment of approaches.

8.3.4. Splitter Islands

Splitter islands should be incorporated into all roundabouts and should include cut-throughs to accommodate pedestrian traffic.

The total length of the raised island should be at least 100 ft. This minimum may be reduced to 50 ft. on urban roadways with design speeds less than 45 mph. For high speed approaches splitter islands should be lengthened as described in Section 6.8.5.3 of [NCHRP 672](#). See Sections 6.4.1 and 6.5.5 of [NCHRP 672](#) for more information on the design of splitter islands.

8.3.5. Pedestrian Accommodations

Pedestrians should be considered and accommodated at all roundabout intersections. Pedestrian accommodations should include cut-throughs on splitter islands, two-stage perpendicular crossings, curb ramps and accessibility features such as detectable warning surfaces. Pedestrian activated signals should be considered for multi-lane roundabouts with high pedestrian traffic volumes.

Sidewalks should be set back from the edge of the circulatory roadway with a landscape buffer. Landscape buffers should have a minimum width of 2 ft. with 6 ft. being desirable. Stamped and colored concrete should be considered for 2 ft. wide landscape buffers to assist sight-impaired pedestrians.

At single-lane approaches and departures, the pedestrian crossing should be located one car length (approximately 20 ft.) away from the inscribed circle. At multilane approaches and departures, the pedestrian crossing should be located one or two car lengths away from the inscribed circle.

Further information on the design of pedestrian accommodations is provided in Section 6.8.1 of [NCHRP 672](#).

8.3.6. Bicycle Accommodations

Where bicycle lanes are used on approach roadways, they should be terminated in advance of roundabouts using tapers to merge cyclists into traffic for circulation with other vehicles. For bike routes, where cyclists remain within the traffic lane, it can be assumed that cyclists will continue through the roundabout in the travel lane.

At multi-lane and high speed roundabouts, consider providing bicycle ramps to allow bicyclists to exit the roadway onto the sidewalk and travel as pedestrians. Ramps normally should not be used at urban, one-lane roundabouts except where the complexity of the roundabout would make circulating like other vehicles more challenging for bicyclists.

Further information on the design of bicycle accommodations is provided in Section 6.8.2 of [NCHRP 672](#).

8.3.7. Treatments for High Speed Approaches

The primary safety concern in rural locations where approach speeds are high (i.e., ≥ 50 mph) is to make drivers aware of the roundabout with sufficient advance distance to comfortably decelerate to the appropriate speed for entering the roundabout. Where possible, the geometric alignment of approach roadways should be constructed to maximize the visibility of the central island and the shape of the roundabout.

Speed reduction treatments should be used for all high speed approaches. These treatments may include geometric and/or nongeometric techniques. Examples of geometric treatments include the use of horizontal curvature on approaches and the extension of splitter islands upstream of the entry yield line - for a distance equal to the length required to decelerate from the approach

roadway design speed to the entry speed of the roundabout. Examples of nongeometric treatments include the addition of successive sets of rumble strips placed in advance of the roundabout, speed reduction markings placed transversely across travel lanes, advance warning signs supplemented by warning beacons, and landscaping of splitter islands to increase their prominence.

Further information on treatments for high speed approaches is provided in Section 6.8.5 and 7.4.4 of [NCHRP 672](#).

8.3.8. Drainage

Drainage structures should normally be placed on the outer curb line of the roundabout and upstream of crosswalks, but should not be placed in the entry and exit radii of the approaches. Drainage structures located on the outer curb line of the circulatory roadway should be designed to withstand vehicle loading (e.g., [Type E, Standard Drop Inlet with Hood shown on GDOT Standard Drawing 1019A](#)). Maximum gutter spreads should match the requirements for the approach roadways, as outlined in the GDOT manual [Drainage Design for Highways](#).

Refer to Section 6.8.7 of [NCHRP 672](#) for a discussion of vertical alignment considerations, which includes drainage.

8.3.9. Curbing

Concrete curb and gutter with a Type 2 curb face should be used along the outside edge of all roundabouts which includes the entry radius, the circulatory roadway, and the exit radius. For rural roadways it is desirable to extend outside curbing along approaches to the length of the required deceleration distance to the roundabout entry. For outside truck aprons (blisters), concrete curb and gutter with a Type 9 curb face should be used.

A Type 7 curb face should also be used for splitter islands, and a Type 1 curb face used for portions of splitter islands that need to be mountable for accommodation of design/check vehicles. A Type 9 concrete header curb or concrete curb and gutter with a Type 9 curb face, should be used between the truck apron and the circulatory roadway. Type 9 concrete header curb is detailed on [GDOT Construction Standard 9032B](#).

Further information on the principles for using curbs is provided in Sections 6.8.7.4 and 6.8.8.1 of [NCHRP 672](#).

8.3.10. Pavement

Asphalt or dark colored concrete are the recommended materials for the circulatory roadway to differentiate it from the concrete truck apron. A proposed pavement design should be prepared for each roundabout and be submitted for review and approval in accordance with the [GDOT PDP](#).

Further information on the design of pavements is provided in Section 6.8.8 of [NCHRP 672](#).

8.3.11. Staging of Improvements

If capacity analysis demonstrates that a single-lane roundabout is adequate for at least 10 years after the opening year, a single-lane roundabout should be constructed. If a multilane roundabout is required before the design year, the single-lane roundabout should be constructed having the footprint of a multilane roundabout and be designed to be easily retrofitted to a multilane roundabout (See Section 6.12 of [NCHRP 672](#)).

To allow for this future expansion, the right-of-way and geometric needs of both the single-lane and multilane roundabout must be defined. For further information refer to Section 6.12 of [NCHRP 672](#).

8.3.12. Traffic Control Devices

Traffic control devices for roundabouts will be in accordance with the [2009 Manual on Uniform Traffic Control Devices](#). Chapter 7 of [NCHRP 672](#) provides a helpful presentation of the application of traffic control devices to roundabouts.

8.3.13. Landscaping

Landscaping should be installed with the construction of most roundabouts. Landscaping of the central island provides for visual awareness of the roundabout location from a distance. Landscaping in the central island also limits the amount of excess sight distance for drivers to help encourage slower speeds. Consequently, landscaping should adequately block the through sight lines of an approaching driver so that the driver sees the central island rather than the roadway beyond. Landscaping within the central island should discourage pedestrian traffic to and through the central island.

Any landscaping that is provided along the perimeter of the central island should consist of low-lying shrubs, grass or groundcover so that stopping and intersection sight distance requirements are maintained for vehicles. The width of this perimeter central island landscaping should be based on sight distance calculations and be shown on construction plans.

Shrubs and columnar growing species may be appropriate within the inner portion of the central island. Consideration should be given to the size and shape of mature plants.

[GDOT Construction Detail RA-1](#) provides a layout and details that may be used for landscaping a roundabout central island. Landscaping is recommended for all roundabouts and is required where one or more approaches have a design speed greater than or equal to 50 mph. A Right-of-Way Mowing and Maintenance Agreement is required for on-system roundabouts.

Further information on landscaping principles is provided in Chapter 9 of [NCHRP 672](#).

8.3.14. Construction

Construction time and cost can be reduced by constructing a roundabout while maintaining traffic outside the footprint of the roundabout (e.g. a detour). Presented below is one possible sequence for construction where traffic must pass through the work zone.

- (1) Install signing and lighting (signing should initially be covered).
- (2) Maintain traffic on existing roadways. Construct the portion of the roundabout located outside the existing intersection footprint. This should include drainage structures and a portion of the circulatory roadway but not the shoulder outside the circulatory roadway.

Construct temporary pavement outside the final circulatory roadway for maintaining traffic in the next stage.
- (3) Remove covered signage and shift traffic from the existing roadways to the temporary circulatory roadway. The intersection should function as a roundabout, the temporary circulatory roadway should be wide enough to accommodate the design vehicle.

- (4) Construct splitter islands and central island (including the truck apron). Complete the construction of the circulatory roadway and any pavement markings.
- (5) Shift traffic from the temporary circulatory roadway to the final circulatory roadway.
- (6) Remove temporary pavement and construct shoulders. Complete drainage structures and relocate signing to appropriate locations within the islands.

The above is a brief explanation meant to illustrate one possible sequence of construction. Actual staging narratives for construction plans will vary considerably from one project to another, and must be specific to the design and constraints of each project. Further information including other staging sequences is presented in Section 10.3 of [NCHRP 672](#).

8.4. References

8.4.1. Primary References

For the planning and design of roundabouts refer to the most current edition of the following publications.

- [2010 Highway Capacity Manual](#), Transportation Research Board, National Academies of Science, Washington DC, 2010.
- [Highway Capacity Manual, Sixth Edition: A Guide for Multimodal Mobility Analysis \(HCM6\)](#), Transportation Research Board, National Academies of Science, Washington DC, 2016.
- [Recommended Practice for Design and Maintenance of Roadway and Parking Facility Lighting, RP-8-18](#), Illuminating Engineering Society of North America, New York, NY, 2018.
- [Manual on Uniform Traffic Control Devices](#), Federal Highway Administration, US Department of Transportation, 2009.
- [Roundabouts: An Informational Guide, 2nd Edition](#), NCHRP 672, National Cooperative Highway Research Program, Transportation Research Board, National Academies of Science, Washington, DC, 2010.

8.4.2. Additional References

- [Crossing Solutions at Roundabouts and Channelized Turn Lanes for Pedestrians with Vision Disabilities](#), NCHRP Report 674, National Cooperative Highway Research Program, Transportation Research Board, National Academies of Science, Washington, DC, 2011.
- [Guidance Memorandum on Consideration and Implementation of Proven Safety Countermeasures – 5. Roundabouts](#), Federal Highway Administration, US Department of Transportation, July, 1, 2009.
- [Handbook for Designing Roadways for the Aging Population](#), Publication No. FHWA-SA-14-015, Federal Highway Administration, US Department of Transportation, June 2014.
- [Mini-Roundabout Technical Summary](#), Report FHWA-SA-10-007, Federal Highway Administration, US Department of Transportation, Feb. 2010.
- [Pedestrian Access to Modern Roundabouts: Design and Operational Issues for Pedestrians Who are Blind](#), US Access Board.

- [Roundabouts in the United States](#), NCHRP Report 572, National Cooperative Highway Research Program, Transportation Research Board, National Academies of Science, Washington DC, 2007.
- [Roundabout Technical Summary](#), Report FHWA-SA-10-006, Federal Highway Administration, US Department of Transportation, Feb. 2010.
- [Signalized Intersections: An Informational Guide, 2nd Ed.](#), Publication No. FHWA-SA-13-027, Federal Highway Administration, US Department of Transportation, July 2013.

8.5. Definitions

Figures 8.2 and 8.3 illustrate key roundabout physical features and design elements. These figures were modified from the report, [Technical Memorandum: Planning-Level Guidelines for Modern Roundabouts](#) prepared by the Center for Transportation Research and Education at Iowa State University [2008]. Definitions for key terms are provide below each figure and most are taken or adapted from either the above report or [NCHRP 672](#).

8.5.1. Roundabout Physical Features

Roundabout features are described in **Table 8.5.** and depicted below.

Table 8.5. Figure Key Roundabout Features

Feature	Description
Entry	The approaching roadway prior to the circulating roadway and between the right curb face of the approach side of the splitter island. This key roundabout feature, including the width and angle, is the largest determinant of a roundabout's capacity and safety.
Exit	The exiting roadway after the circulating roadway and between the right curb face and the exit side of the splitter island.
Central Island	The raised area in the center of a roundabout, around which traffic circulates. The central island does not necessarily need to be circular in shape.

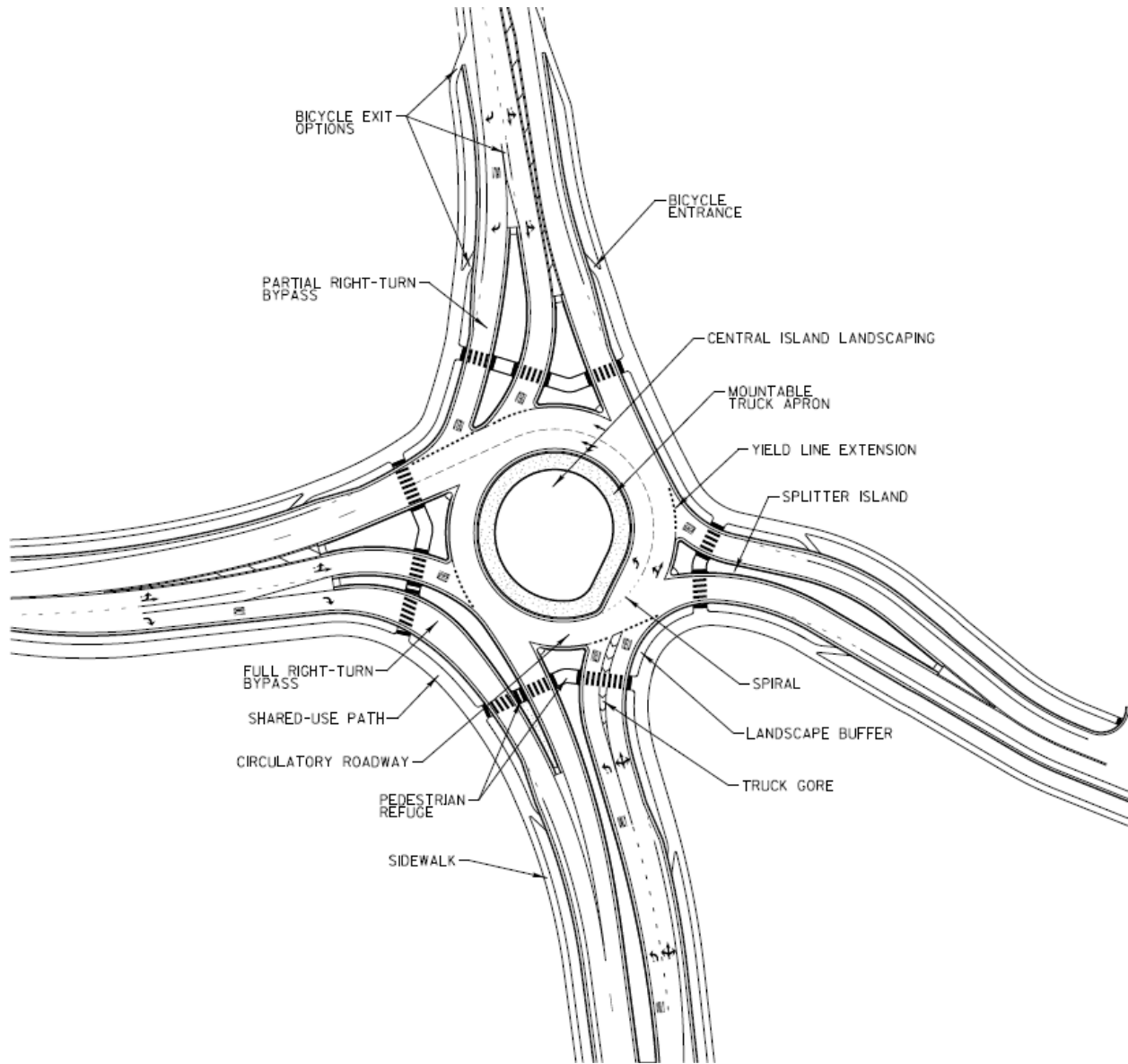

Figure 8.2. Key Roundabout Physical Features

Splitter Island	A raised median on an approach used to separate entering from exiting traffic, deflect and slow entering traffic, and to provide refuge for pedestrians crossing the road in two stages.
Circulatory Roadway	The curved one-way roadway used by vehicles to travel in a counterclockwise fashion around the central island. The width of the circulatory roadway is typically 1.0 to 1.2 times the widest entry width.
Raised Truck Apron	The mountable portion of the central island adjacent to the circulatory roadway. It is required to accommodate the wheel tracking of long or oversized vehicles Oversize/Overweight vehicles (OSOW). It is usually paved with a contrasting color, surface material or surface treatment to delineate the apron from the normal vehicle path.
Edge Line Extension	A pavement marking line of demarcation separating traffic approaching the roundabout from the traffic already in the circulating roadway. The yield point is usually defined by a thick, (typically 18-inch wide), dotted edge line extension pavement marking. The skip pattern is 2-ft./2-ft.
Accessible Pedestrian Crossings	Pedestrian crossings provided at roundabouts must safely and efficiently serve all pedestrians; including the visually impaired, wheelchairs, strollers, and bicycles. Ideally, non-motorized users will be provided the opportunity to cross the street in a two-staged crossing with a refuge cut into the splitter island. The crossing location is set back from the yield line, typically one car length (20 to 25 ft.)
Bicycle Treatments	<p>Bicycle treatments at roundabouts provide bicyclists the option of traveling through the roundabout either by riding in the travel lane as a vehicle, or by exiting the roadway and using the shared-use path, depending on the bicyclist's level of comfort.</p> <p>The entrance and exit ramps should be located at a minimum of 50 ft., from the upstream edge of the crosswalk, and 100 ft. from the yield point of the circulatory roadway to allow the bicyclist an opportunity to transition onto a path away from the circulatory roadway.</p>
Sidewalk / Shared-Use Path	It is common to provide a shared-use path at the perimeter of the roundabout to provide both pedestrians and bicyclists off-road accommodation. Sidewalks circulate a roundabout when bicycle traffic is expected to use the roadway through the roundabout.
Full Right Turn Bypass Lane	Full Right turn bypass lanes allow vehicles to bypass the roundabout and then merge into the exiting stream of traffic. A high right-turn demand when coupled with other approaching traffic may indicate the need for a full bypass lane in order to avoid a wider, faster entry. Full Right turn bypass lanes create an additional conflict for pedestrians and bicyclists and should be avoided, if possible, particularly near schools, senior citizen centers, and similar facilities that serve the most vulnerable roadway users.
Partial Right Turn Bypass Lane	A partial right turn bypass lane with either a curbed or a painted channelization requires approaching vehicles to yield to traffic leaving

	the adjacent exit. This alternative ‘snags’ the right turner from making a through movement while preserving good sight to the left for circulating/exiting traffic. Generally, an intersection angle of 70 degrees or higher is desirable.
Spiral (not to be confused with a highway curve spiral)	A spiral prevents vehicles from becoming trapped on the inside lane and allows them to make the desired exit without changing lanes. A spiral accomplishes this by aiding the development of a lane gain to facilitate the shift of the circulating vehicle as it circulates past an entry that has an exclusive left turn lane.
Boulevard (Landscape Buffer)	Boulevard separation is provided to set apart vehicular and pedestrian traffic and to help direct pedestrians to cross only at the designated crossing locations. Landscaping can also significantly improve intersection aesthetics and contribute to traffic calming provided it is placed outside the required sight limits.

8.5.2. Roundabout Glossary of Terms

Approach Width – the width of the roadway used by approaching traffic upstream of any changes in width associated with the roundabout.

Circulatory Roadway Width – the width between the outer edge of the circulatory roadway and the central island.

Conflict Point – a location where the paths of two vehicles, or a vehicle and a bicycle (or pedestrian), merge, diverge, cross, or queue behind each other. [See Exhibits 5-1 and 5-2 of NCHRP 672 for illustration of vehicle conflict points at 3- and 4-leg roundabouts and a conventional intersection.]

Deflection – the change in trajectory of a vehicle imposed by geometric features of the roadway. Entry deflection helps control vehicle speeds and discourages wrong-way movements on the circulatory roadway. [See Exhibit 6-10 of NCHRP 672 for a comparison on entry alignments with and without deflection.]

Entry Angle - View angle is measured as the angle between a vehicle’s alignment at the entrance line and the sight line required according to intersection sight-distance guidelines. The intersection angle between consecutive entries must not be overly acute in order to allow drivers to comfortably turn their heads to the left to view oncoming traffic from the immediate upstream entry. [See Section 6.7.4 of NCHRP 672 for further guidance.]

Entry Curves – the left-hand edge of the entry curve, where it turns into the circulating roadway, should generally be tangential to the central island.

Entry Flare – the widening of an approach to multiple lanes to provide additional capacity at the yield line and storage. [See Exhibit 1-8(e) of NCHRP 672 for an example of an entry flare and Section 6.5.2 of the same report for further reference.]

Entry Speed – the speed a vehicle is traveling as it crosses the yield line.

Entry Width – the width of the entry where it meets the inscribed diameter, measured perpendicularly from the right edge of the entry to the intersection point of the left edge line and the inscribed circle.

Exit Curves and Tapers – tapering the number of lanes on an exit from two lanes to one lane allows for additional roundabout capacity without extensive mid-block widening. Exit radii should be in the range of 200-ft. to 400-ft. Design exit tapers from roundabouts based on the anticipated in-lane exiting speed which is typically in the range of 15 to 25 mph, not the fastest path. Merging taper rates should be typically 20:1 to 30:1

Fastest Path – The fastest path allowed by the approach and roundabout geometry determines the negotiation speed for that particular movement into, through, and exiting the roundabout. It is the smoothest, flattest path possible for a single vehicle, in the absence of other traffic and ignoring all lane markings. [See Section 6.7.1 of NCHRP 672 for a detailed presentation. Exhibit 6-46 for of NCHRP 672 illustrates the five critical path radii that must be checked for each approach.]

Geometric Delay – the delay caused by the alignment of the lane or the path taken by the vehicle on a roadway or through an intersection. [See Section 4.5.8 of NCHRP 672 for further reference.]

Inscribed Circle Diameter – the basic parameter used to define the size of a roundabout, measured between the outer edges of the circulatory roadway. It is the diameter of the largest circle that can be inscribed within the outline of the intersection.

Locking – stoppage of traffic on the circulatory roadway caused by queuing backing into the roundabout from one of the exits, resulting in traffic being unable to enter or circulate.

Natural Path – The path an approaching vehicle will take through a multi-lane roundabout, assuming traffic in all lanes. The speed and orientation of the vehicle at the yield line determines the natural path. [See Section 6.7.2 of NCHRP 672 for further reference.]

Path Alignment – a roundabout should naturally align entering lanes into their appropriate lane within the circulatory roadway and then to the appropriate lanes on the exit. [See Sections 3.5.4.2 and 6.2.3 of NCHRP 672 for further reference.]

Roundabout Capacity – the maximum number of entering vehicles that can be reasonably expected to be served by a roundabout during a specified time period.

Vehicle Path Overlap - Path overlap occurs on multi-lane roundabouts when the natural path through the roundabout of one vehicle overlaps that of another vehicle. Occurs most commonly on the approach when a vehicle in the right lane cuts off a vehicle in the left lane as the vehicle enters the circulating lane. [See Exhibits 6-28 and 6-33 of NCHRP 672 for illustrations of entry and exit vehicle path overlap, and Section 6.2.3 of the same report for a discussion of appropriate path alignment.]

Chapter 9. Complete Streets Design Policy - Contents

Chapter 9. Complete Streets Design Policy - Contents	9-i
9.1. Overview	9-1
9.1.1. Principles	9-2
9.1.2. References	9-3
9.1.3. Definition of Accommodation	9-5
9.2. Typical Users & Needs	9-6
9.2.1. Pedestrians	9-6
9.2.2. Bicyclists	9-6
9.2.3. Transit Users	9-7
9.2.4. Needs and Volumes	9-7
9.3. User Networks	9-7
9.3.1. Pedestrian Networks	9-7
9.3.2. Bicycle Networks	9-10
9.3.3. Transit Networks	9-15
9.4. Warrants for Accommodation	9-16
9.4.1. Pedestrian Warrants	9-16
9.4.2. Bicycle Warrants	9-17
9.4.3. Transit Warrants	9-18
9.4.4. Exclusions	9-18
9.5. Design of Accommodations	9-19
9.5.1. Pedestrian Accommodation Design	9-19
9.5.2. Bicycle Accommodation Design	9-28
9.5.3. Transit Accommodation Design	9-35
9.6. Acknowledgements	9-35

Chapter 9. Complete Streets Design Policy

9.1. Overview

It is the policy of the Georgia Department of Transportation (GDOT) to routinely incorporate bicycle, pedestrian, and transit accommodations into transportation infrastructure projects as a means for improving mobility, access, and safety for the traveling public. Accordingly, GDOT coordinates with local governments and planning organizations to ensure that bicycle, pedestrian, and transit needs are addressed, beginning with system planning and continuing through design, construction, maintenance and operations. This is the “Complete Streets” approach for promoting pedestrian, bicycle, and transit travel in the State of Georgia.

The concept of Complete Streets emphasizes safety, mobility, and accessibility for all modes of travel and for individuals of all ages and abilities. The design of transportation projects for multiple travel modes requires balancing the needs of each mode. This “balance” must be accomplished in a context sensitive manner appropriate to the type of roadway and the conditions within the project and surrounding area.

This policy is consistent with the following statement taken from the [U.S. Department of Transportation, Policy Statement on Bicycle and Pedestrian Accommodation Regulations and Recommendations](#):

The DOT policy is to incorporate safe and convenient walking and bicycling facilities into transportation projects. Every transportation agency, including DOT, has the responsibility to improve conditions and opportunities for walking and bicycling and to integrate walking and bicycling into their transportation systems. Because of the numerous individual and community benefits that walking and bicycling provide — including health, safety, environmental, transportation, and quality of life — transportation agencies are encouraged to go beyond minimum standards to provide safe and convenient facilities for these modes.

GDOT’s primary strategy for implementing Complete Streets is to incorporate bicycle, pedestrian, and transit accommodations into roadway construction and maintenance projects. Local governments and planning agencies can also implement Complete Streets by partnering with GDOT, and by initiating and managing their own locally-funded projects and programs. GDOT assists local governments and metropolitan planning organizations (MPOs) by administering special programs such as Transportation Alternatives Program (TAP), [Livable Centers Initiative](#) (LCI), or federally funded programs. In addition, GDOT provides oversight to the State’s Passenger Rail programs¹ to promote motorized transit alternatives such as bus, van-pool, and rail travel.

Altogether, these efforts advance an incremental approach for developing local, regional, and statewide multimodal transportation networks. This approach also supports a primary objective of

¹ The GDOT [Transit Program](#) administers federal and state funds, when available, which provide capital, planning and operating assistance for transit systems as well as providing planning assistance to all 15 MPOs in Georgia. The GDOT Georgia Rail Passenger Program (GRPP) provides a comprehensive plan for both commuter and intercity train travel within Georgia.

the Statewide Strategic Transportation Plan to increase the overall health and prosperity of citizens and businesses that use and depend on Georgia's transportation system.

Pedestrians and bicyclist are allowed on nearly every roadway in Georgia, with the exception of those routes with Full-Control-Access such as interstate highways and major freeways (see Chapter 3.5 Establishment of Access Control for definition of types of access control). This policy is consistent with [OCGA § 32-6-113](#) (ability to design limited-access roadways) and [OCGA § 40-6-51](#) (regulation of controlled-access roadways within jurisdiction). Typical signage used to regulate pedestrians and bicycles on Full-Control-Access facilities is shown below in Figure 9.1.



Figure 9.1. Signage regulating pedestrian and bicycle usage on Full-Access-Control Roadways

9.1.1. Principles

The following principles form a basis for the bicycle and pedestrian accommodation policies presented in the remainder of this chapter:

1. Accommodations for bicycles and pedestrians should be integrated into roadway construction projects through design features appropriate to the context and function of the transportation facility.
2. The design and construction of new facilities should anticipate likely demand for bicycling and pedestrian facilities within the design life of the facility.
3. The design of intersections and interchanges should accommodate bicyclists and pedestrians in a manner that addresses the need to safely cross roadways, as well as to travel along them.

4. The design of new and reconstructed roadways should not preclude the future accommodation of bicyclists and pedestrians along and across corridors.
5. While it is not the intent of maintenance resurfacing to expand existing facilities, opportunities to provide facilities or to enhance safety for pedestrians and bicyclists should be considered during the development of these projects.

The following principles form a basis for the transit accommodation policies presented in the remainder of this chapter:

1. Accommodations for transit should be integrated into roadway construction projects through design features appropriate for the context and function of the roadway, and associated transit facility (e.g., transit stops, stations, or park-and-ride lots).
2. The design of roadways and intersections should address the need of pedestrians to safely walk along and across roadways, to access nearby transit facilities.
3. The design of new and reconstructed roadways should not preclude the accommodation of transit facilities (e.g., for light rail, street cars, and bus rapid transit) *planned and funded* for construction within the design life of the roadway project.

9.1.2. References

Planning References

Refer to the most current edition of the following publications for *planning* considerations related to pedestrian, bicycle, and transit facilities:

- [Georgia Guidebook for Pedestrian Planning](#), GDOT, 2006.
- [Georgia Bicycle and Pedestrian Safety Action Plan](#), GDOT, Governor's Office of Highway Safety (GOHS).
- [Pedestrian Safety Guide for Transit Agencies](#). FHWA, 2008.

Consult adopted state, regional, and local [planning documents](#) to help identify existing and planned pedestrian, bicycle, and transit facilities. Below are the major types of planning documents commonly adopted by local governments, MPOs, and regional commissions.

- State and regional long range transportation plans.
- City/County comprehensive transportation plans.
- City/County bicycle master plans.
- City/County pedestrian master plans.
- City/County unified public work plans.
- City/County transit development plans.
- City/County transit improvement plans.
- Statewide transit improvement plans.

Where used to evaluate warrants (refer to **Section 9.4 Warrants for Accommodation** of this manual), information from the above planning documents should be verified with the organization originating the document. The GDOT State Bicycle and Pedestrian Coordinator should be consulted in the event that planning documents show conflicting information about a specific facility

and to verify that information shown is current and correct. Corridor or facility planning studies may also be considered.

Design References

Refer to the most current edition of the following publications for the *design* of pedestrian, bicycle, and transit accommodations:

- [Accessible Public Rights-of-Way, Planning and Designing for Alterations](#), Public Rights-of-Way Access Advisory Committee, 2007.
- [Accessible Sidewalks and Street Crossings – An Informational Guide](#), FHWA, 2004.
- [Achieving Multimodal Networks Applying Design Flexibility & Reducing Conflicts](#), FHWA, 2016.
- [Bikeway Selection Guide](#), FHWA, 2019.
- [Context Sensitive Design Manual](#), GDOT, 2006.
- [Designing Sidewalks and Trails for Access, Part II of II: Best Practices Design Guide](#), FHWA, 2001. (Note: web HTML version incorporates corrections in the [errata sheet](#).)
- [Designing Walkable Urban Thoroughfares: A Context Sensitive Approach](#), Institute of Transportation Engineers (ITE) and Congress for the New Urbanization (CNU), 2010.
- FHWA Bicycle & Pedestrian Program - Design Guidelines web page, Federal Highway Association (FHWA).
http://www.fhwa.dot.gov/environment/bicycle_pedestrian/guidance/design_guidance/
- [Guide for Geometric Design of Transit Facilities on Highways and Streets](#), AASHTO, 2014.
- [Guide for High-Occupancy Vehicle \(HOV\) Facilities](#), AASHTO, 2004.
- [Guide for the Development of Bicycle Facilities](#), AASHTO, 2012.
- [Guide for the Planning, Design, and Operation of Pedestrian Facilities](#), American Association of State Highway and Transportation Officials (AASHTO), 2004.
- [Highway Capacity Manual 2010 \(HCM2010\)](#), TRB, 2010.
- [Manual on Uniform Traffic Control Devices \(MUTCD\)](#), FHWA, 2009.
- [Pedestrian and Streetscape Guide](#), GDOT, 2003.
- [Proposed Guidelines for Public Rights-of-Way \(PROWAG\)](#)², United States Access Board, 2011.

² The Americans with Disabilities Act (ADA) was enacted by the U.S. Congress and signed into law on July 26, 1990, and later amended with changes effective January 1, 2009. ADA design guidelines for accessible buildings and facilities are published in the ADA Accessibility Guidelines (ADAAG). ADA design guidelines for accessible public rights-of-way are published in the U.S. Access Board [Proposed Accessibility Guidelines for Pedestrian Facilities in the Public Right-of-Way \(PROWAG\)](#).

- [Safety Effects of Marked Versus Unmarked Crosswalks at Uncontrolled Locations](#), FHWA, 2005.
- [Separated Bike Lane Planning and Design Guide](#), FHWA, 2015.
- [Urban Bikeway Design Guide](#), National Association of City Transportation Officials (NATCO). (Refer to the FHWA document [Bicycle Facilities and the Manual on Uniform Traffic Control Devices](#) for the status of specific bicycle facilities in FHWA's MUTCD.)

Additional References

- The following publications may also be helpful references: [Improving Pedestrian Safety at Unsignalized Crossings \(TCRP 112/NCHRP 562\)](#), Transit Cooperative Research program (TCRP) and National Cooperative Research Program (NCHRP), 2006.
- Local Street Design Guides (where applicable).
- [Management and Design Guidelines for the Regional Thoroughfare Network](#), Atlanta Regional Commission (ARC).
- [Medians and Pedestrian Crossing Islands in Urban and Suburban Areas](#), FHWA Office of Safety, Proven Safety Countermeasures.
- [Pedestrian Hybrid Beacon](#), FHWA Office of Safety, Proven Safety Countermeasures.
- [Urban Street Design Guide](#), NATCO, 2013.
- [Safe Route to Transit](#), Pedestrians Educating Drivers on Safety (PEDS), 2014

9.1.3. Definition of Accommodation

An accommodation is here defined as any facility, design feature, operational change, or maintenance activity that provides or improves either non-motorized and/or transit travel. The type of accommodation will vary by location and the needs of expected users, but the safety and accessibility of all modes should be considered for all projects where these modes are allowed.

Commonly applied non-motorized user accommodations include sidewalks, curb ramps, pedestrian crossings, bicycle lanes, bikeable shoulders, shared-use paths, pedestrian activated signals, and midblock treatments such as marked crosswalks, median islands, signs, lighting, and accessibility features; and/or other treatments as necessary such as landscaping decisions.

Transit accommodations address pedestrian access to and from transit stops, stations and park and ride lots as well as accommodations for transit vehicles accessing these facilities and traveling along the corridor. Commonly applied accommodations for users include sidewalks, crosswalks, pedestrian push-buttons and signal heads etc... Examples of transit accommodations at bus stops include loading pads and pull-outs. A wide range of transit accommodations are described in Toolkit 9 of the GDOT *Pedestrian Streetscape Guide*, Chapter 9 of the ITE publication *Designing Walkable Urban Thoroughfares: A Context Sensitive Approach*, the AASHTO *Guide for Geometric Design of Transit Facilities on Highways and Streets*, and the PEDS *Safe Routes to Transit*.

9.2. Typical Users & Needs

The selection and design of accommodations require a clear understanding of the users to be benefited. Organizations in Georgia which promote [pedestrian](#), [bicycle](#) and [transit](#) modes of travel are helpful resources for understanding these users and their needs.

Pedestrians and bicyclists are often grouped together and referred to as non-motorized users. Both user groups generally travel at the far right or alongside the roadway, are generally slower than adjacent motor vehicles, and are more influenced by their immediate surroundings. Since both non-motorized modes travel under their own power and are more exposed to the elements, both often prefer direct routes or shortcuts to minimize their effort and time.

Most transit users access transit facilities as pedestrians or bicyclists and therefore have needs that are very similar to those of non-motorized users. Other transit users access transit via other transit or drop off from personal vehicles.

9.2.1. Pedestrians

A pedestrian is defined as a person afoot. This includes children, senior citizens, and people with physical disabilities; these groups may require additional considerations. Pedestrians also include individuals in wheel chairs (motorized or non-motorized) and on skates and skateboards.

Most transportation trips begin or end with walking. Many pedestrians choose to walk for convenience, personal health, or out of necessity. They often prefer greater separation from the roadway, require additional time to cross roadways, and are the most vulnerable of all roadway users. In addition, pedestrians will often seek to minimize travel distance, choosing direct routes and shortcuts even when facilities are not provided. Walking trips are often combined with transit for traveling longer distances; making accessibility to transit stops and stations an important consideration.

In urban areas, walking trips are often combined with private motor vehicle trips. In this case, people often park once and then walk between stores, restaurants and other facilities/services.

9.2.2. Bicyclists

Bicycling trips serve both utilitarian and recreational purposes, often in the same trip. Utilitarian trips are trips that are a necessary part of a person's daily activity such as commuting to work, shopping or errands, or taking a child to school. Recreational trips are usually discretionary trips made for exercise and/or leisure.

Rider age and skill level vary considerably. Utilitarian bicyclists are generally more experienced and confident and will typically choose whichever roadway (or off-road facility) provides for the most direct, safe and comfortable travel to their destinations. Recreational bicyclists are generally younger and/or less experienced and will typically choose routes for comfort or scenery, feel more comfortable on lower-speed and lower-volume roadways, and prefer separated or delineated bicycle facilities. Children have a wide range of skills and cognitive ability and will typically travel only on separated facilities and very low-volume, low-speed residential streets. Where allowed by local government ordinance or resolution, children below the age of 12 may also ride on sidewalks. See [OCGA § 40-6-144](#) for further explanation.

Bicyclists utilize public roadways for most trips and are therefore subject to vehicular laws. Therefore, the bicycle facility should be designed to encourage bicycling behavior that is as predictable as possible when interacting with motor vehicle traffic.

9.2.3. Transit Users

Transit serves a vital transportation function by providing people with freedom of movement and access to employment, schools, community and recreational facilities, medical care, shopping centers, and to other communities. Transit directly benefits those who choose this form of travel, as well as those who have no other choice or means of travel. Transit also benefits motor vehicle users by helping to reduce congestion on roadway networks.

A vital part of the success of a transit system depends on the availability of safe and easy access to transit stations, stops and park-and-ride facilities. Accordingly, transit user accommodations along and across streets served by transit (and on streets that lead to transit corridors) should provide safe and convenient pedestrian access to and from these facilities. Users also commonly access transit by bicycle, car and taxi, as well as other modes of transit.

9.2.4. Needs and Volumes

The degree of non-motorized/transit use and their needs should be determined during the project planning or concept development phases. Defining usage and needs will often require local input and can often be accomplished during the initial concept meeting, by reconnaissance of the project area, and/or at meetings with local officials and stakeholders. Public Information Open House (PIOH) meetings are also a useful venue for obtaining this type of information.

Planning studies for bicycle, pedestrian, and transit travel normally consider the number of users, their typical needs, and significant barriers to travel. This includes measuring current and projecting future travel, evaluating existing conditions, and identifying constraints and opportunities. For bicycle and pedestrian travel, typical planning tools may include non-motorized traffic counts, Bicycle, Pedestrian and Transit Level of Service formulas (refer to HCM2010), Latent Demand (i.e., potential demand) Scores, user surveys, information from transit service providers, and public input. These tools all help establish expected level of usage, destinations, and facility needs above the most basic routine project accommodations.

For transit within urbanized areas; applicable MPOs, regional commissions, and local governments should be contacted to identify specific transit agency(s) providing services on or near the project alignment. Transit agencies identified through this coordination should then be contacted to verify the location of routes and facilities.

The findings of investigations relating to non-motorized and transit users should be documented in the concept report. These findings may be qualitative in nature, but must be sufficient to evaluate the warrants presented in Section 9.4 of this chapter. If the project is expected to adversely impact existing bicycle, pedestrian or transit accommodations, these impacts should be noted.

9.3. User Networks

9.3.1. Pedestrian Networks

Pedestrian networks and associated facilities provide access between local destinations within neighborhoods, towns, and cities. Individual pedestrian networks are interconnected by means of

transit, bicycle, and motor vehicle networks to allow for travel between these areas. Facilities that comprise these networks commonly include: sidewalks, crosswalks, shared-use paths, pedestrian underpasses and overpasses, and wide shoulders or sidewalks in rural areas.

Well-developed pedestrian networks provide continuous, direct routes and convenient connections between destinations, such as homes, schools, shopping areas, public services, recreational facilities, and transit. These types of destinations are more densely distributed in urban areas.

Many regional commissions, MPOs, and local governments have adopted plans for pedestrian networks. An example is provided as **Figure 9.2 [Pedestrian Network Map for Gainesville – Hall MPO \(2006\)](#)**. Refer to the [Gainesville–Hall MPO Bicycle and Pedestrian Plan](#) for more information on this network. Where available, such maps should be consulted in order to evaluate the pedestrian warrants presented in **Section 9.4.1 Pedestrian Warrants** of this Manual. The applicable local government, MPO or regional commission which prepared the map may be contacted to verify the location and intended forms of pedestrian accommodation. For most urban areas, maps will not be available. Consequently, the need for pedestrian accommodations should always consider local and projected conditions along and near the corridor being improved.

The GDOT State Bicycle and Pedestrian Coordinator (within the Safety Unit of the GDOT Office of Traffic Operations) may be consulted with any questions.

Urban areas are classified by the US Bureau of the Census as either “urbanized areas”, “urban cluster areas”, or rural areas. The boundaries for urbanized areas and urban cluster areas are shown on Urban Area Boundary Maps on the GDOT web page [Statewide Functional Classification & Urban Area Boundary Update](#). Please see the embedded links for the Georgia [MPO’s](#) and [regional commissions](#). These areas are defined below.

- **Urbanized Area:** an area with a population of more than 50,000. There are 15 urbanized areas within Georgia, each corresponding to one of Georgia’s 15 [MPOs](#).
- **Urban Cluster area:** is an area with a population between 2,500 and 49,999. For planning purposes, urban cluster areas are represented by one of Georgia’s 12 [regional commissions](#).
- **Rural Area:** an area having a population of less than 50,000. Rural areas are represented by one of the 12 regional commissions. The rural area of Georgia includes everything outside of urbanized and urban cluster areas.

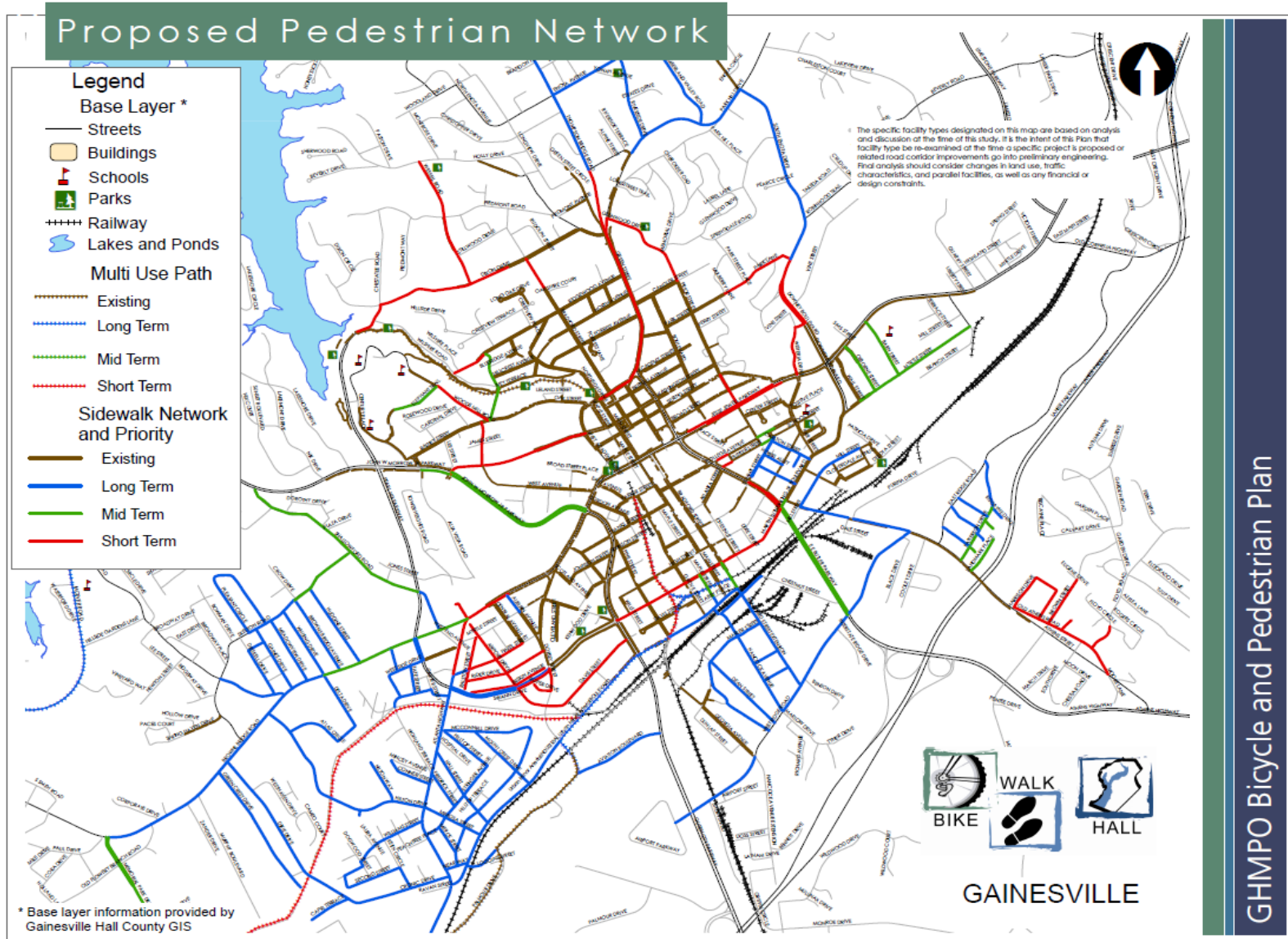

Figure 9.2. Pedestrian Network Map for Gainesville-Hall MPO (2006).

9.3.2. Bicycle Networks

Bicycle networks include roads of all functional classes, as well as off-road bikeways.

Individual networks have been defined by the GDOT, local governments, MPOs, and regional commissions to facilitate bicycle travel within urban and rural areas, and to connect metropolitan areas to regional destinations. Metropolitan and regional destinations include those of important scenic, historic, cultural, recreational, commercial, educational, and employment value as well as transit facilities. These individual bicycle networks are often comprised of many individual bicycle routes.

A state-wide network is formed by linking local/regional bicycle networks to the State of Georgia Bicycle network. This state-wide network is illustrated on **Figure 9.4 Local, Regional, State and U.S. Bicycle Routes in Georgia**. The State of Georgia Bicycle Network is shown in **Figure 9.5 State of Georgia Bicycle Network**³.

Bicycle Routes

A bicycle route is any road, street, path, or way which is specifically prioritized by a jurisdictional authority for bicycle travel. These routes are often *identified* in planning studies, and so there may or may not be a physical bicycle facility present. Although specific roadways are designated as preferred routes for bicyclists, bicyclists are allowed to ride on any road legally open to bicycles - regardless of the presence or absence of physical bicycle accommodations or designations. Photographs showing examples of designated bicycle routes are provided in **Figure 9.3 Examples of Designated Bicycle Routes**.

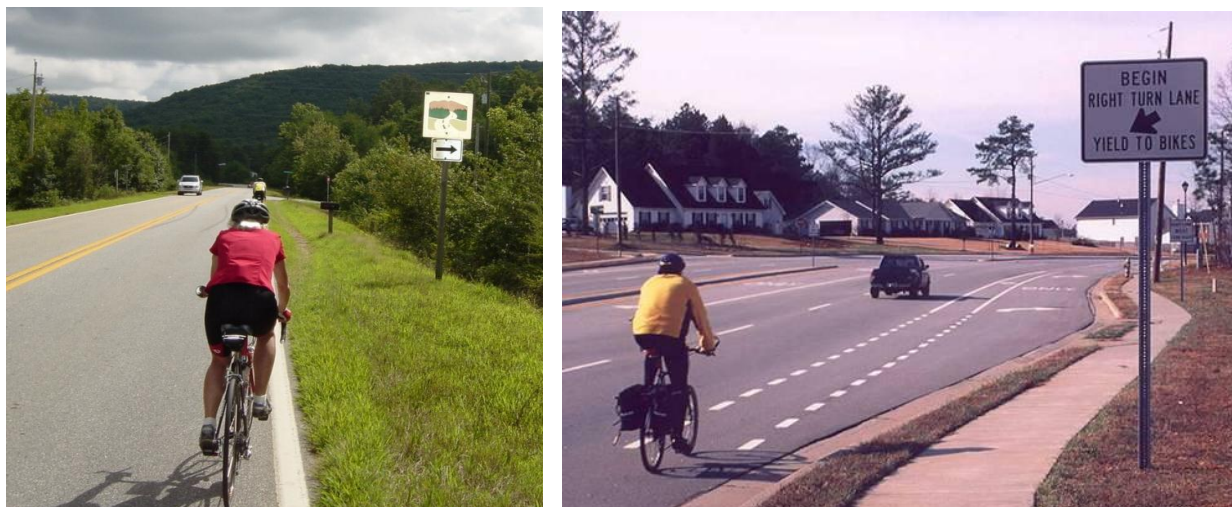

a) Bicycle route, Scenic Byway, N. Georgia; b) Bicycle lane, Sugarloaf Parkway, Gwinnett County

Figure 9.3. Examples of Designated Bicycle Routes.

³ For more information regarding the Georgia State Bicycle Network refer to the GDOT report, *Georgia Bicycle and Pedestrian Plan: Statewide Route Network*, 1998.

Georgia Statewide Bicycle Route Network
DRAFT April 2011

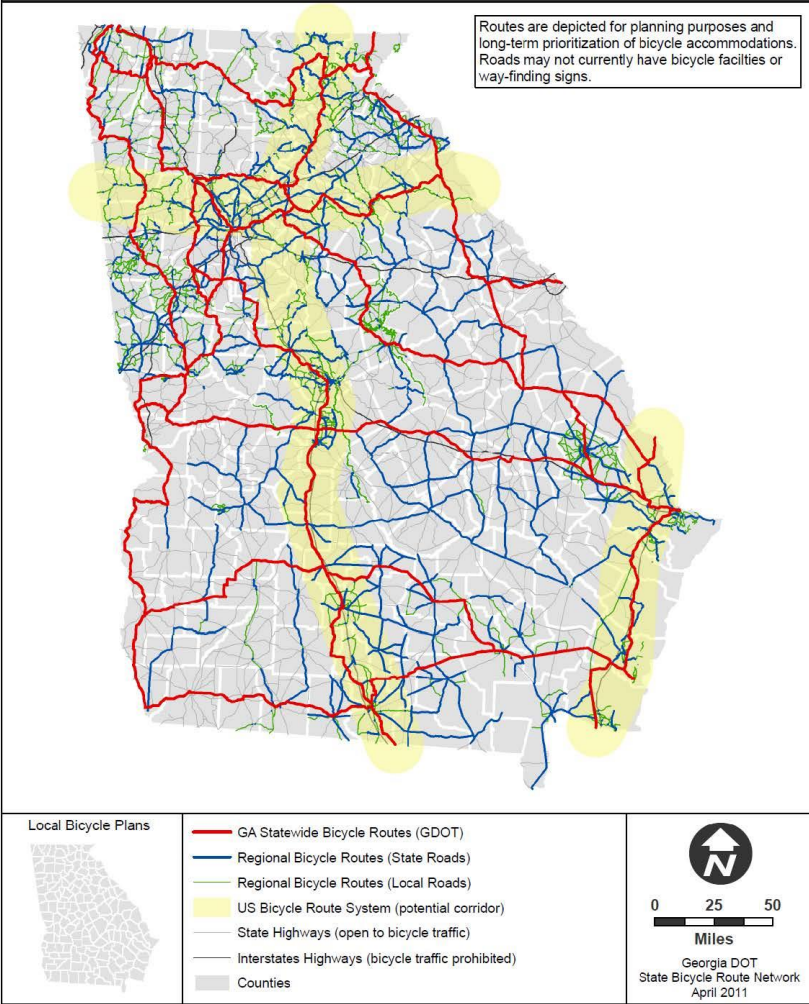

Figure 9.4 Local, Regional, State and U.S. Bicycle Routes in Georgia

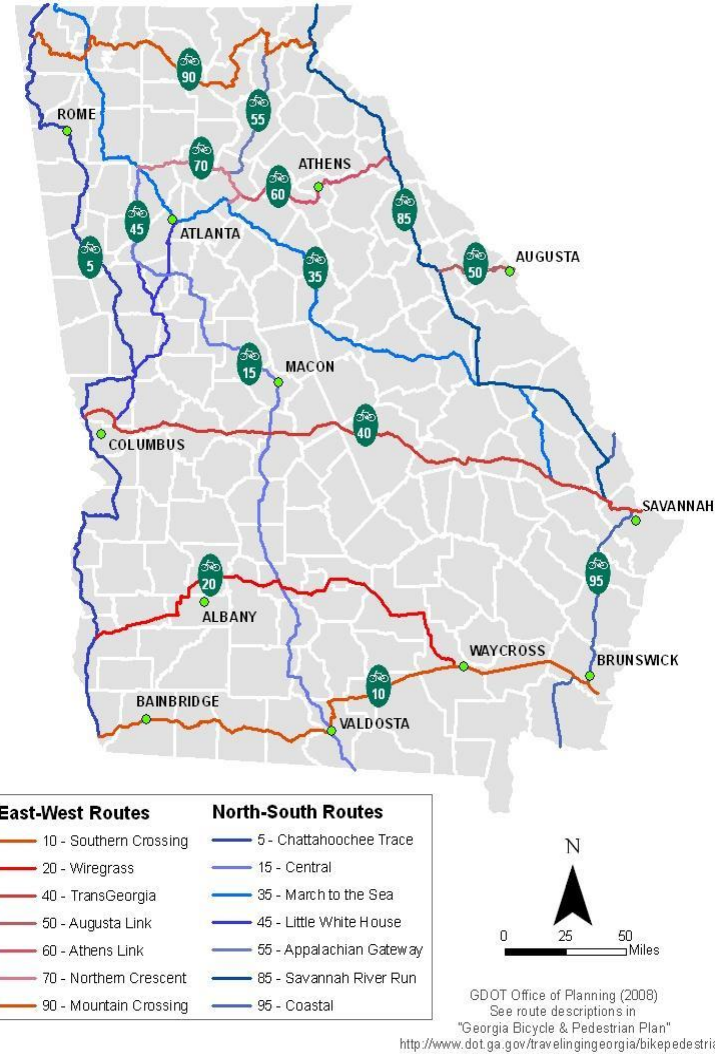

Figure 9.5 State of Georgia Bicycle Network (1997).

Local and Regional Bicycle Networks

Many regional commissions, MPOs, and local governments have developed bicycle networks based on regional or local planning studies. An example of a regional commission network (which includes existing and planned bikeways) is provided in **Figure 9.6 Atlanta Regional Commission (ARC) Bicycle Network Recommendations**. Refer to the ARC planning document, [Atlanta Region Bicycle Transportation and Pedestrian Walkways Plan](#) for more information on this network. Many cities and counties have also adopted bicycle or comprehensive transportation plans; these plans often include one or more bicycle network maps.

Maps showing bicycle routes are commonly available on web sites for these organizations. These maps where available must be consulted to evaluate the bicycle warrants presented in **Section 9.4.2 Bicycle Warrants** of this manual. Prior to the selection and design of accommodations for a bicycle route, the local government, MPO or regional commission which prepared the map should be contacted to verify that the map is current and correctly shows the route alignment. The GDOT State Bicycle and Pedestrian Coordinator can be consulted with any questions, and should be consulted if maps show conflicting information.

State of Georgia Bicycle Network

The Georgia DOT has developed a network of cross-state bicycle routes to facilitate long-distance bicycle travel in Georgia (see **Figure 9.5, State of Georgia Bicycle Network**). These routes consist primarily (where facilities are present) of on-road facilities, such as paved shoulders and bicycle lanes, and wayfinding or cautionary signs. Route selection considers the population of the areas connected rather than populations along the actual route. They support natural connections between adjoining states; link urban areas, transportation hubs, and major attractions; and provide access to scenic, cultural, historical, and recreational destinations. Detailed maps for these routes are available at the following URL: <http://www.dot.ga.gov/DriveSmart/Travel/Pages/BikePed.aspx>

Routes identified as part of the State of Georgia Bicycle Network shall, at a minimum, comply with the basic requirements outlined below:

- All long-distance bicycle routes will meet the criteria for an approved numbered bicycle route system established by the American Association of State Highway and Transportation Officials (AASHTO), Manual on Uniform Traffic Control Devices (MUTCD), and GDOT guidelines;
- Georgia state bicycle routes will be coordinated with neighboring states to ensure consistency with regional or U.S. Bicycle Route networks and allow for interstate bicycle travel; and
- The addition of accommodations along long-distance bicycle routes should include the installation of bicycle route number signs and wayfinding or cautionary signs at appropriate locations.

U.S. Bicycle Route System

The goal of the U.S. Bicycle Route System is to facilitate travel between the states through a network of numbered interstate bicycle routes (refer to the AASHTO Purpose and Policy, U.S. Numbered Bicycle Routes). This initiative will help achieve the following two goals identified in the [Georgia Bicycle and Pedestrian Plan](#):

- to develop a transportation network of primary bicycle routes throughout the state to provide connectivity for intrastate and interstate bicycle travel; and
- to promote establishment of U.S. numbered bicycle routes in Georgia as part of a national network of bicycle routes.

USBR 21, which connects Atlanta to Chattanooga, was approved by AASHTO in the fall of 2015. Three other initial 50-mile wide corridors are being considered for establishment of U.S. Bicycle Routes in Georgia:

- USBR 1, which travels from Camden County (Florida Border) to Chatham County (South Carolina border) along the coast;
- USBR 15, which travels from Lowndes County (Florida border) to the North Carolina border through the center of the state;
- USBR 84, which travels from the South Carolina border to the Alabama border through the Piedmont Region and Atlanta area;

Detailed routes (turn-by-turn) within these three corridors have yet to be defined. Accordingly, GDOT is working with the regional commissions, MPOs, local governments, bicycling interest groups, and managers of bicycle facilities to assess and identify of detailed routes along these corridors.

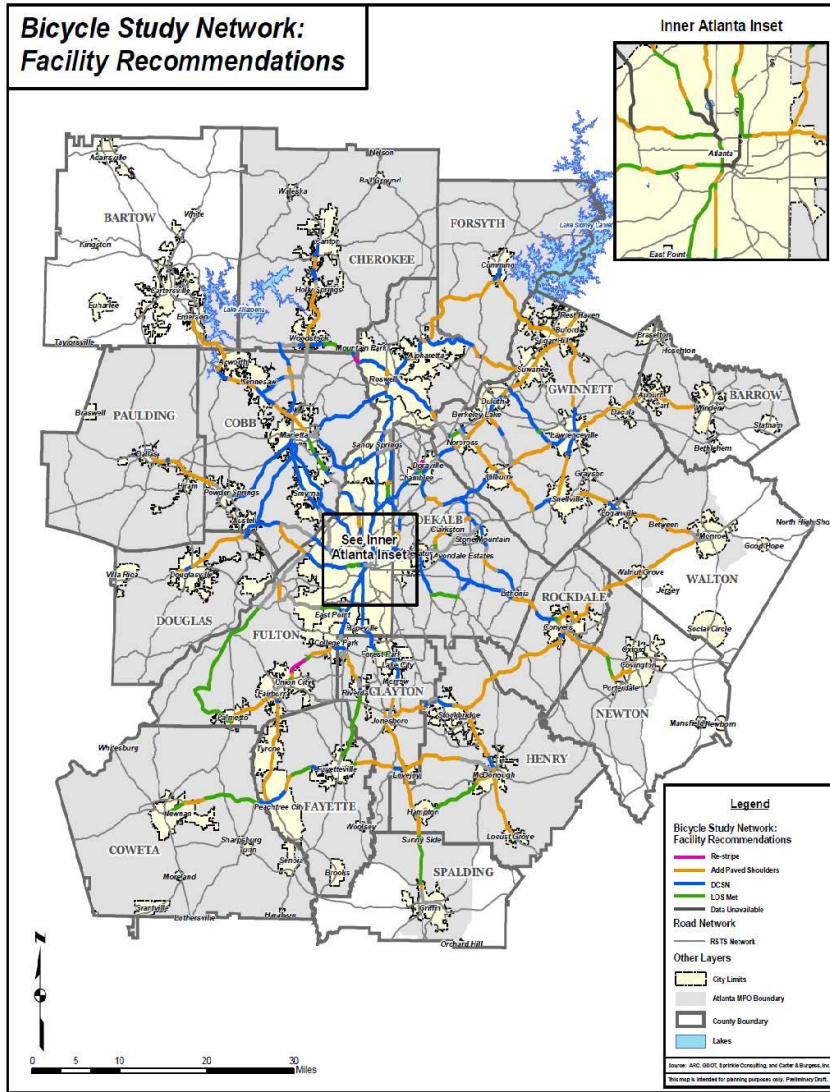

Figure 9.6. Atlanta Regional Commission (ARC) Bicycle Network Recommendations.

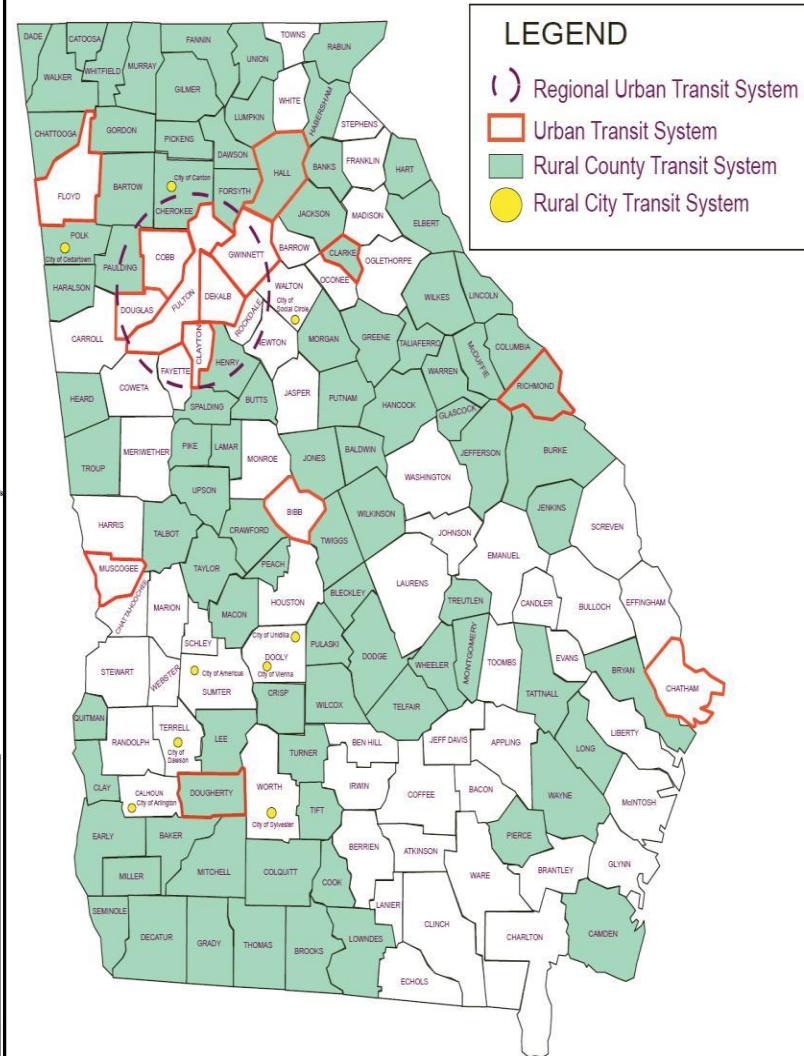

Figure 9.7. Georgia Map Showing Counties with Transit Systems.
 Note: Clayton County now has a rural county transit system.

9.3.3. Transit Networks

There are a large number of transit agencies in Georgia which form a broad network of fixed route bus, paratransit, and rail services. This network includes several types of transit service (see below) as part of 15 urban networks and 111 public transportation programs which cover more than half of Georgia counties and all 15 MPOs.

Rural transit networks are more numerous than urban transit networks, but urban transit networks carry a larger number of people. **Figure 9.7 Georgia Map Showing Counties with Transit Systems** is available from the GDOT Intermodal Office Transit Program and can be used to identify counties which have fixed-route transit systems. Maps showing existing and planned transit networks should be available from [transit service providers](#), local governments, MPOs, and regional commissions. A GDOT [Planner](#) can be contacted to help locate [transit](#) maps which apply to a specific project corridor. For the Atlanta region, refer to the [ARC Strategic Regional Thoroughfare Plan for planned transit routes](#).

Types of Transit Service

Seven basic types of transit service commonly found in urban and rural transit systems are defined below, the last four of which are high-capacity type transit systems.

Paratransit – regulatory service that must accompany fixed route bus service for qualified disabled persons; provides demand-response type services. This form of transit is operated within $\frac{3}{4}$ of a mile of fixed routes. Trips are utilizing smaller vehicles such as vans, shuttles and small buses. Accommodations for paratransit are not normally considered when designing roadway infrastructure projects.

Local Bus – bus service operating at a fixed frequency and serving designated stops along a fixed route. Local bus service usually operates within the normal travel lanes of the urban roadway network. [MARTA](#), [Cobb County Community Transit](#), and [Chatham Area Transit](#) are examples of transit agencies which provide local bus service. Although classified as fixed-route transit, local and express bus routes are more frequently subject to change than other forms of transit.

Express Bus – similar to local bus but with fewer stops. Express buses normally operate during peak travel periods and include fewer but longer routes than local bus. [Cobb Community Transit](#), [Gwinnett County Transit](#), and [GRTA](#) are examples of transit agencies which provide express bus service.

Bus Rapid Transit (BRT) – enhanced bus service with limited stops, and with technology which helps speed up travel. BRT operates in shared (within designated lanes) or exclusive right-of-way along urban roadways and freeways.

Rapid Transit Rail – passenger transit service which operates in a separate right-of-way within an inner-urban area. Rapid transit rail typically carry more passengers than light rail but fewer than commuter rail. MARTA is an example of a transit agency which provides Rapid Transit Rail services. MARTA is classified as a Heavy Rail system, which refers to the large number of passengers the trains can carry, and not the weight.

Commuter Rail – passenger rail transport service that primarily operates between a city center and the middle to outer suburbs (beyond about 10 miles), commuter towns, or other locations

that draw large numbers of commuters. Commuter rail often shares tracks and technology with a mainline railway system.

Light Rail/Streetcar – Light Rail/Streetcar is also a fixed guideway transit system and operates in a variety of environments. These environments include: an exclusive right-of-way, a shared right-of-way (either in a median or parallel to the roadway), or in-street operation with other vehicles (i.e., streetcars). Vehicles lengths can range from short rail cars similar to a bus or multiple car trains. Because of their design, light rail systems typically operate at lower speeds and feature closely spaced stops. The Atlanta Streetcar is an example of a streetcar system.

9.4. Warrants for Accommodation

The Georgia Department of Transportation has established the following standard and guideline warrants to ensure that appropriate pedestrian and bicycle accommodations are included in transportation infrastructure projects. These warrants apply to roadways where pedestrians and bicyclists are permitted to travel. In a similar manner, warrants for transit accommodations are presented. Warrants must be evaluated as part of project concept development, and documented in the concept report.

If it is not practical to include the appropriate accommodation where a “Standard” warrant criterion is met, then agency approval and documentation will be required by formal Design Variance before the necessary accommodation can be excluded from the project. To obtain a Design Variance, a comprehensive study and formal request shall be submitted using the template provided in Appendix D of the GDOT Project Development Process (PDP). Refer also to Section 2.2 of this Manual.

Local Governments are encouraged to apply Complete Streets principals wherever it is practical to do so. Since the Local Maintenance and Improvement Grant Program (LMIG) is a state-funded grant program, GDOT oversight after the application process is normally limited. Therefore, it is not the intention of the Department to monitor application of Complete Streets policies to LMIG projects. Complete Streets policies do apply to all TE, TAP and LCI projects, and the application of these policies is monitored as part of GDOT’s normal oversight of these programs.

9.4.1. Pedestrian Warrants

Standard – Pedestrian accommodations *shall* be considered in all planning studies, and be included in all reconstruction, new construction, and capacity-adding projects which include curb and gutter as part of an urban border area (See Figure 6.3). Pedestrian accommodations *shall* also be considered along roadways with rural shoulders, which meet any of the following conditions:

1. along corridors with pedestrian travel generators and destinations (i.e. residential neighborhoods, commercial areas, schools, public parks, transit stops and stations, etc.), or areas where such generators and destinations can be expected prior to the design year of the project;
2. where there is evidence of pedestrian traffic (e.g., a worn path along roadside);
3. where pedestrian crashes equal or exceed a rate of ten for a ½-mile segment of roadway, over the most recent five years for which crash data is available; and

4. where a need is identified by a local government, MPO or regional commission through an adopted planning study.

Guideline – Pedestrian accommodations *should* be considered on projects that are located in areas with any of the following conditions:

1. within close proximity (i.e., a 1 mile radial distance) of a school, college, university, or major public institution (e.g., hospital, major park, etc.);
2. within an urbanized area; or area projected to be urbanized by an MPO, regional commission, or local government prior to the design year of the project;
3. where there is an occurrence of pedestrian crashes; and
4. any location where engineering judgment, planning analysis, or the public involvement process indicates a need.

The need for pedestrian accommodation for access to transit facilities should be evaluated as part of **Section 9.4.3 Transit Warrants**.

9.4.2. Bicycle Warrants

Standard – Bicycle accommodations *shall* be considered in all planning studies and *shall* be included in all reconstruction, new construction, and capacity-adding projects that are located in areas with any of the following conditions:

1. if the project is on a designated (i.e., adopted) U.S., State, regional, or local bicycle route;
2. where there is an existing bikeway along or linking to the end of the project alignment (e.g., shared lane, paved shoulder, bike lane, shared-use path, or cycle track);
3. along project alignments with bicycle travel generators and destinations (i.e. residential neighborhoods, commercial centers, schools, colleges, scenic byways, public parks, transit stops/stations, etc.); and
4. where there is an occurrence of reported bicycle crashes which equals or exceeds a rate of five for a 1-mile segment of roadway, over the most recent five years for which crash data is available.

Guideline – Bicycle accommodations *should* be considered on projects that are located in areas with any of the following conditions:

1. within close proximity (i.e., a 3 mile radial distance) of a school, college, university, or major public institution (e.g., hospital, major park, etc...);
2. where a project will provide connectivity between two or more existing bikeways or connects to an existing bikeway;
3. where there is an occurrence of bicycle crashes;
4. along a corridor where bicycle travel generators and destinations can be expected prior to the design year of the project;
5. any location where engineering judgment, planning analysis, or the public involvement process indicates a need.

Where a warrant is met, the appropriate type of accommodation should be determined using the AASHTO, [Guide for the Development of Bicycle Facilities](#).

On resurfacing projects, GDOT will consider requests from local governments to narrow or reduce the number of travel lanes in order to restripe the roadway to add bicycle lanes. Restriping that includes narrowing of the travel lanes will be considered where space is available and where the motor vehicle crash rate for sideswipe crashes (for the most recent five years for which data is available) does not exceed the statewide average for the same functional classification. A *marked* shared lane may be considered if sufficient width is not available for a bicycle lane and motor vehicle travel speeds are 35 mph or less.

On retained bridges where a bridge deck is being replaced or rehabilitated on a highway which bicycles are permitted to operate at each end, reference [Title 23 United States Code, Chapter 2, Section 217, Part \(e\)](#) for requirements.

The need for bicycle accommodations for access to transit facilities should be evaluated as part of **Section 9.4.3 Transit Warrants**.

9.4.3. Transit Warrants

Standard – Transit accommodations *shall* be considered in all planning studies and be included in all reconstruction, new construction, and capacity-adding projects that are located in areas with any of the following conditions:

1. *transit vehicles*: on corridors served by fixed-route transit; and
2. *pedestrian transit users*: within a $\frac{3}{4}$ - mile pedestrian catchment area of an existing fixed-route transit facility (i.e., stop, station, or park-and-ride lot). A catchment area is defined by a radial distance from a transit facility per Federal Transit Administration (FTA) guidelines - this includes crossing and intersecting streets.

Guideline – Transit accommodations *should* be considered on projects that are located in areas with any of the following conditions:

1. *bicyclist transit users*: within a 3-mile bicycle catchment area of an existing fixed-route transit facility;
2. *transit vehicles*: along a corridor programmed (and funded) to begin construction of high-capacity transit before the roadway project design year; and
3. *all transit users*: between transit stops/stations and local destinations.

Where a warrant is met, the need for accommodations should be validated through coordination with the transit service provider (and MPO, regional commission and/or local government, where applicable). This coordination is necessary for existing as well as planned transit facilities. It should be recognized that although classified as fixed-route transit, local and express bus routes are periodically changed in order to improve service to riders.

9.4.4. Exclusions

The consideration of bicycle and pedestrian warrants may be excluded from roadways for any of the following conditions:

1. routes- such as interstate highways and other high speed limited access facilities – on which bicycles are specifically not allowed;
2. for very low speed (i.e., < 35mph), low volume *residential* roadways where pedestrians and bicyclists can comfortably share the roadway with motor vehicles;
3. on side road tie-ins where there is no existing sidewalk or bicycle accommodation and widening of construction limits for sidewalk or bicycle accommodation would result in disproportionate impacts to adjacent property, as decided by the project development team on a case-by-case basis; and
4. sidewalks are not required in rural areas where curb and gutter is placed at the back of the useable shoulder *solely* for the purpose of reducing construction limits and/or meeting MS4 requirements.

Accommodation, based on meeting a Standard Warrant, may only be omitted after approval of a Design Variance as defined under **Section 9.4, Warrants for Accommodation**. Justification may be in the form of demonstrating that the cost of providing the required accommodations is “excessively disproportionate” to the need or probable use of that accommodation.

“Excessively disproportionate” may be defined as exceeding 20% of the total project cost. This cost should consider construction, required right-of-way, environmental impacts, and in some cases operation and maintenance. Where accommodations provide safety benefits to address bicycle and/or pedestrian crash history, these benefits must be considered.

9.5. Design of Accommodations

9.5.1. Pedestrian Accommodation Design

A variety of pedestrian groups utilize pedestrian facilities, as briefly described in **Section 9.2.1 Pedestrians** of this Manual. Their abilities vary significantly; in terms of agility, balance, cognition, coordination, endurance, flexibility, hearing, problem solving, strength, vision, and walking speed. Accordingly, pedestrian accommodations must be designed to be readily accessible and usable by all pedestrian groups.

The Americans with Disabilities Act (ADA) of 1990 and Section 504 of the Rehabilitation Act were passed to protect these rights. ADA requirements that specifically address public rights-of-way are contained in the [Proposed Accessibility Guidelines for Pedestrian Facilities in the Public Right-of-Way \(PROWAG\)](#) which is located on the [United States Access Board](#) web site. These guidelines cover access to public rights-of-way; including sidewalks, intersections, street crossings, and on-street parking.

These requirements apply to all: (1) newly constructed facilities, (2) altered portions of existing facilities, and (3) elements added to existing facilities which include pedestrian circulation and use within the public right-of-way. They also apply to temporary facilities, such as would be in place during staged construction. These requirements do not apply to existing pedestrian accommodations which are not within the scope of the project.

The Georgia DOT has summarized in the remainder of this section, criteria for designing accessible pedestrian accommodations in Georgia. These criteria comply with the PROWAG, but in some cases are more selective (e.g., a GDOT 5-ft minimum sidewalk width, compared to the PROWAG

minimum of 4-ft). If it is not practical to meet the more selective GDOT criteria, then the designer shall, at a minimum, comply with the criteria defined in the PROWAG. Refer to the PROWAG for these minimum criteria.

Where pedestrian accommodations are provided, they must be accessible by all potential users. Therefore, GDOT adopts the PROWAG requirements, as discussed below, as minimum standards for the design of pedestrian accommodations. If meeting these PROWAG requirements is either *structurally impractical*, *technically infeasible*, or will result in an unsafe condition, then a decision to select a value or retain an existing condition that does not meet the criteria defined in the PROWAG shall require a comprehensive study by an engineer and the prior approval of a Design Variance from the GDOT Chief Engineer.

Structurally Impractical – this applies to *new construction* only. “New construction”, for the purposes of these requirements, is defined as construction of a roadway where an existing roadway does not currently exist. “Structural impracticability” is limited only to those rare situations when the unique characteristics of terrain make it physically impossible to construct facilities that are fully compliant with the PROWAG.

If full compliance with PROWAG is structurally impracticable (based on an approved Design Variance), compliance is required to the extent that it is not structurally impracticable.

Technically Infeasible – this applies to *alterations* and *elements added* to existing facilities. An alteration is a change to an existing transportation facility that affects or could affect pedestrian access, circulation, or use. Alterations include reconstruction, rehabilitation, widening, resurfacing, or projects of similar scale and effect. “Technical infeasibility” is something that has little likelihood of being accomplished because existing structural conditions would require removing or altering a load-bearing member that is an essential part of the structural frame; or because other existing physical and site constraints prohibit modification or addition of elements, spaces, or features to fully comply with the requirements of the PROWAG.

If full compliance with PROWAG is technically infeasible (based on an approved Design Variance), compliance is required to the extent that it is not technically infeasible. Examples of existing physical or site constraints that may make compliance technically infeasible include, the following (Refer to PROWAG **Section R202 Alterations and Elements Added to Existing facilities**):

- Right-of-way acquisition in order to achieve full compliance is not mandatory (where no other right-of-way is being acquired), but should be considered. Improvements may be limited to the maximum extent practicable within the existing right-of-way.
- Underground structures that cannot be moved without significantly expanding the project scope.
- Adjacent developed facilities, including buildings that would have to be removed or relocated to achieve accessibility.
- Drainage cannot be maintained if the feature is made accessible.
- Notable natural or historic features that would have to be altered in a way that lessens their aesthetic or historic value.

- Underlying terrain that would require a significant expansion of the project scope to achieve accessibility.
- Street grades within the crosswalk exceed the pedestrian access route maximum cross slopes, provided an engineering analysis has concluded that it cannot be done without significantly expanding the project scope (for example, changing from resurfacing to reconstructing of the intersection).

Safety Considerations - when accessibility requirements would cause safety issues, compliance is required to the maximum extent practicable. A design variance is still required.

Reduction in Access – whatever decisions are made relating to structural impracticality or technical infeasibility, the addition or alteration of pedestrian accommodations shall not have the result of reducing the existing level of accessibility below the minimum PROWAG requirements.

Location of Sidewalk

Sidewalks are routinely provided along urban shoulders. Refer to **Section 6.7 Border Area (urban shoulder)** of this Manual for information on urban shoulders. Sidewalks, shared-use paths, and walkable shoulders are examples of pedestrian accommodations which can be provided along rural shoulders. **Figure 9.8a** and **Figure 9.8b** illustrates the location of these pedestrian accommodations on urban and rural shoulders, respectively.

Pedestrian Buffer Area

A pedestrian buffer area (often referred to as a “buffer strip” or “landscaping strip”) separates the sidewalk and the vehicle traveled way, as the physical area between the back of curb and the roadside edge of sidewalk. The buffer strip allows room to place utilities, bus stops, landscaping, street furniture, signs, and mail boxes without obstructing the pedestrian travel way, as well as providing comfort and safety benefits for walkers.

GDOT recommends a 6-ft wide buffer strip between the back of curb and the sidewalk. If a roadway has multiple driveways, a 6-ft buffer strip will provide the offset required to connect the sidewalk along the back of a standard concrete valley gutter driveway, without a shift in the sidewalk alignment. A buffer strip also provides some protection from overhanging objects from vehicles, and also creates a psychological barrier, enhancing pedestrian comfort. Grassing or pavers for the buffer strip are preferred, to provide a color contrast which helps visually impaired pedestrians to better distinguish between the sidewalk and roadway.

The buffer strip width should be no less than 2-ft. This reduced width may be appropriate where the separation between travel lanes and the sidewalk is increased by the inclusion of on-street parking or bicycle lanes.

Where right-of-way constraints will not permit a 2-ft buffer width, sidewalk may be constructed adjacent to the back of curb. This may occur, for example, in central business districts where buildings are located immediately adjacent to the back of sidewalk. In this case, a wider sidewalk may be necessary.

Width of Sidewalk

GDOT’s minimum sidewalk width is 5-ft. When right-of-way is limited at intersections, the designer should be careful not to violate this requirement by placing a sign post, signal mast arm, signal

cabinet, strain pole, pedestrian signal pedestal, or any other fixed object in a way that would reduce this width. Such “point narrowing” of the sidewalk width may be acceptable in isolated cases as long as there is at least 4-ft of clear unobstructed space. At medians and pedestrian refuge islands the clear width shall be no less than 5-ft.

The PROWAG **Section R302.4 Passing Spaces**, states that “*Where the clear width of pedestrian access routes is less than 1.5 m (5.0 ft), passing spaces must be provided at intervals of 61 m (200.0 feet) maximum. Passing spaces must be 1.5 m (5.0 ft) minimum by 1.5 m (5.0 ft) minimum. Passing spaces are permitted to overlap pedestrian access routes.*”

Higher pedestrian usage may warrant the use of wider sidewalks. Sidewalks wider than 5-ft may be appropriate to accommodate higher pedestrian flows refer to Toolkit 5 of the GDOT [Pedestrian and Streetscape Guide](#) or Section 3.2.3 of the AASHTO [Guide for the Planning, Design, and Operation of Pedestrian Facilities](#).

Sidewalk Grade

Steep grades and cross slopes should be avoided where possible. The longitudinal slope (or grade) of a sidewalk shall not exceed the general grade established for the adjacent street or roadway. In cases where sidewalk alignment deviates from the adjacent roadway, the longitudinal slope of the sidewalk shall not exceed 5%.

Sidewalk Cross-Slope

The maximum allowable sidewalk cross-slope is 2.0%.

Crosswalks

The grade at pedestrian street crossing shall not exceed 5%.

The cross slope for pedestrian street crossings with yield or stop control shall be no greater than 2%. Allowances for cross slope are made for street crossings without yield or stop control where vehicles can proceed through the intersection without stopping (5% max) and at midblock locations (may equal the street grade). Refer to **Section R302.6 Cross Slope** for more information relating to cross slope at pedestrian street crossings.

Refer to Section 12.2.3 of the GDOT [Signing and Marking Design Guidelines](#) and in GDOT Construction Detail T-11A for guidance relating to crosswalk location and design.

Sidewalk Surface

Sidewalk surfaces shall be firm, stable and slip-resistant, and comply with the following requirements:

- Vertical alignments must be generally planar and smooth. Changes in level are vertical rises between adjacent surfaces; including bumps, utility castings, expansion joints, etc. Changes in level shall not exceed ¼-in. without a bevel.
- Changes in level between ¼-in. and ½-in. shall be beveled to a slope no steeper than 1V:2H. The bevel shall be applied to the entire vertical surface of the discontinuity.
- Sidewalk areas with changes in level greater than ½-in. must be replaced or repaired.

- Horizontal openings of more than ½ in. cannot be retained. Elongated openings in grates shall be placed so that the long dimension is perpendicular to the dominant direction of travel.
- Flangeway gaps at pedestrian at-grade rail crossings shall be no more than 2.5-in. wide on non-freight rail track and 3-in. wide on freight rail track.

These requirements also apply to other elements of pedestrian circulation paths, including: pedestrian street crossings and at-grade railroad crossings, pedestrian underpasses and overpasses, and curb ramps and blended transitions.

Curb Ramps and Blended Transitions

Accessible curb ramps or blended transitions must be provided at all pedestrian street crossings. Curb ramps are ramps that are cut through or built up to the curb, and can be perpendicular or parallel, or a combination of the two. Blended transitions are raised pedestrian street crossings, depressed corners, or similar connections between the sidewalk and street level. These are illustrated and briefly described in the FHWA, [Accessible Sidewalks and Street Crossings – An Informational Guide](#). A helpful summary of the advantages and disadvantages of each is also provided. Additional information is provided in the GDOT [Pedestrian Streetscape Guide](#).

Perpendicular curb ramps are aligned perpendicular to the traffic they are crossing and guide pedestrians directly into the crosswalk. Turning space for wheel chairs is provided at the top of the ramp. This type of curb ramp is to be used wherever feasible. Parallel curb ramps have a running slope that is in-line with the direction of sidewalk travel and provide turning space at the bottom of the ramp. A parallel curb ramp may be used where there is little or no room between the sidewalk and curb for a perpendicular curb ramp.

A separate curb ramp is required at each pedestrian street crossing for new construction. For alterations, a single diagonal curb ramp is allowed where existing constraints prevent two curb ramps from being installed.

Curb ramp design shall comply with requirements in **Section R304 Curb Ramps and Blended Transitions** of the PROWAG. Refer to *GDOT Construction Standards and Details*, Construction Details A-2, A-3, and A-4 for construction details relating to curb ramps. See Chapter 11.1 of this Manual for guidance for when ADA curb ramps must be installed or repaired as part of pavement activities classified as “alterations”.

Detectable Warning Surfaces

Detectable warnings are a standardized surface feature built into or applied to walking surfaces to warn visually impaired people of potential hazards. Specifically, they indicate a boundary where a pedestrian accommodation and a roadway meet in a flush manner. They are placed at the bottom of curb ramps and at other locations such as depressed corners, borders of medians and islands, at the edge of transit platforms and where railroad tracks cross the sidewalk. Refer to GDOT Construction Detail A-4.

Refer to PROWAG **Sections R208 and R305 Detectable Warning Surfaces** for detailed guidance.

Mid-Block Crossings

Mid-block crossings should be considered where pedestrian mid-block crossing movements are heavy, such as may occur at transit stops or where there are clear origins/destinations located across from each other (e.g., between an apartment complex and grocery store, a school and a park, or a transit stop and a residential neighborhood); and where there is a long distance between crosswalks. Mid-block crossings should be evaluated on a case-by-case basis and an appropriate treatment selected based pedestrian needs, and both roadway and traffic conditions.

Some common mid-block crossing treatments include: marked crosswalks, Pedestrian Hybrid Beacons (PHB), Rectangular Rapid Flashing Beacons (RRFB), bulb outs, median refuge islands, and raised crosswalks. Enhancements may be required such as lighting, signage, and pavement marking.

Pedestrian refuge islands that are cut-through at street level should be no less than 6-ft in length, in the direction of pedestrian travel. Refer to **Section R305.2.4 Pedestrian Refuge Islands** of the [PROWAG](#).

For more guidance on when to use median islands, refer to the FHWA [Safety Effects of Marked Versus Unmarked Crosswalks at Uncontrolled Locations](#). Refer to Section 12.4 of the GDOT [Signing and Marking Design Guidelines](#) for design guidance on marked crosswalks at controlled and uncontrolled intersections. For additional information on mid-block crossings and treatments refer to the AASHTO [Guide for the Planning, Design, and Operation of Pedestrian Facilities](#), the GDOT [Pedestrian and Streetscape Guide](#), the AASHTO [Guide for Geometric Design of Transit Facilities on Highways and Streets](#), and the FHWA [Manual on Uniform Traffic Control Devices \(MUTCD\)](#).

At-Grade railroad Crossings

Refer to the PROWAG for requirements relating to at-grade railroad crossings.

Roundabouts

The PROWAG **Section R306.3.2 Pedestrian Activated Signals** states that, “*At roundabouts with multi-lane pedestrian street crossings, a pedestrian activated signal complying with R209 shall be provided for each multi-lane segment of each pedestrian street crossing, including the splitter island.*” It is GDOT current practice to install necessary conduit across all roundabout multilane pedestrian crossings, from shoulder to splitter island, in the location required for installation of a future pedestrian signal. The pedestrian signal could then be installed later if the above requirement is unchanged when the PROWAG is finally adopted by the US Department of Justice.

Pedestrian Signals

Refer to the MUTCD for guidance relating to accessible pedestrian signals and pedestrian push buttons. These should be provided when new pedestrian signals are installed. Also, refer to the GDOT [Traffic Signal Design Guidelines](#) manual.

Transit Stops and Shelters

Refer to the PROWAG **Section R308 Transit Stops and Transit Shelters** and the AASHTO *Guide for Geometric Design of Transit Facilities on Highways and Streets*. New or altered bus loading pads shall meet the following criteria:

- Provide a firm, stable, and slip resistant surface.

- Provide a minimum clear length of 8 feet (measured from the curb or roadway edge) and minimum clear width of 5 feet (measured parallel to the roadway).
- Connect the pad to streets, sidewalks, or pedestrian circulation paths with at least one accessible route.
- The slope of the pad parallel to the roadway will be the same as the roadway to the extent practicable.
- Provide a desirable cross slope of 1.5% up to a maximum cross slope of 2.0% perpendicular to the roadway.

On-Street Parking

Refer to the PROWAG **Section R214 and R309 On-Street Parking Spaces**.

Bridges

A typical sidewalk width across a bridge in an urban area is 5'-6" and does not include a buffer strip between the back of curb and sidewalk. Therefore, the width of the sidewalk should transition from the roadway cross section to the bridge cross section before the approach slab. This will include eliminating the buffer strip in advance of the bridge.

Tapering down a sidewalk and buffer strip to match the bridge shoulder is typically accomplished in a space between 50-ft to 100-ft in advance of the bridge. Where guardrail is used on the bridge approaches, the sidewalk transition should follow the guardrail offset transition.

Work Zones

Pedestrian access routes must be provided when a pedestrian circulation path is temporarily closed by construction, alterations, maintenance operations or other conditions. The alternate pedestrian route must comply with MUTCD standards. Refer to pedestrian accessibility requirements in **GDOT Special Provision, Section 150.1.04-C. Pedestrian Considerations**. The current **GDOT SP 150 – Traffic Control** is located on GDOT's website at the following address:

http://www.dot.ga.gov/PartnerSmart/Business/Source/special_provisions/shelf/sp150.pdf

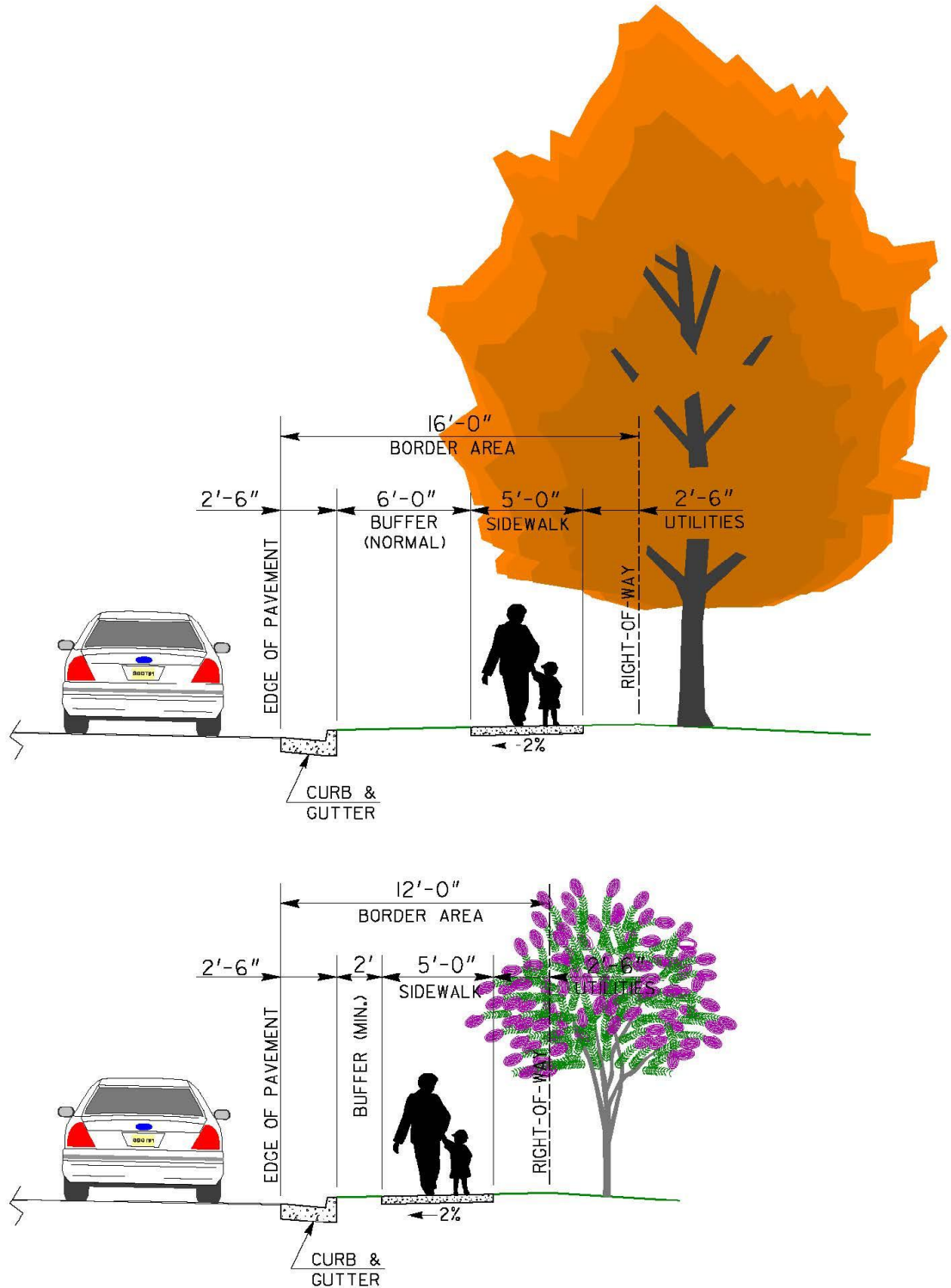

Figure 9.8a Illustrations of Pedestrian Accommodations on an Urban Shoulder

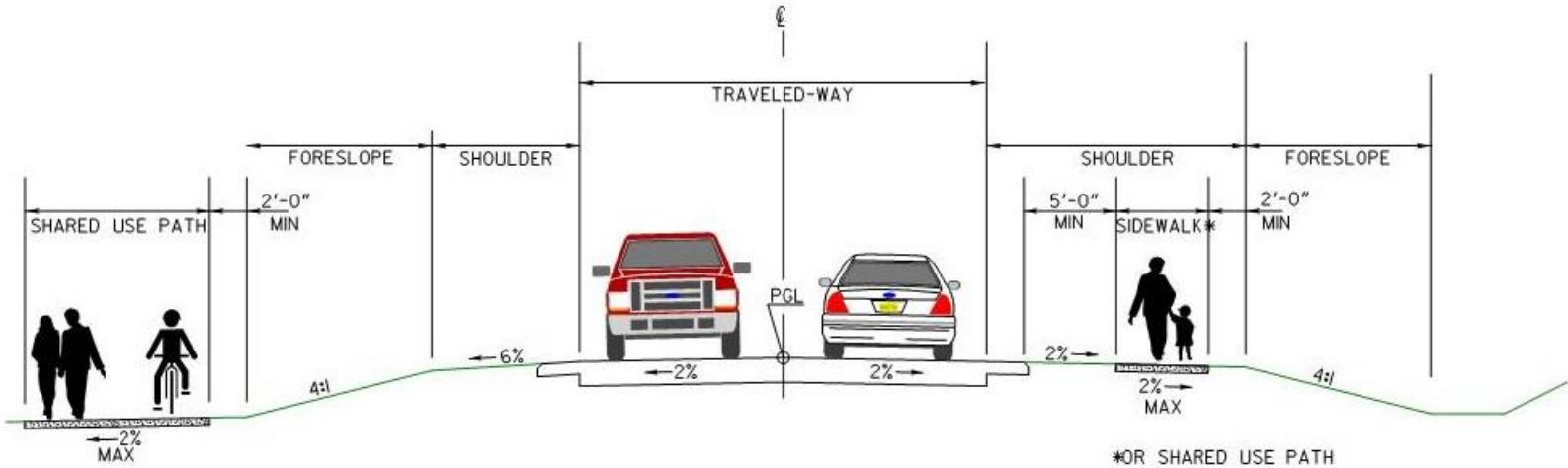

Figure 9.8b Illustrations of Pedestrian Accommodations on a Rural Shoulder

9.5.2. Bicycle Accommodation Design

GDOT adopts the guidance published in the 2012 AASHTO [Guide for the Development of Bicycle Facilities](#) (AASHTO Guide) for the selection and design of bicycle accommodations. Use of the 2015 FHWA [Separated Bikeway Planning and Design Guide](#) (FHWA Guide) and the NACTO [Urban Design Guide](#) (NACTO Guide) is encouraged in urban areas. Design should also consider local and regional bicycle design guidelines, where these guidelines are consistent with one of the three “Guides” mentioned above. Refer to the MUTCD and the GDOT [Signing and Marking Design Guidelines](#) for signing and marking requirements related to bicycle facilities.

Selection of Bikeway Type

Bikeway type should be selected based on context sensitive⁴ design principles, which includes consideration of the needs of typical users, characteristics of the roadway corridor, accessibility of the facility to area destinations, and other considerations. Coordination with the local government having jurisdiction and/or the local planning agency will be helpful in understanding this context. The most appropriate bikeway type should be selected only after careful examination of bicyclist needs and local conditions along the street or corridor involved.

Bikeways may be classified as either on-road or off-road facilities. Common on-road facilities include bicycle lanes, buffered bike lanes, and shared lanes. Common off-road facilities include shared-use paths located either on independent right-of-way or adjacent to the roadway (i.e., a sidepath). Separated bike lanes may be either on-road or off-road bikeways, and are sometimes referred to as “cycle tracks” or “protected bike lanes.” Refer to the AASHTO Guide for more information about on-road and off-road bikeways, and the FHWA Guide for more information about separated bike lanes.

On-road bikeways allow bicyclists to circulate with traffic, allow easier access to destinations, and help bicyclists behave more predictably. Off-road bikeways may allow greater separation from high-speed traffic but need careful consideration at driveways, intersections, and constrained areas.

For urban areas, on-street bicycle lanes, on-street buffered bike lanes, and separated bike lanes are preferred over shared lanes because they provide a separate or more visible facility, which increases user safety and comfort. If an existing bicycle facility is present in the form of a shared lane, consideration should be given to upgrading the facility to one of these three. Where children are an important user group for a bicycle facility (e.g., in the vicinity of a school, park, family attraction, etc...), a separated facility should be considered, such as a separated bike lane or shared-use path. Wide sidewalks are not considered a form of bicycle accommodation.

Bikeable Shoulders (rural areas)

A bikeable shoulder is appropriate for rural areas and consists of smooth pavement on a 6.5-ft wide paved shoulder. Bikeable shoulders are separated from vehicular traffic by a 16-in rumble strip,

⁴ Context sensitive design may be defined as a collaborative, interdisciplinary process which involves all stakeholders to design a transportation facility that fits its applicable setting and preserves scenic, aesthetic, historic and environmental resources while maintaining safety and mobility. This process balances design objectives for safety, efficiency, capacity and maintenance while integrating community objectives relating to compatibility, livability, sense of place, urban design, cost and environmental impacts.

offset from the edge of traveled way. These rumble strips are designed with a skip pattern to allow bicyclists to safely enter and exit the shoulder. Refer to [Georgia Construction Detail](#) for additional information. A bikeable shoulder is illustrated in **Figure 9.10 Illustration of a Bikeable Shoulder**.

Shared Lanes

A shared lane requires that motorized vehicles and bicycles share the outside travel lane of the roadway. A shared roadway may include pavement markings in the form of a marked shared lane which provides wayfinding guidance to bicyclists and alerts drivers that bicyclists are likely to be operating in the roadway travel lanes. Shared lanes may be used where space constraints or other limitations do not allow for the width required for a bicycle lane or as otherwise appropriate per the AASHTO Guide (specifically refer to Table 2-3).

Where posted speeds do not exceed 35 mph and it is desirable to provide a higher level of guidance to bicyclists and motorists a marked shared lanes can be considered (refer to the 2009 MUTCD Section 9C.07 and Section 4.4 of the AASHTO Guide). Marked shared lanes scan be used to fill gaps on a corridor where bicycle lanes are the prevailing facility, but space constraints or other limitations do not permit a continuous bikeway. Proper striping transitions should be provided between the two types of bikeways.

On-Street Bicycle Lanes

An on-street bicycle lane consists of a bike lane designated by striping, signing and pavement markings, and commonly provides for one-way travel, in the same direction as the adjacent travel lane. GDOT has defined 4-ft as the minimum width for on-street bicycle lanes in areas with 2.5-ft curb and gutter, as illustrated in **Figure 9.10 Illustration of a Bikeable Shoulder and a Bicycle Lane**. The 4-ft bicycle lane is developed between the traveled way and gutter, and so does not include the gutter width. The minimum bike lane width is 5-ft for areas where the bike lane is immediately adjacent to a curb, guardrail or other vertical surface. If the space to the right of the traveled way striping is less than 4-ft wide, the route cannot be signed or marked as a “bicycle lane”.

A width greater than 4-ft may be appropriate in some cases - refer to Section 4.6.4 and 4.6.5 of the AASHTO Guide. Where on-street parking is permitted, the minimum bike lane width is 5-ft. Two feet of additional width should be provided for bicycle lanes located adjacent to on-street parking, where practical. Bicycle safe grates are required on drop inlets for roadways where bicycles are permitted.

On-Street Buffered Bike Lanes

On-street buffered bike lanes are similar to on-street bike lanes, except that a pavement marking buffer is used to increase lateral separation between bicyclist and motor vehicles. On-street buffered bike lanes should be considered for roadways with posted or operating speeds of 35 mph or greater. The painted buffer should be at least 2-ft wide. Refer to the NACTO Guide for additional information.

Separated Bike Lanes

Separated Bike lanes are defined in the FHWA Guide, as follows:

A separated bike lane is an exclusive facility for bicyclists that is located within or directly adjacent to the roadway and that is physically separated from motor vehicle traffic with a vertical

element. Separated bike lanes are differentiated from standard and buffered bike lanes by the vertical element. They are differentiated from shared use paths (and sidepaths) by their more proximate relationship to the adjacent roadway and the fact that they are bike-only facilities. Separated bike lanes are also sometimes called “cycle tracks” or “protected bike lanes.”

Within the common elements of separated bike lanes – dedicated space for cyclists that is separated from motor vehicle travel and parking lanes – practitioners have flexibility in choosing specific design elements. Separated bike lanes can operate as one-way or two-way facilities; their designs can integrate with turning automobile traffic at intersections or can be more fully separated; they can be designed at roadway grade, at sidewalk grade or at an intermediate grade; and they can be separated from the adjacent roadway or sidewalk with a variety of treatments including but not limited to on-street parking, raised curbs or medians, bollards, landscaping, or planters.

Refer to the FHWA Guide for design guidance relating to separated bike lanes.

Shared-Use Paths (Bicyclist & Pedestrian)

A shared-use path is a combined bikeway and pedestrian facility located within an independent right-of-way, or located within the roadway right-of-way, and physically separated from motor vehicle traffic by an open space or barrier (i.e., a sidepath). Because a shared-use path is not an exclusive bicycle facility, it should not normally be considered as an “equal” alternative to an on-road bikeway paths. It may be used to supplement a network of on-road bicycle facilities.

Most shared-use paths are designated for two-way travel and are designed for both transportation and recreation purposes. Shared-use path design is similar to roadway design, but on a smaller scale and with typically lower design speeds (refer to Chapter 5 of the AASHTO Guide). Shared-use paths are also be used by pedestrians, skaters, equestrians, and other non-motorized users and should be designed accordingly. These facilities must meet all applicable ADA requirements (refer to Section 5.1.1 of the AASHTO Guide).

Sidepaths are a specific type of shared-use path that run adjacent to the roadway and should only be used after considering potential conflicts associated with sidepaths (refer to Section 5.2.2 of the AASHTO Guide). Sidepaths may be considered where one or more of the following conditions exist (Page 5-10 of the AASHTO Guide):

- The adjacent roadway has relatively high-volume and high-speed motor vehicle traffic that might discourage bicyclists from riding on the roadway, potentially increasing sidewalk riding, and there are no practical alternatives for either improving the roadway or accommodating bicyclists on nearby parallel streets.
- The sidepath is used for a short distance to provide continuity between sections of path in independent rights-of-way, or to connect local streets that are used as bicycle routes.
- The sidepath can be built where there are few roadway and driveway crossings. (A pair of sidepaths – one on each side of the roadway - may be considered for roadways with frequent cross-streets and driveways. Each sidepath would be signed for one-way bicycle traffic.)
- The sidepath can be terminated (at each end) onto streets that accommodate bicyclists, onto another path, or in a location that is otherwise bicycle compatible.

Shared-use path users should never be given conflicting traffic control messages; therefore, appropriate signing and paving marking is required and should follow the standards and guidance for shared-use paths in the Chapter 9 of the MUTCD and Section 5.4 of the AASHTO Guide. Signs and pavement markings should be retroreflective and all signs should conform to the color, legend, and shape requirements described in the MUTCD. Regulatory, warning, and guide signs are used on shared use paths. The designer should use the ones that apply to the specific project's needs. Pavement markings should not be slippery or rise more than 0.16 inches above the pavement. Most common pavement markings on shared-use paths are used for crosswalks, centerlines stripping, edgeline stripping, stop or yield lines, lines for supplementing intersection control, and lines warning approaching obstructions or approaching crossings. They can provide an important guidance and information for path and roadway users.

Occasionally a shared-use-path or sidepath may be planned on a roadway bridge structure. The following table and figures represent the minimum dimensions for shared-use-path options across bridges with respect to the design speed, functional classification of the roadway, and the physical constraints between the bridge barriers/parapets. The dimensions below reflect the guidelines published in the AASHTO "Guide for the Development of Bicycle Facilities" (2012 edition). Wider dimensions should be considered if necessary to meet anticipated volumes and mix users.

RECOMMENDED OPTIONS FOR SHARED USE PATH ON BRIDGE			
DESIGN SPEED	LOCAL	COLLECTOR	ARTERIAL
< 45 MPH	FIGURE A, B, C, D, E	FIGURE A, B, C, D, E	FIGURE B, C, D, E
= 45 MPH	FIGURE B, C, D, E	FIGURE B, C, D, E	FIGURE B, C, D, E
> OR = 50 MPH	FIGURE D, E	FIGURE D, E	FIGURE D, E

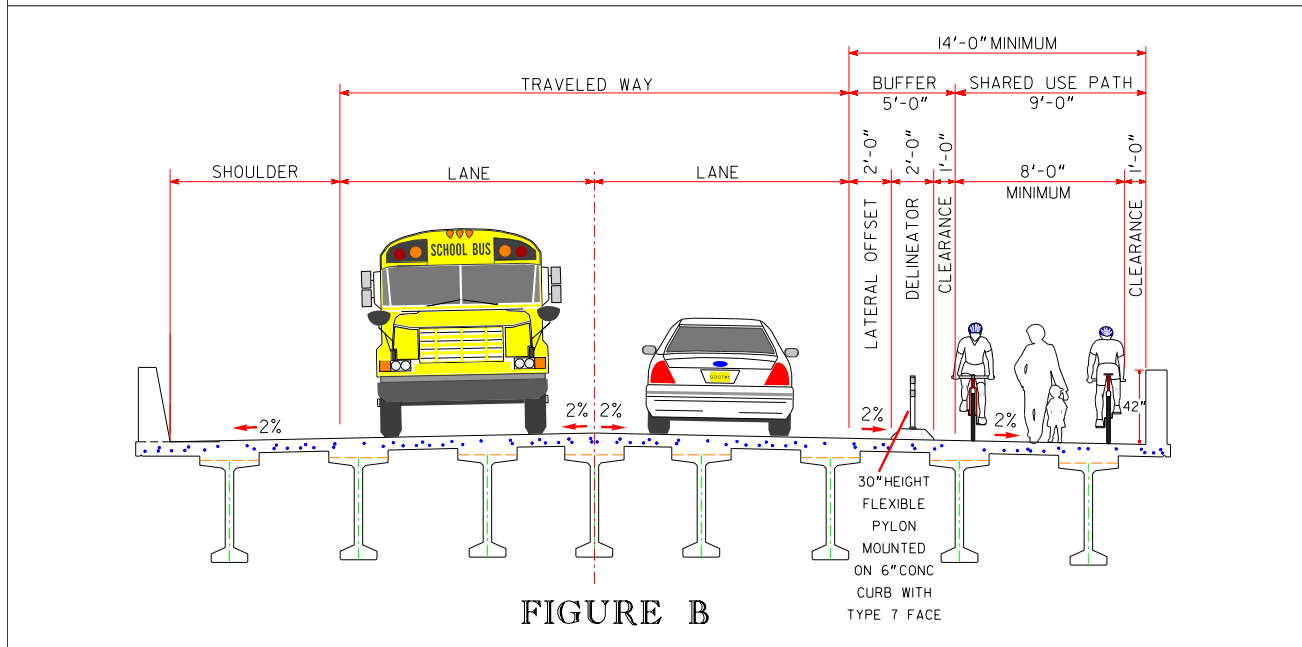
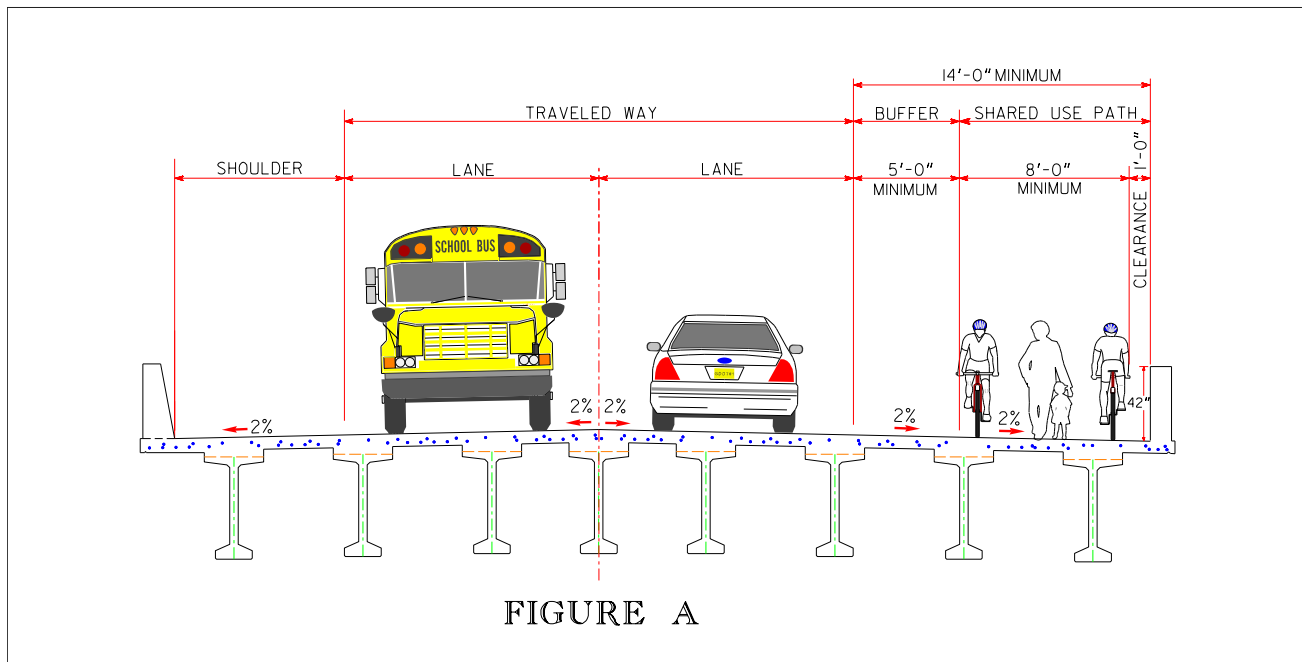

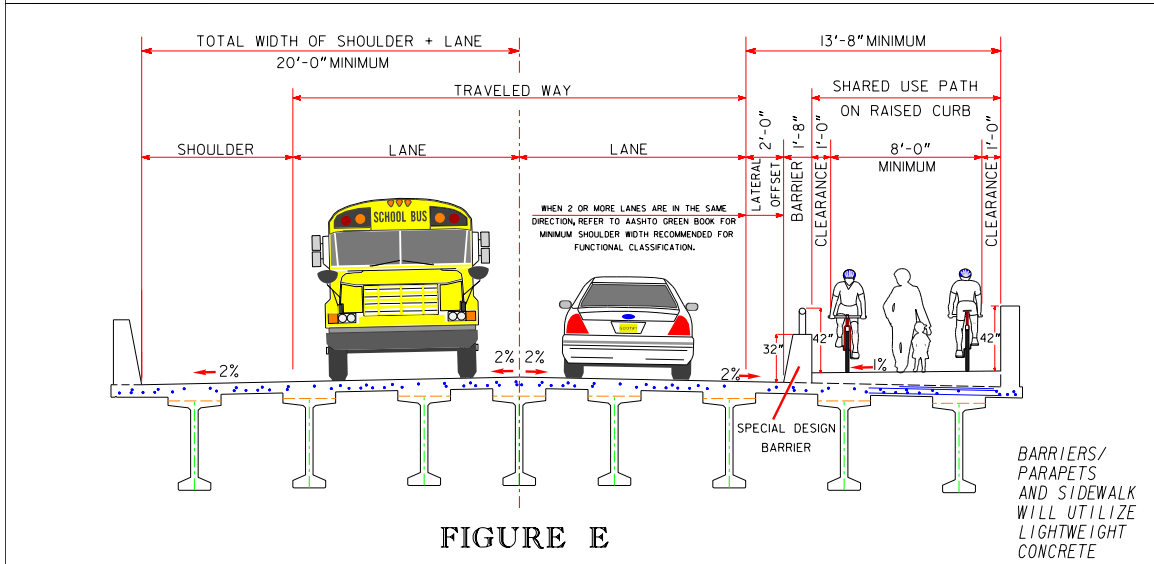
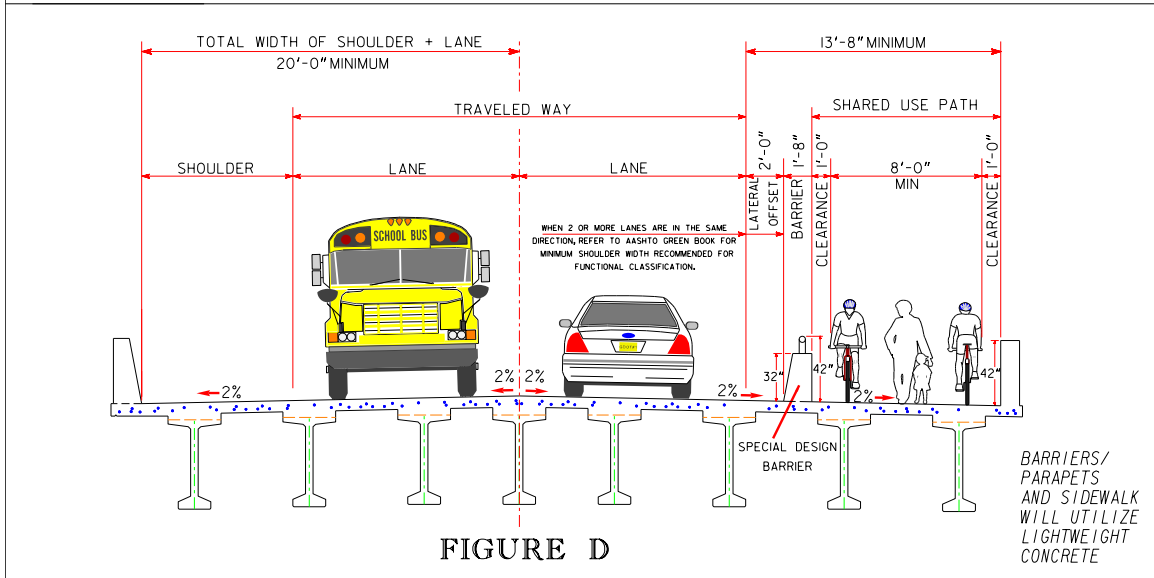
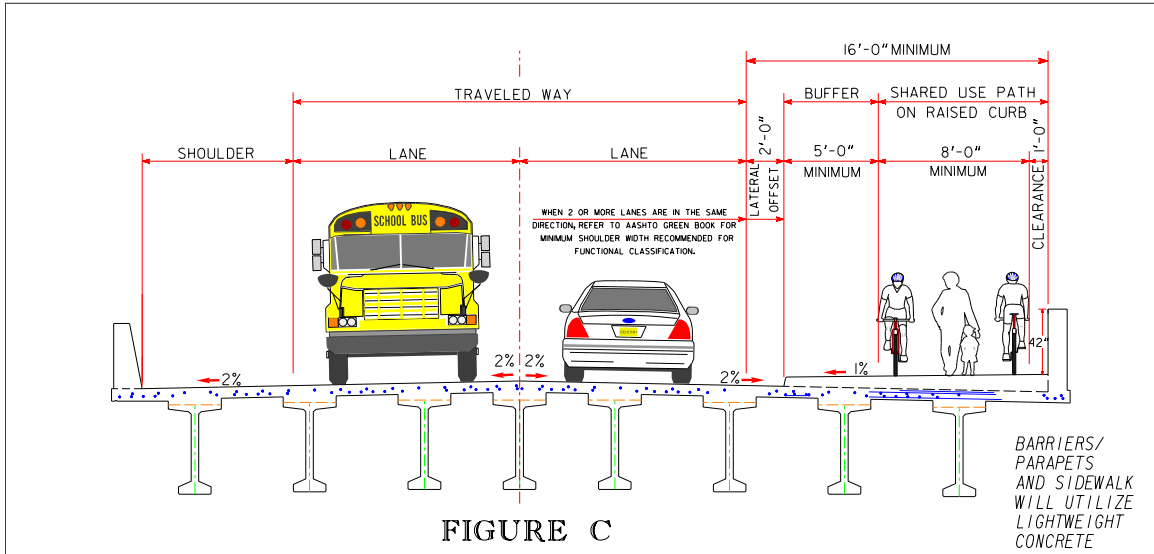
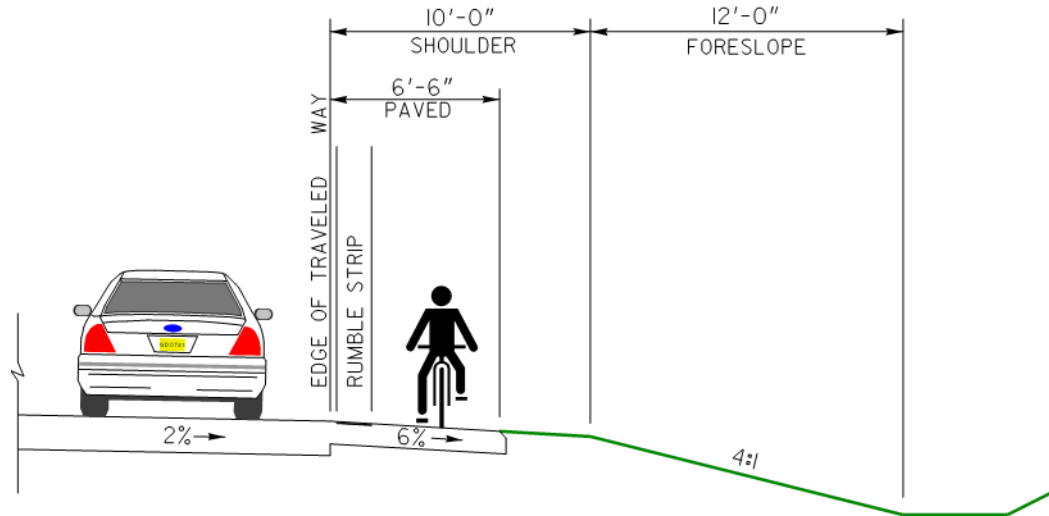

Figure 9.9. Illustrations of Shared-Use Path on Bridge Structures – Minimum Dimensions

Intersections and Connections Between Different Bikeway Types

The design of bikeways should give particular attention to providing connections between on-road and off-road bikeways and reducing bicyclist/motorized vehicle conflicts at cross-streets, driveways and other intersections (refer to Sections 4.8 and 5.3 of the AASHTO Guide).



BIKEABLE SHOULDER ON RURAL ROADWAY

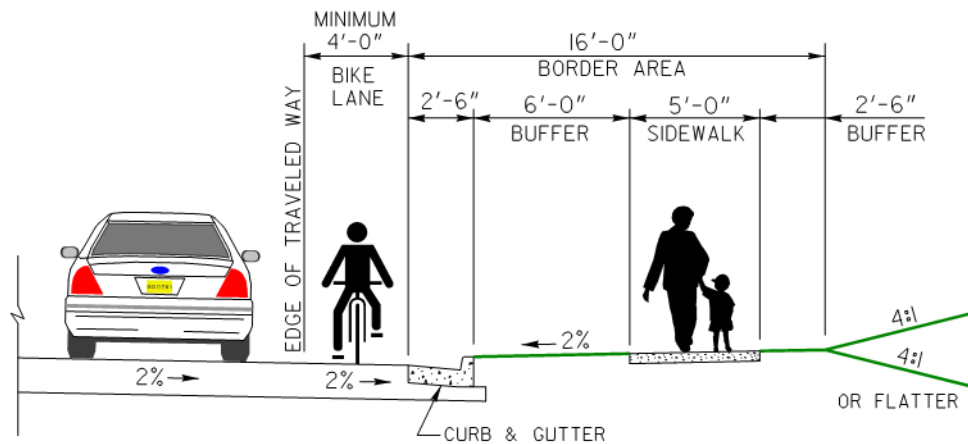

BIKE LANE ON URBAN ROADWAY

Figure 9.10 Illustrations of a Bikeable Shoulder and a Bicycle Lane.

9.5.3. Transit Accommodation Design

One of the most important considerations for ensuring safe and convenient access to transit stops and facilities is to provide accommodations that allow users to cross the road to access these facilities. This is of particular concern as a disproportionately high number of pedestrian crashes occur at transit stops. Accordingly, each transit stop should be evaluated to ensure that adequate crossing opportunities are provided. This may include relocation of the bus stop where safe access cannot be otherwise provided.

Along with accessibility, other accommodations may need to be considered. Examples include bus pullouts, lane width, intersection turning radii, lane and signal prioritization, and signage, and space for transit stop amenities. Transit stop locations should be placed to not affect the sight distance of nearby crossroads.

Transit user accommodations commonly include pedestrian/bicycle accommodations that provide safe and convenient access to a transit facility. For the design of accommodations which address user access to a transit facility refer to **Sections 9.5.1 Pedestrian Facility Design** and **9.5.2 Bicycle Facility Design** of this Manual.

For transit user accommodations at a transit facility (e.g., most commonly a concrete bus loading pad for a transit stop) and for transit vehicle accommodations refer to the following publications:

- [Guide for Geometric Design of Transit Facilities on Highways and Streets](#), AASHTO, 2014;
- [Guide for High-Occupancy Vehicle \(HOV\) Facilities](#), AASHTO, 2004;
- [Guide for the Design of Park-and-Ride Facilities](#), AASHTO, 2004; and
- [Guidelines for the Location and Design of Bus Stops \(TCRP Report 19\)](#), TCRP, 1996.
- [Pedestrian Safety Guide for Transit Agencies](#), FHWA, 2008.

In most cases, high capacity transit vehicle accommodations (e.g., traffic signal preemption, queue-jumper lanes) would be included as part of a transit-focused project. Preservation of right-of-way may be considered as part of a roadway project.

The location, selection, and design of accommodations at a transit facility and for transit vehicles should be coordinated with the affected transit service provider and local government, where applicable.

9.6. Acknowledgements

The GDOT Complete Streets Design Policy was developed by the GDOT Division of Engineering in coordination with the Divisions of Operations and Permits, Planning, and Intermodal. The Division of Engineering acknowledges and appreciates the efforts of Byron Rushing for his part in helping develop the original GDOT Bicycle and Pedestrian policy and for his assistance with expanding that policy to its present form, as a Complete Streets policy.

The GDOT Division of Engineering also acknowledges and appreciates the efforts of the below individuals who provided valuable comments on draft versions of this policy.

- Byron Rushing, Amy Goodwin [ARC](#)
- Rebecca Serna [Atlanta Bicycle Coalition](#)

- Brent Buice [Georgia Bikes!](#)
- Joshua Mello, Alexandra Frackelton [City of Atlanta](#)
- Amanda Thompson [City of Decatur](#)
- Robert Dell-Ross, Andrew Antweiler [City of Roswell](#)
- Laraine Vance [Cobb Community Transit](#)
- - [Georgia Municipal Association](#)
- Brian Borden [Georgia Regional Transportation Authority \(GRTA\)](#)
- Vince Edwards [Gwinnett County Transit](#)
- Donald Williams, John Crocker, Tameka Wimberly [Metropolitan Atlanta Rapid Transit Authority \(MARTA\)](#)
- Barbara McCann, Stefanie Seskin [Smart Growth America - National Complete Streets Coalition](#)
- Sally Flocks [PEDS](#)
- Keith Melton [USDOT Federal Transit Administration \(FTA\)](#)
- Andrew Edwards [USDOT FHWA Georgia Division](#)

Chapter 10. Pavement Design - Contents

Chapter 10. Pavement Design - Contents	10-i
10.1 Overview.....	10-1
10.2 Design Resources	10-1
10.3 Design Considerations	10-1
10.3.1 Design Period.....	10-1
10.3.2 Traffic Volume Projections	10-2
10.3.3 Pavement Structure and Type Changes	10-2
10.3.4 Pavement Subgrade.....	10-6
10.3.5 Pavement Widening	10-6
10.3.6 Pavement Base	10-7
10.3.7 Pavement Approval/Re-approval	10-8
10.3.8 Cross Road Design	10-8
10.4 Alternate Pavement Bid Process.....	10-9
10.4.1 Introduction.....	10-9
10.4.2 Design & Construction Plan Requirements	10-9
10.4.3 Mainline Travel Lane Alternates.....	10-10
10.4.4 Paved Shoulder Alternates.....	10-10
10.4.5 Base Alternates	10-10
10.4.6 Quantities & AASHTO Transport Construction Estimate System (CES).....	10-10
10.5 Rigid Pavement	10-10
10.5.1 Introduction.....	10-10
10.5.2 Design Considerations	10-11
10.5.3 Constructability.....	10-11
10.6 Flexible Pavement	10-13
10.6.1 Introduction.....	10-13
10.6.2 Design Considerations	10-14
10.6.3 Constructability.....	10-15
10.7 Composite Section	10-16
10.8 Shoulders	10-16
10.8.1 Introduction.....	10-16
10.8.2 Design Considerations	10-16
10.8.3 Curb and Gutter.....	10-16

10.9 Roundabouts10-16

10.10 Driveways and Parking Areas10-17

 10.10.1 Design Considerations10-17

 10.10.2 Standard Pavement Structure10-17

Chapter 10. Pavement Design

10.1 Overview

The purpose of this chapter is to provide guidance for the pavement design process and areas of design and construction plan production related to pavement design. This chapter does not define pavement design standard criteria. For pavement design guidelines and policy, use the [Pavement Design Manual](#). Final pavement design(s) require approval from the State Pavement Engineer (SPE) if the Guidelines for Minor Pavement Projects is not applicable. This chapter is for use on projects other than 3R or Preventative Maintenance Projects. Guidance for 3R and Preventative Maintenance can be found in **Chapter 11**.

10.2 Design Resources

The GDOT [Pavement Design Manual](#) (PDM) is owned and maintained by the Office of Materials and Testing (OMAT). The manual was written to provide a formal, uniform, and comprehensive process, and serve as a source of information that fosters practical engineering in the design of pavements. The PDM reflects the material, climate, and traffic conditions present in Georgia versus that of national standard. The PDM provides designers insight on pavement design, pavement layers, and pavement condition evaluation guidelines.

Roadway designers will use the [GDOT Pavement Design Tool v2.0](#) to design flexible and rigid pavement structures. Other design resources include the [Guidelines for Minor Pavement Projects](#), [Guidelines for Minor Pavement Projects Tool](#), [Temporary Pavements for Minor Pavement Projects](#), [Criteria for Use of Asphaltic Concrete Layer and Mix Types](#), [GDOT Construction Standards](#), [GDOT Publications Policies & Procedures](#), [Standard Specifications Construction of Transportation Systems](#), AASHTO Guide for the Design of Pavement Structures and the [Guidelines for Capital Maintenance Projects](#), and [Pavement Type Selection Manual](#). The [Plan Development Process Manual \(PDP\)](#), [Pavement Design Approval Process flowchart](#), and [Pavement Design Submission and Approval Process](#) should be referenced for specific information related to the requirements in obtaining an approved pavement design and the timing of submittals.

10.3 Design Considerations

10.3.1 Design Period

Permanent Pavement

Permanent Pavement design period will reflect the design life of the project programmed. Typical design life is 20 years. There are projects that have a shorter design life. (e.g. Quick projects typically have a design life of 10 years.)

Temporary Pavement

The temporary pavement design period will be based on the length of time the pavement will be used during staged construction rounded up to a whole number of years. More information on temporary pavement can be found in section 10.6.3 and in the Pavement Design Manual, section 11.7.

10.3.2 Traffic Volume Projections

Reference the [Design Traffic Forecasting Manual](#) for traffic data and traffic volume projections. See the [Design Policy Manual Chapter 13](#) for Trip Generation, Trip Assignment, Capacity and Design. Typically, for projects that include pavement construction, traffic diagrams or traffic assignment correspondence will be provided. In addition to the project's base and design years projections are also provided for the base year plus 2 years and the design year plus 2 years. Designs for the +2 traffic should be included in the Pavement Design Package.

The base year and design year is defined as follows:

- Base Year = Let Date + Construction Time
- Design Year = Base Year + Design Life

Traffic Diagrams

Traffic Diagrams show the graphic representations of existing traffic conditions or future traffic conditions. The traffic diagrams show turning movements of a roadway.

Traffic Assignment

Traffic Assignments are typically one page and show two way average daily traffic (ADT), design hourly volume (DHV), K-factor, directional distribution (D), and truck percentages. The one way ADT should be half of the ADT. This is typically used for bridge projects, turn lane projects, and other minor projects which do not require a traffic diagram.

10.3.3 Pavement Structure and Type Changes

Rigid to Flexible Pavement Transition Scenarios:

- *New Construction for both pavements:*
A detail is used when the joint between Jointed Plain Concrete Pavement (JPCP) to Hot Mix Asphalt (HMA) is transverse to the direction of travel. This detail is available from the GDOT Office of Design Policy & Support. The detail will need to be modified by the Designer to reflect their project's typical section pavement layers and should be included in the typical sections prior to submitting proposed pavement designs to the Pavement Design Committee.

For Continuously Reinforced Concrete Pavement (CRCP) no specific transition detail is required to transition to any other pavement type. However two special details need to be obtained from the GDOT Office of Design Policy & Support: ending CRCP transversely through the use of lug anchors and a reinforcement detail.

No transition detail or joint sealant is needed along longitudinal joints between new concrete and new asphalt pavement.

- *New Construction for one pavement:*
For longitudinal joints between concrete and asphalt pavements a Specification Section 407 Asphalt-Rubber Joint and Crack Seal, TP S is typically specified and included as a separate pay item.

Changing Pavement Structure Material Layer Thicknesses Along an Alignment

There may be opportunities to reduce construction material costs by changing the pavement structure along the alignment when changes occur that allow a reduction in the material layer

thicknesses needed for a pavement structure design to meet GDOT guidelines or standard practice. This includes changes to:

- ADT,
- 24-hour truck Single Unit (SU) or Combination Unit (COMB) percentage, or
- lane distribution (i.e. ESAL loading factors)

Reducing the layer thicknesses provides a reduction in pavement material costs and possibly lifts of construction; however, changing the pavement structure can reduce ease of construction which can increase costs. Therefore, it may not be prudent to change the layer thickness at the exact location where these changes occur. Proposed changes should occur at natural construction breaks such as project exceptions or bridges. Staged construction can also provide locations such as intersections where subgrade, base, or pavement construction is not continuous.

Changing Pavement Structure Material Layer Thicknesses at Crossroad Intersections

Often crossroads intersecting the mainline have significantly different ADT, 24-hour truck Single Unit (SU) or Combination Unit (COMB) percentage, or lane distribution (i.e. ESAL loading factors). This may require different material layer thicknesses for a pavement structure design to meet GDOT guidelines or standard practice. For example:

Crossroad requires increased layer thicknesses:

The crossroad pavement structure should be used on the crossroad and through the mainline intersection. In this situation the mainline effectively becomes the intersecting crossroad and the second situation (described below) applies to the mainline at this location.

Crossroad requires reduced layer thicknesses:

It may become beneficial to reduce the pavement structure on the crossroad. The change from the crossroad pavement to mainline pavement structure should occur at the mainline outside travel lane edge of pavement (through or turn lane) or outside edge of paved shoulder (projected across the intersection) if the mainline paved shoulder pavement structure and slope is the same as the travel lanes. All crossroads constructed with a pavement structure different from the mainline require an approved pavement design.

Changing Pavement Type at Crossroad Intersections

Crossroads may have a different pavement material type than the mainline where they intersect with the difference usually being a concrete mainline with some or all HMA crossroads or a HMA mainline with some or all concrete crossroads.

Intersection with concrete mainline and HMA crossroad:

The HMA crossroad pavement should begin at the concrete mainline outside travel lane edge of pavement (through or turn lane) or outside edge of paved shoulder (projected across the intersection) if the mainline paved shoulder pavement structure and slope is the same as the travel lanes. The crossroad pavement structure butts against the side of the concrete mainline pavement structure and no transition or joint detail is needed.

Intersection with HMA mainline and concrete crossroad:

The concrete crossroad pavement should begin at the HMA mainline outside travel lane edge of pavement (through or turn lane) or outside edge of paved shoulder (projected across the intersection) if the mainline paved shoulder pavement structure and slope is the same as the travel lanes. The crossroad pavement structure butts against the side of the HMA mainline pavement

structure. For a JPCP crossroad pavement structure no transition or joint detail is needed. For a Continuously Reinforced Concrete Pavement (CRCP) cross pavement structure the CRCP pavement structure is terminated using reinforced concrete lug anchors as specified in the required CRCP special construction details which can be obtained from the GDOT Office of Design Policy & Support.

Changing Pavement Type or Pavement Structure Material Layer Thicknesses at Interchange Ramp Intersections

Often the Interstate, crossroad, and the connecting ramps can be of different pavement types with JPCP and HMA being common for all three and CRCP not being used for the ramps. For Interstate interchanges GDOT's typical practice has been to construct the ramps and crossroad section within the functional area of the interchange with JPCP. As used here the functional area of the interchange on the crossroad approaches extends to the beginning of the tapers for the left and right turn lanes to the ramps. See Figure 10.1, Illustration of Typical Concrete Ramp on Interchange. GDOT has often extended this practice to non-Interstate interchanges.

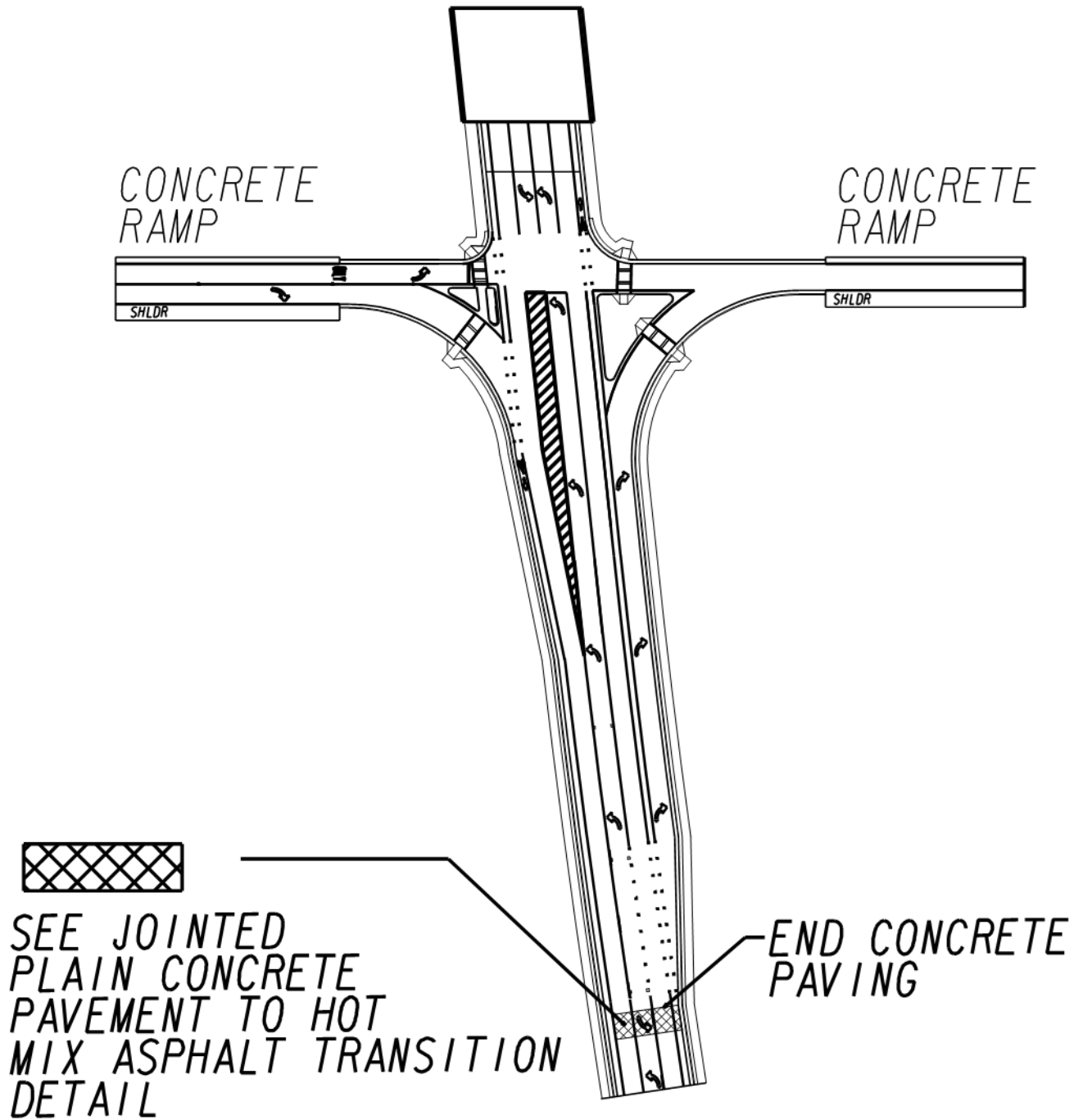

Figure 10.1 Illustration of Typical Interchange Crossroad Paving

Changing Pavement Type or Structure Material Layer Thicknesses at Interchange Ramps

If the interstate mainline is JPCP or HMA the mainline paving can be continued up the ramp to the nearest point for a full width transverse joint between ramp and mainline pavement. Follow transition guidelines previously discussed in this section.

If the mainline is CRCP, hold the edge of pavement through the interchange and the ramp pavement butts up against the mainline CRCP pavement.

Other scenarios, such as where the travel way and shoulder pavement do not match should be discussed at field plan reviews or constructability reviews.

10.3.4 Pavement Subgrade

Lime stabilization

Lime stabilization is used primarily to modify poor quality clay soils in order to improve subgrade support to stabilize a road bed. The recommendation to use lime stabilization will be included in the Soil Survey Summary. With this pay item, lime is quantified and is paid for separately. The Soil Survey Summary will provide a lime application rate for quantification. In terms of the pavement design, when using the pay item for soil-lime treated roadbed, the soil support value (SSV) is changed to that given in the Soil Survey Summary. If the soil-lime treated sub-base pay item is used, this is treated as another layer in the pavement design program which increases the proposed structural number.

Cement stabilized subgrade

This recommendation would be specially made by OMAT.

10.3.5 Pavement Widening

Asphalt Widening

When removing asphalt, it is recommended that no less than half of the existing asphalt lane remain in place. This will allow for a clean longitudinal joint and the joint will not be in the wheel path. If widening an existing lane, the condition of the edgeline should be evaluated. If a poor condition exists saw cut a clean line. The cut should occur a minimum of 1' past the current edgeline. If your project has a Pavement Evaluation Summary (PES), OMAT may provide a recommendation in the PES, if not this should be discussed at the field plan review (FPR). Paved shoulders becoming part of the travel lane should be removed unless the PES recommends they can be retained.

Concrete Widening

When widening concrete, the new concrete is not tied to the old concrete.

Class B Widening Detail

Class B concrete widening can be used when the proposed widening between existing pavement and proposed curb and gutter is 5' or less. Class B concrete is used if the contractor builds the curb and gutter before the proposed widening. If the widening is done before building the curb and gutter, then the full proposed pavement design is used instead of the Class B concrete. The Class B concrete widening is typically used in lieu of and at the same thickness as the proposed pavement base, 25 mm, and 19 mm layers, with the surface course "tying" the pavement together to create a smooth surface.

Pavement Reinforcing Fabric Detail

18" pavement reinforcing fabric is placed at the joint between existing and new asphalt. If the existing asphalt is not being milled or overlaid, then the pavement reinforcing fabric is not used as there would be nothing on the old lane to hold the fabric in place. There are two types of pavement reinforcing fabric. High Strength is only used on the interstate and TP 2 is used on all other roadway.

10.3.6 Pavement Base

See the Pavement Design Manual Appendix I-Allowable Base Material Maps for general information on where the base materials in Table 10.1 are recommended. The Soil Survey Summary will recommend the final pavement base(s) for inclusion into the project. If pavement base alternates are included in a project, the asphalt layers above the base should remain the same between all the alternatives. See Table 10.1 for Approximate Equivalent Thickness based on materials.

Table 10.1. Table of Approximate Pavement Base Equivalent Thickness

Asphaltic Concrete	=	Soil-Cement	=	Graded Aggregate
4 inches (100 mm)	=	6 inches (150 mm)	=	8 inches (200 mm)
5 inches (125 mm)	=	8 inches (200 mm)	=	10 inches (250 mm)
6 inches (150 mm)	=	10 inches (250 mm)	=	12 inches (300 mm)

Graded Aggregate Base (GAB)

Typically GAB is paid for by the ton. It is only paid for by square yard when weighing is inconvenient. (This is typical of projects in the southern districts). The Area Office should be contacted for unit of payment. This can also be a topic of discussion at PFPR. If square yard measurement is specified, the typical sections shall clearly dimension and label the GAB pay limit widths.

A GAB thickness recommended in the Soil Survey is for flexible pavement only such as HMA. See the [Pavement Design Manual](#) Table 11.3 for typical GAB thicknesses based on soil support values (SSV) in Georgia for HMA pavement designs. For GAB under concrete pavement use 8 inches.

Soil Cement Base

The GDOT [Pavement Design Manual](#) recommends that soil cement not be used when new pavement is constructed adjacent to existing pavement.

For projects that have soil-cement set up as the base or base alternate, do not use soil-cement for a reduced depth paved shoulder. For more information see the [Pavement Design Manual](#).

GDOT typically uses the pre-mixed soil-cement base pay item. With this pay item, Portland Cement is quantified and is paid for separately. Providing both pay items pays for the work and for the material. When requested, OMAT will provide the Portland cement by volume for quantification. OMAT will generally recommend a double surface treatment on the Soil Cement Base as a bond breaker to keep reflective cracks from surfacing, which is a separate pay item. When using a bond breaker, this is not part of the structure design but should be included in the pavement design remarks.

Soil Cement Base may have staging issues when there are a lot of intersections that require maintaining access, because of the curing times. This should be discussed with District Construction personnel.

Asphaltic Concrete Base

When the Soil Survey Summary allows for the use of asphaltic concrete base, additional 25 mm Superpave is used to construct the pavement base. The base and the 25 mm layer are built together in accordance with construction guidelines established in Section 400 of the Georgia Standard Specifications, but are shown separately on the design analysis. Asphaltic Concrete should be used as a base material only when the soil support value is greater than or equal to 3.5.

Lime Rock

When the Soil Survey recommendation includes lime rock base in addition to GAB nothing additional is required in the Construction Plans or Pavement Designs. The plans and designs use GAB.

Others

OMAT may recommend other types of bases such as:

- Reclaimed base material
- Full Depth Reclamation (FDR)
- Inverted Bases
- Cement Treated Base (CTB)

10.3.7 Pavement Approval/Re-approval

The pavement approval process will follow those outlined in the [GDOT Publications Policies & Procedures](#), [PDP](#) and [Pavement Design Submission and Approval Process](#). When multiple pavement designs result in the same pavement material and thickness but different over/under design percentages only submit the design with the most under-designed pavement. The design remarks should list everywhere the design is being used. If a separate pavement design is not approved for a crossroad it is assumed the mainline pavement design applies.

Pavement Design needs re-approval by the SPE anytime applicable pavement design input changes. The changes include the following: change in traffic volumes, lane distribution factor, truck percentages, design year no longer correlates to project schedule, or a change in an input value recommended in the Soil Survey Summary or Pavement Evaluation Summary. This could be Soil Support Value (SSV), Regional Factor (RF), Sub-grade Modulus (k) recommended base type/thickness, overlay, milling, etc.

10.3.8 Cross Road Design

If the traffic diagram does not provide specific truck percentages for crossroad, use the mainline truck percentages. If other truck percentages are used clearly indicate where the truck percentages came from when submitting for SPE review and potential approval. If only total truck percentages are proposed (i.e. SU/MU percentages are not provided), use ESAL values found in Table 10.2 when performing the analysis and indicate this in the notes in the pavement design notes.

Table 10.2. User Defined Representative Truck Percentages

Type of Facility	% S.U. Trucks	% M.U. Trucks	Representative 18-Kip ESAL
Rural Interstate Routes	0	100	1.50
	10	90	1.39
	20	80	1.28
U.S. Routes	30	70	1.17
Heavy State Routes and Urban Interstate Routes	40	60	1.06
Medium State Routes	50	50	0.95
	60	40	0.84
Local Collector	70	30	0.73
Light State Routes	80	20	0.62
Secondary System and City Streets	90	10	0.51
	100	0	0.40
Note: "Heavy" State Routes refers to routes having truck percentages of 10% or greater and/or Initial Year One-Way ADT exceeding 5,000 vpd. "Medium" State Routes refers to routes having traffic volumes from 3,000-5,000 vpd.			

10.4 Alternate Pavement Bid Process

10.4.1 Introduction

See the GDOT [Pavement Type Selection Manual](#) for when a project may be recommended for Alternative Pavement Bidding. The SPE reviews and approves the Pavement Type Selection (PTS). All alternate pavement designs need approval from the SPE.

10.4.2 Design & Construction Plan Requirements

Alternate Pavement Design will affect the following areas of the plan set:

- General Notes
- Typical Sections
- Summary of Quantities
- Mainline & Crossroad Plan
- Cross Sections
- Drainage Design
- Pavement Markings
- Staged Construction & Erosion Control

The General Notes drawing section will state the alternate pavement type that is presented in the plans. (i.e. Plans have been designed using alternate 1 and no additional plans will be provided for the other alternates.) This will be chosen based on the highest scoring of the alternates from the Pavement Type Selection report. Mainline plans, crossroad plans, cross sections, pavement markings, staged construction, and erosion control plans will be based on the highest scoring of the alternates from the Pavement Type Selection report. Specific information to some other drawing sections of the plan set is given below.

Typical Sections

Typical sections will reflect all alternates. Each alternate should be clearly labeled as alternate 1, alternate 2, etc. (e.g. alternate 1 is PCC on GAB)

Summary of Quantities

The summary of quantities will include all alternates. Each alternate will be placed on a different plan sheet using the naming convention shown in the typical sections. (e.g. Alternate 1, etc.) This will include all pavement items, pavement markings, approach slab, and other miscellaneous items. Earthwork quantities will only be provided for the alternate presented in the plans/cross-sections.

Drainage Design

Pipe cover should accommodate the thickest pavement section from the alternatives.

10.4.3 Mainline Travel Lane Alternates

See the [Pavement Type Selection Manual](#) for alternate bid policy. When the mainline qualifies for alternate bidding between asphalt and concrete alternates, the crossroads need to have their own design.

10.4.4 Paved Shoulder Alternates

If you have shoulder alternates it will need to be reflected in the typical sections and summary of quantities. Alternates include full/partial depth HMA, PCC, RCC or CRC (but only when used along CRC mainline.)

10.4.5 Base Alternates

Base alternates should be reflected in the typical sections and in the summary or quantities. The base layer in the typical section can be labelled GAB, Soil Cement or 25 mm Superpave. A separate typical section is not required for each alternate.

10.4.6 Quantities & AASHTO Transport Construction Estimate System (CES)

Place all items in CES in one file. The items unique to each alternate should be placed in categories named Alternate 1, Alternate 2, etc. These categories will correspond to the naming convention given in the typical sections.

10.5 Rigid Pavement

10.5.1 Introduction

Rigid Pavement has historically been used in the following areas or situations:

- Ramps
- State Routes adjacent to other rigid pavement
- High truck traffic areas
- Areas with high turning movements
- Areas where future disruption (e.g. maintenance frequency) to traffic must be kept to a minimum

Jointed Plain Concrete Pavement (JPCP) and continuously Reinforced Concrete Pavement (CRCP) designs will be provided by the designer. Any other concrete pavement type will be recommended and designed by OMAT. All designs will need approval from the SPE.

10.5.2 Design Considerations

Pay Item Section

Concrete pavement is paid for by the square yard. Any reinforcing steel, such as tie bars and dowel bars is included in the concrete costs. For CRCP designs lug anchors are required wherever the CRCP begins and ends such as approach slabs, begin and end project, changes in pavement type etc. and are paid for separately in LF. The special construction details for lug anchors can be requested through the Office of Design Policy and Support, Standards and Details section. The below information is commonly missed:

- JPCP is paid for as “PLAIN PC CONC PVMT, CL _ CONC, _ INCH THK”
- CRCP is paid for as “CONT REINF CONC PVMT, CL _ CONC, _ INCH THK”
- Section 439 pay item is typically used for smaller projects (less than 50,000 SY of concrete) and uses either class 3 or High Early Strength (HES).
- Section 430 pay item is typically used for larger projects and uses either class 1 or HES. A temporary concrete plant and field laboratory is set-up by the contractor on the jobsite.

Interlayer

Interlayer is used on interstate mainline and shoulder and interstate ramps between the base and the JPCP to provide a barrier to water entering the base material and construction platform between the GAB and CRCP/JPCP layers. The interlayer is typically 3 inches of 19 mm Superpave but may be recommended thinner or a different material by OMAT. It is also commonly used with JPCP on state routes with high truck traffic volumes and/or percentages. Interlayer is required with the use of CRCP.

Miscellaneous

Concrete pavement should be considered when there is less than 500 ft. between successive bridges with concrete deck surfaces, coordinate with OMAT and discuss at the field plan review.

10.5.3 Constructability

High Early Strength Concrete (HES)

The use of high early strength concrete is determined by the designer. HES allows traffic to be placed on the new pavement sooner, but is more expensive. The use of high early strength concrete should be discussed at constructability reviews and Field Plan Reviews.

Pavement Grinding

Pavement Grinding item and quantity should be added when the staging sequence makes it difficult to achieve a smooth, uniform surface that complies with GDOT specifications. This should be discussed at Field Plan Reviews. This quantity may be an “As Directed by Engineer” quantity.

Base & Interlayer Extension

The concrete paving equipment requires a stable base to drive on, so GDOT typically provides a minimum 2-ft extension of GAB and interlayer (if required) past the edge of the concrete paving operation. This extension is already accounted for in the safety edge (P7) detail, but needs to be shown in the typical sections for other locations (e.g. raised median, curb and gutter or asphalt shoulder on mainline). See Figure 10.2 for an illustration of a typical application. See section 6.5 of the Design Policy Manual to see if the safety edge is required.

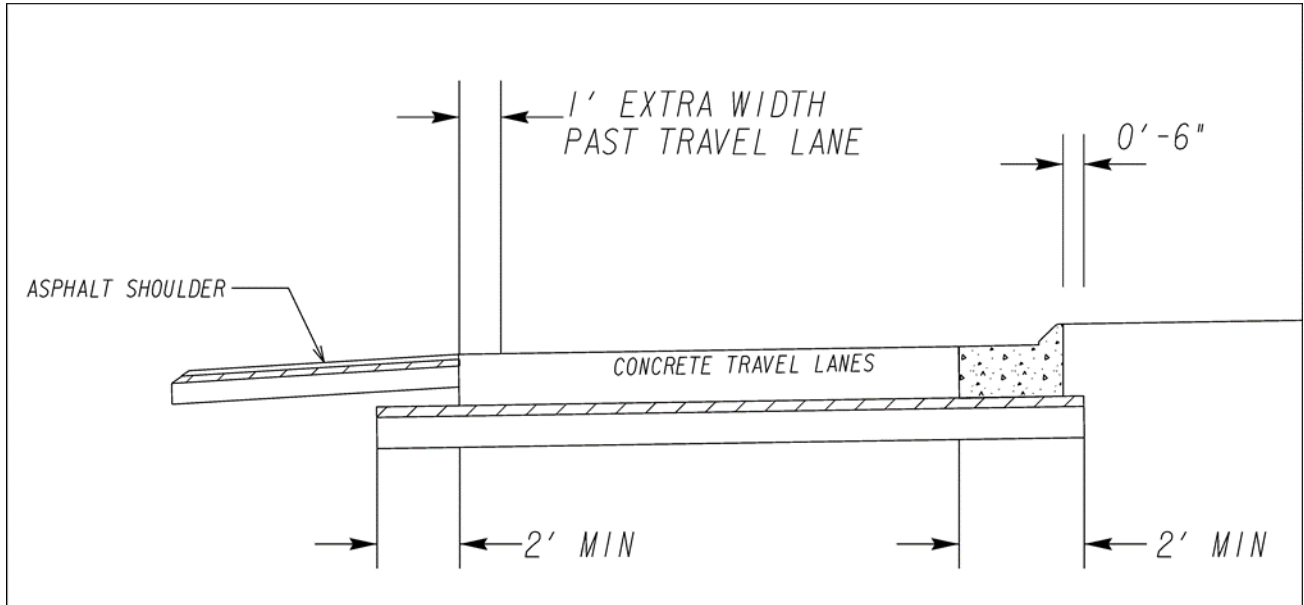

Figure 10.2 Illustration of Typical Base & Interlayer Extension

Paved Mainline and Shoulder

Paved mainlines and shoulders should be squared off when building in concrete. Odd pointed shapes should not be used. Any tapers or shifts should be done with striping. 2-ft is the least amount of width that should be used. See below figure 10.3 for an example illustration. Designers should consider this while staging construction.

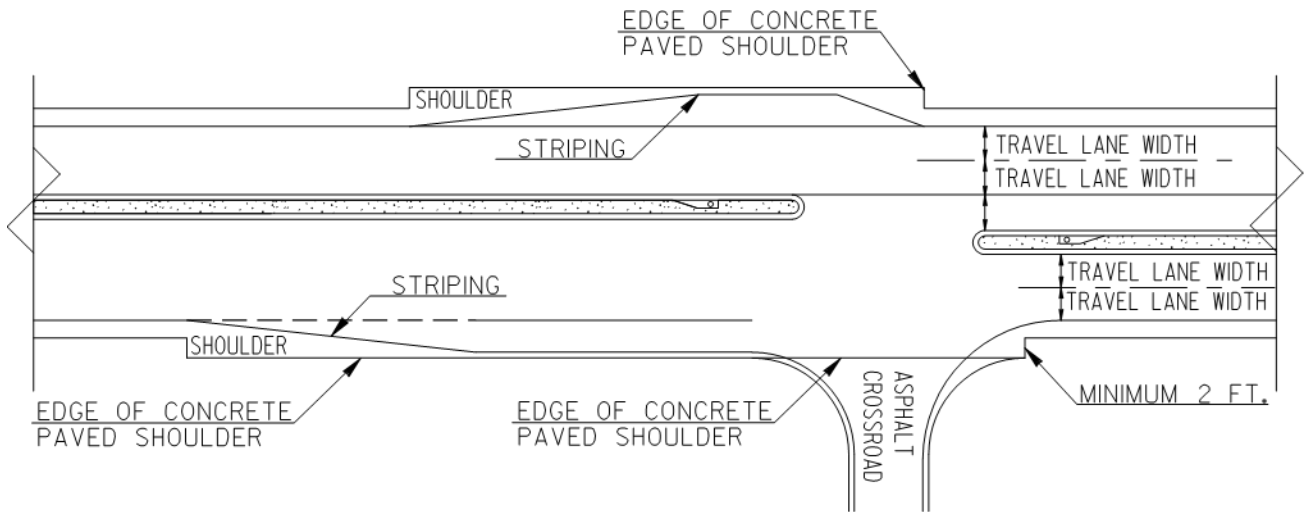

Figure 10.3 Illustration of Concrete Taper

Joint Layout

Refer to GDOT Standard [5046H](#) for joint details for Jointed Plain Concrete Paving. Design of staged construction should include consideration of using pavement construction widths that don't force the final product to have longitudinal joints in the wheel path.

Lane Layout & Design

When the travel lane and shoulders are JPCP and built in the same project, they are tied together. When you don't have a tied shoulder, rigid pavement designs will have an additional foot added to the travel lane and will be striped at the proposed travel lane width. See Figure 10.2.

10.6 Flexible Pavement

10.6.1 Introduction

Types of Flexible Pavement typically used in Georgia:

- Asphaltic Concrete:
 - Stone Matrix Asphalt (SMA)
 - Superpave
 - Open Graded Friction Course (OGFC)
- Surface Treatments
- Micro Surface Treatments or Micro Seals

The typical pavement design layering structure for flexible design is shown in Figure 10.4.

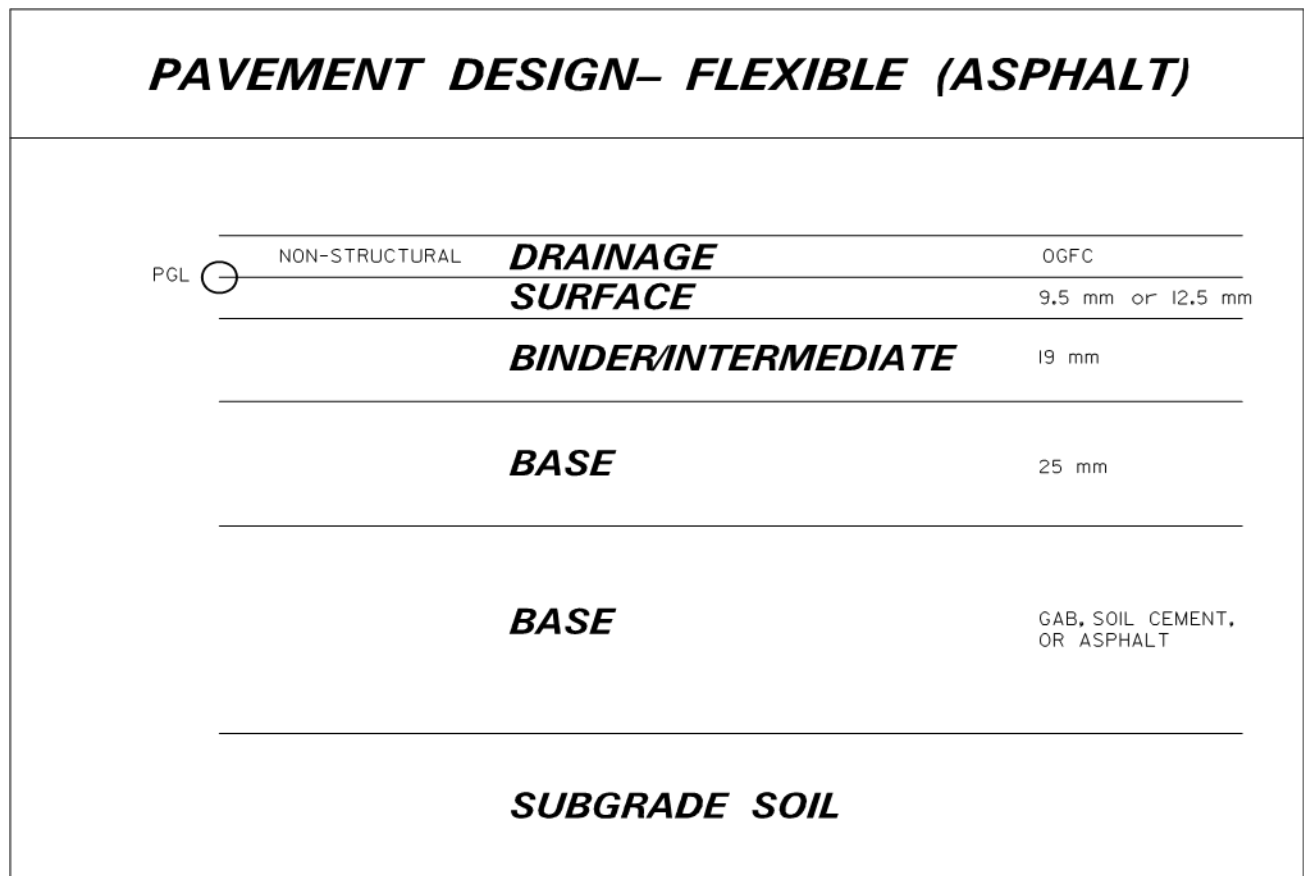

Figure 10.4 Illustration of Typical Flexible Pavement Design

10.6.2 Design Considerations

The [Criteria for Use of Asphaltic Concrete Layer and Mix Types](#) provides guidance for HMA Layers and Mix Types. The surface course aggregate type requirements can be found in GDOT Publications Policies & Procedures [5520-8](#). (e.g. Group 2 Only, Blend 1, Group 1 or 2.)

Flexible Pavement Underdesign Policy

GDOT has a [Revised Flexible Pavement Underdesign Policy Based on State Route Prioritization](#) dated 05/15/2019. These designs will still require approval from the SPE.

Transverse Joints

There should be a section, typically 100 ft. of variable depth milling for tying new pavement to existing pavement. For direct overlay, it is recommended to provide a 100 ft. long section of variable depth milling and overlay with a surface course.

Longitudinal Joints

For the joint between the existing asphalt and new construction, the designer should limit the joint from being within 1 ft. of the wheel path as much as possible.

Crack Mitigation Layer

A crack mitigation layer (a.k.a. asphalt interlayer) may be recommended by OMAT to reduce crack propagation. This allows the stresses and strains to occur in the interlayer without transfer to the above surface layer. Open Graded Interlayer (OGI) or surface treatments with leveling are typically used for this purpose. When a crack mitigation layer is used it is not part of the structure design but should be included in the pavement design remarks.

Drainage Course

When a drainage course is required there are two types that have been recently used in Georgia. They are Open Graded Friction Course (OGFC) and Porous European Mix (PEM). PEM is not being recommended by OMAT at this time. The drainage course overlaps the shoulder by 12" on the inside shoulder and 18" on the outside shoulder. The surface course under the drainage course should be 2" to allow for future micro-milling of the drainage course. The Profile Grade Line (PGL) of the roadway should be placed on top of the surface course and under the drainage course. This placement can be seen on Figure 10.4 and should be labeled on the typical section. Overlays cannot be directly applied on a drainage course.

When replacing just the drainage course, micro-milling is used to remove the existing drainage course. The micro-milling is typically a little deeper than the thickness of the drainage course. When existing striping is being eradicated on a drainage course, the existing drainage course must be milled off and a new drainage course placed before the new striping can be placed. When milling more than the drainage course conventional milling can be used to remove the drainage course and other asphaltic concrete layer(s).

Patching

The need for patching will be recommended in the PES or by the field plan review team. Patching will need to be included in the summary of quantities as an "As Directed by Engineer" quantity.

Tack Coat

Tack coat is needed between the asphaltic concrete lifts but is not required between the GAB/soil cement and asphaltic concrete. Tack coat application rates should be calculated using the values given in the latest edition of the [Georgia Standard Specifications](#), Section 400 or 413 or as supplemented.

10.6.3 Constructability

Temporary Pavement

The difference between temporary pavement and permanent pavement HMA is the lack of lime in the mix. If the temporary pavement is to remain as part of the permanent structure lime is required. This should be noted in the temporary pavement typical sections.

When temporary pavement is retained as part of a permanent pavement the underdesign target shall match that of permanent pavement design. The underdesign target for temporary pavement that will later be removed is 15%.

Terminal Serviceability Index will be lowered to 2.0 for temporary pavement that will later be removed.

The minimum temporary pavement structure is given below based on the time the temporary pavement will be driven on and truck percentage. Final temporary pavement design will need approval from the SPE.

AADTT is the Annual Average Daily Truck Traffic which is calculated by multiplying the AADT by the 24-hr truck percentage.

- ≤ 1 year with an AADTT < 1000
 - 0 inch – Surface Course
 - 4 inches – 19 mm Superpave
 - 0 inch – 25 mm Superpave
 - 6 inches – GAB
- ≤ 1 year with an AADTT ≥ 1000
 - 1.50 inch – 12.5 mm Superpave
 - 2 inches – 19 mm Superpave
 - 0 inch – 25 mm Superpave
 - 6 inches – GAB
- >1 year and an AADTT < 1000
 - 1.25 inch – 9.5 mm Superpave
 - 2 inches – 19 mm Superpave
 - 0 inch – 25 mm Superpave
 - 6 inches – GAB
- >1 year and an AADTT ≥ 1000
 - 1.5 inches – 12.5 mm Superpave
 - 2 inches – 19 mm Superpave
 - 0 inch – 25 mm Superpave
 - 6 inches - GAB

Staged Construction

Designer should provide at least a 1ft. graded shoulder before the shoulder break point to avoid having an unsupported pavement edge.

10.7 Composite Section

Asphalt Overlays of Concrete Paving

Any recommendation for asphalt overlay of concrete paving will come from OMAT. If you have an existing composite section which is to be milled and overlaid with asphalt, then an additional 18" pavement reinforcing fabric should be used at all the original concrete joints (longitudinal and transverse) to prevent these cracks from propagating through the new asphalt overlay. There is no construction detail for this, but a general note should be added to the plans stating "18" Pavement Reinforcing Fabric should be used at all cracks from the original PCC joints." If the joint pattern is unknown, for quantity purposes request a recommendation from OMAT.

10.8 Shoulders

10.8.1 Introduction

Paved shoulder widths (inside or outside) of 4 feet or less should be designed at the pavement thickness of the travel lanes and maintain the same cross slope as that of the adjacent lane. The cross slope of shoulders should be carefully considered by the designer. Designers will need to factor in the width of the paved shoulder, pavement material, and staging. The shoulder slope can be broken if there is an Environmentally Sensitive Area (ESA) or other valid reasons the construction limits should be minimized. See detail S-4 for shoulder paving guidelines. This guideline does not apply to sections of a project where the shoulder is the only new construction.

10.8.2 Design Considerations

Paved shoulder designs do not have to be approved by the SPE unless the shoulder is being used for construction staging traffic or is being built as a future travel lane. In the case of it being used for construction staging traffic, a pavement design analysis would be submitted to the SPE unless the shoulder is the same structure of the travel lane. In the case of a future travel lane it should be the same structure and material (if possible) as the travel lanes, but will not be included in the number of lanes used in the design analysis.

10.8.3 Curb and Gutter

For typical sections that have curb and gutter, the following guideline applies:

- All roadways with a soil support value less than 3.5 will require the use of either GAB or class B concrete under curb and gutter.

10.9 Roundabouts

The approach to pavement design for Roundabouts is handled differently from GDOT's typical intersection pavement design. A typical roundabout pavement design is based off the one way AADT traffic volumes for the highest circulatory volume. With a Roundabout, low speed turning movements increase stresses causing non-typical loading of the pavement due to geometric design of entry and

circulating radii. The higher volume will allow a slightly thicker pavement design and in turn provide more durability and longevity.

Due to the high turning movements, concrete should be considered for all roundabouts. When building the roundabout in concrete, start the concrete pavement at the beginning of the splitter island on each approach to the roundabout. This may not be possible due to staging. At a minimum, extend concrete to the radius of return/outer diameter of the roundabout. If the roundabout is built in asphalt, then a 12.5 mm Superpave with polymer modified surface course should be used regardless of traffic.

10.10 Driveways and Parking Areas

10.10.1 Design Considerations

Driveways

Driveways for traffic generators or areas of heavy commercial vehicles, consideration should be given to using the roadway pavement design structure instead of the normal driveway pavement design structure. On projects with rural shoulders, the driveways should start at the end of the paved shoulder. Driveway profiles over 11% in grade should be constructed in concrete.

10.10.2 Standard Pavement Structure

All driveways that are to be reconstructed shall be placed in kind i.e. asphalt for asphalt, concrete for concrete, and asphalt for earth / gravel drives. Often with urban shoulders, valley gutter is used. This is a separate pay item from the rest of the driveway pavement materials. With concrete driveways the valley gutter thickness should not be less than the concrete thickness. With asphalt driveways 6 inch valley gutter is typically used with residential drives and 8-inch is typically used with commercial drive.

Residential Driveway

Drives shall be constructed using:

- Asphalt– Recycled Asphalt concrete 9.5 mm Type II Superpave (135 lb/sy) or
12.5 mm Superpave (165 lb/sy)
- Graded Aggregate Base, 6" thick
- Concrete- Driveway Concrete, 6" thick

Commercial Driveway

Drives not using the mainline pavement shall be constructed using:

- Asphalt– Recycled Asphalt concrete 9.5 mm Type II Superpave (135 lb/sy) or
12.5 mm Superpave (165 lb/sy)
19 mm Superpave (220 lb/sy)
- Graded Aggregate Base, 6" thick
- Concrete- Driveway Concrete, 8" thick

Parking Areas

GDOT has special scenarios such as Park and Ride lots. These designs should be provided by OMAT.

Intentionally Left Blank

Chapter 11. Other Project Types - Contents

Chapter 11. Other Project Types - Contents.....	11-i
11.1. Preventative Maintenance (PM), Resurfacing, Restoration, or Rehabilitation (3R), and Pavement Reconstruction Guidelines for Federal Aid Projects	11-1
11.1.1. Procedures and Guidelines	11-4
11.1.2. Controlling Criteria for Non-Interstate Systems (GDOT 3R Standards)	11-9
11.1.3. Other Design Considerations for 3R Projects (GDOT 3R Standards).....	11-13
11.2. Special Design Considerations for Other Project Types	11-16
11.2.1. Bridge Fencing Projects	11-16
11.2.2. Bridge Jacking Projects	11-16
11.2.3. Intelligent Transportation System (ITS) Projects	11-17
11.2.4. Signing & Marking Projects	11-17
11.2.5. Traffic Signal Projects	11-17
11.2.6. Noise Abatement Projects	11-18
11.3. Design Elements for Other Project Types.....	11-18
11.3.1. Survey Requirements	11-18
11.3.2. Construction Plans	11-20
11.3.3. Pavement Design	11-20
11.3.4. Environmental	11-20
11.3.5. Earthwork	11-20
11.3.6. Drainage.....	11-21
11.3.7. Guardrail and/or Barrier.....	11-21
11.3.8. Erosion Control Plans.....	11-23
11.3.9. Traffic Signal Plans	11-23
11.3.10. Signing & Markings	11-23
11.3.11. Utilities	11-23
11.3.12. Traffic Control Plans	11-23
11.4. Safe Routes to Schools (SRTS) Projects	11-23
11.4.1. SRTS References	11-24
11.4.2. SRTS Procedures and Guidelines	11-24

Chapter 11. Other Project Types

The Georgia Department of Transportation (GDOT) Road Design Policy Manual is primarily written to provide guidance for the preparation of construction documents for projects involving the new construction or major reconstruction of state roadways. Guidelines, design policies, and practices discussed in this chapter address the following other types of projects:

- preventative maintenance (PM)
- roadway resurfacing, restoration, or rehabilitation (3R)
- pavement reconstruction
- bridge fencing and bridge jacking
- intelligent transportation system (ITS)
- signing and pavement marking
- traffic signal and
- guardrail and/or barrier
- Safe Routes to School (SRTS) projects

The policies in this manual apply to permanent construction of Georgia roads and highways, and different controls and criteria may be applicable to temporary facilities.

11.1. Preventative Maintenance (PM), Resurfacing, Restoration, or Rehabilitation (3R), and Pavement Reconstruction Guidelines for Federal Aid Projects

The purpose of this Section is to provide design guidelines and procedures that cover GDOT's Pavement Maintenance and Resurfacing, Restoration, or Rehabilitation Program. This program includes preventative maintenance (PM); resurfacing, restoration, or rehabilitation (3R); and reconstruction projects per the agreement between the GDOT and the Federal Highway Administration (FHWA).

PM projects are defined as the planned strategy of cost effective treatments to an existing roadway system and its appurtenances that preserves the system, retards future deterioration, and maintains or improves the functional condition of the system without increasing structural capacity.

Preventative Maintenance

The following are examples of preventative maintenance activities:

Pavement

- shoulder repair, including mitigation of edge drop offs
- the addition of paved or stabilization of unpaved shoulders
- installation of milled rumble strips
- asphalt pavement surface preservation that includes activities such as crack sealing, joint sealing, slurry seal, isolated deep patching, etc.

- asphalt resurfacing that includes replacement of the surface lift of dense-grade asphalt, or an open-graded friction course (if present) not to exceed three inches.
- activities related to treatments for Portland Cement Concrete (PCC) pavements (e.g. joint sealing, grinding, dowel retrofit and partial depth repair)
- PCC slab replacement that does not exceed more than 50% of slabs.
- removal or shielding of roadside obstacles

Bridges

- bridge washing and cleaning
- sealing and repairing deck joints
- facilitating drainage
- sealing concrete
- painting
- removing channel debris
- scour countermeasures
- lubricating bearings

Other Items

- guardrail and/or barrier component upgrade
- restoration or extension of drainage systems
- installation or replacement of signs and or pavement markings
- removal of vegetation within the roadway clear zone
- addition and/or replacement of landscaping
- execution of encroachment permits
- obstacles

Guidelines and procedures for PM projects shall be governed by the terms of GDOT's FHWA-approved preventive maintenance agreement.

Resurfacing, Restoration, and Rehabilitation (3R)

3R projects are generally defined as any pavement treatment that is neither PM nor reconstruction. The following are examples of 3R projects:

- resurfacing, restoration or rehabilitation activities related to structural asphalt pavement , including isolated base repair
- mill and inlay deeper than the first dense course, but not including the base course
- activities related to PCC pavement treatments (e.g. continuous slab replacement project that exceed more than 50 percent of the slabs being replaced in any given lane or area)

- widening of lanes and shoulders that does not increase the number of lanes
- selected alterations to vertical and horizontal alignments
- intersection improvements
- passing lane projects
- bridge and culvert rehabilitation or widening that does not increase the number of lanes

Pavement Reconstruction

Pavement Reconstruction projects are generally more complex in project scope and carry a higher cost than PM or 3R projects. The following are examples of pavement reconstruction projects:

- activities related to asphalt pavement reconstruction (e.g. the removal of the entire pavement structure through the base course except for isolated base repair associated with PM or 3R projects)
- activities related to PCC pavement reconstruction (e.g. slab removal and replacement that is continuous throughout the project or when a significant amount of base is being replaced)

ADA Requirement to Provide Curb Ramps

In 2013, the Federal Highway Administration and the US Department of Justice published joint technical guidance clarifying when the ADA requirement to provide accessible curb ramps was applicable to specific types of pavement treatments. The technical guidance classified the specific pavement treatments below as either “Alterations” or “Maintenance”. The lists are not all inclusive.

Alterations: addition of new layer of asphalt, mill & fill / mill & overlay, cape seals, hot in-place recycling, open-graded-surface-course, micro-surfacing / thin-lift-overlay, rehabilitation and reconstruction, new construction.

Maintenance: chip seals, fog seals, scrub sealing, crack filling and sealing, joint crack seals, slurry seals, diamond grinding, joint repairs, spot high-friction, treatments, dowel bar retrofit, pavement patching, surface sealing.

The technical guidance confirms that alterations require the installation of curb ramps at the time of the improvement. Maintenance applications do not require curb ramps at the time of the improvement.

Therefore, any GDOT work or project classified as an “alteration” must install, repair or upgrade curb ramps within the scope of the work or the project. The need to install, repair or update curb ramps should be discussed during the early scoping phase of the work or the project, so that budgets and schedules reflect the requirement.

Where existing physical constraints make it impracticable for altered elements, spaces, or facilities to fully comply with the requirements, compliance is required to the extent practicable within the scope of the project. Existing physical constraints include, but are not limited to, underlying terrain, right-of way availability, underground structures, adjacent developed facilities, drainage, or the presence of a notable natural or historic feature. **Any decision to omit the installation of curb ramp(s) shall require a comprehensive study and the prior approval of a Design Variance from the GDOT Chief Engineer.**

31-inch Height Guardrail Requirements

The Department will require the installation of 31-inch height W-beam guardrail and either NCHRP 350 or MASH accepted end-treatments on GDOT QPL as outlined below:

1. **Resurfacing, Restoration, Rehabilitation (3R) and Pavement Reconstruction:** Where the existing guardrail height is less than 27 $\frac{3}{4}$ inches.
2. **Preventative Maintenance (PM) activities:** Where the existing guardrail height is less than 27 $\frac{3}{4}$ inches. PM activities will either address needed upgrades during the course of work or identify and schedule the needed upgrades with one of the following:
 - a. Future scheduled 3R project,
 - b. Future scheduled pavement reconstruction work,
 - c. Future standalone guardrail project,
 - d. Future programmed roadway project, or
 - e. District Maintenance Contract.
3. **Repairs:**
 - a. The repair of more than 25 ft. (> 25 ft.) of damaged W-beam guardrail where the height is less than 27 $\frac{3}{4}$ inches shall be replaced at 31-inch height. This (25 ft.) represents two 12 $\frac{1}{2}$ -ft W-beam panels or one 25-ft W-beam panel.
 - b. The repair of 25 ft. or less (\leq 25 ft.) of W-beam guardrail may match existing guardrail height.
 - c. If an existing end-treatment is connected to a damaged W-beam guardrail that is less than 27 $\frac{3}{4}$ inches in height, then the end-treatment shall be replaced at 31-inch height.
 - d. Damaged end-treatments shall be replaced with NCHRP 350 or MASH accepted products according to the manufacturer's installation manual. (NCHRP 350 testing requirements for end-treatments will be superseded by the June 30, 2018 MASH testing requirements).
 - e. A decision to replace a whole run of guardrail during a repair will be the discretion of the Department's engineer in the field.

11.1.1. Procedures and Guidelines

Refer to **Figure 11.1.** and the following text to determine appropriate preconstruction process that should be followed for each of the different categories (PM, 3R or reconstruction projects). Preventive Maintenance projects do not need to follow the [Plan Development Process](#) (PDP)¹. However, PM projects on Interstate highways require both a concept meeting and a brief concept report. 3R projects shall follow a Streamlined PDP, which is summarized in **Figure 11.1.** Some exceptions are listed below.

3R projects prepared by the GDOT Office of Maintenance and/or Office of Preconstruction shall follow the PDP with the following exceptions/changes:

- **Chapter 4. Project Planning and Programming**

¹ The GDOT [Plan Development Process manual](#) is available on the GDOT R.O.A.D.S. website at: <http://www.dot.ga.gov/PartnerSmart/DesignManuals/PDP/PDP.pdf>

- Generally, most of this chapter will not apply to 3R projects that are using only lump-sum maintenance funds. However, in all cases, TPro² shall be updated as, as prescribed by Chapter 10 of the PDP.

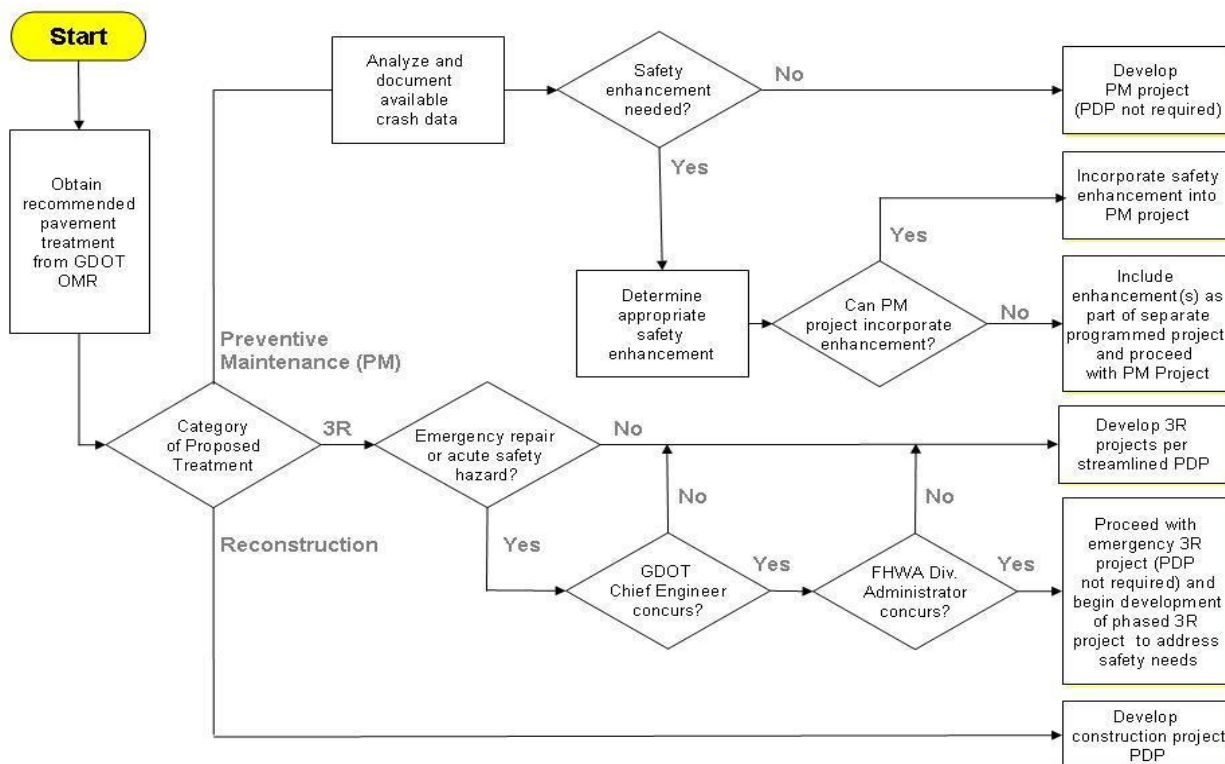

Figure 11.1. PDP Process for PM, 3R, and Reconstruction Projects

- **Chapter 5. Concept Stage**

- 3R projects will not require an initial concept meeting
- To ensure early coordination from other GDOT offices, a concept meeting, report, and solicitation of comments on the report is required. However, some of the PDP's specific requirements for a concept meeting and report may not apply if there are no right-of-way, utility, or environmental impacts
- For 3R projects being developed by the GDOT Office of Maintenance, the Assistant Preconstruction Director will be responsible for distributing the concept report for comments, consolidating comments, recommending approval of the concept report, and forwarding the concept report to the Chief Engineer for approval.

- **Chapter 6. Preliminary Design (If applicable)**

- A *Project Design Data Book* is not required
- The preliminary and final field plan reviews may be combined if recommended by Engineering Services

² Refer to the GDOT [PDP](#) for additional information about TPro, the GDOT Preconstruction Project Management System.

- **Chapter 7. Final Design**
 - If no right-of-way is required, neither the *Location and Design Report* nor the advertising of location approval is required.
- **Appendix D. Design Exceptions and Variances**
 - As intended by the *PDP*, future projects in the Statewide Transportation Improvement Plan, (STIP) and Regional Transportation Plan (RTP) will be considered in the review and approval of design exception/variance requests.

Reconstruction Projects shall follow the Plan Development Process

The geometric and safety guidelines for PM, 3R, and reconstruction projects are summarized in **Table 11.1**.

Table 11.1. Geometric and Safety Related Policies for 3R, PM, and Pavement Reconstruction Projects

Classification	Type of Work	Design Policies	Upgrade Guardrail if not meeting	Update Cross Slope and SE?	Design Variance/Exception Approval Authority
National Highway System (NHS)					
Interstate	Pavement Reconstruction	AASHTO <i>Green Book</i> /Interstate Stds.	MASH	Yes	FHWA
	3R	AASHTO <i>Green Book</i> /Interstate Stds.	MASH	If crash history warrants	FHWA
	PM ⁽³⁾	n/a	MASH	If crash history warrants	n/a
Freeway Non-Interstate	Pavement Reconstruction	AASHTO <i>Green Book</i>	MASH	Yes	GDOT (if PoDi, FHWA)
	3R	AASHTO <i>Green Book</i>	MASH	If crash history warrants	GDOT (if PoDi, FHWA)
	PM ⁽³⁾	n/a	MASH	If crash history warrants	n/a
Non-Freeway	Pavement Reconstruction	AASHTO <i>Green Book</i>	MASH	Yes	GDOT (if PoDi, FHWA)
	3R	GDOT 3R Standards ⁽¹⁾	MASH	If crash history warrants	GDOT (if PoDi, FHWA)
	PM ⁽³⁾	n/a	MASH	Not required	n/a
Non-NHS					
All Roads	Pavement Reconstruction	AASHTO <i>Green Book</i>	MASH	Yes	GDOT
	3R	GDOT 3R Standards ⁽¹⁾	MASH	If crash history warrants	GDOT
	PM ⁽³⁾ - State Route	n/a	MASH	Not required	n/a
	PM - LMIG ⁽²⁾ Work	n/a	n/a	Not required	n/a
<p>Notes:</p> <p>(1) Per AASHTO <i>Green Book</i> except where otherwise stated in Sections 11.1.2. and 11.1.3 of this Manual.</p> <p>(2) LMIG = Local Maintenance & Improvement Grant.</p> <p>(3) Preventative Maintenance (PM) work will either address a needed upgrade or identify the needed upgrade that will be addressed with future scheduled 3R, pavement reconstruction work, stand-alone (guardrail) project, or District Maintenance contract.</p>					

Rumble Strips

The Department will require the placement of rumble strips for 3R and Pavement Reconstruction Projects as defined in Table 11.2 below:

Table 11.2. Rumble Strip Placement

Roadway Type	Rumble Strip Placement
Interstate / Freeway ⁽¹⁾	Continuous, Detail T-25
Rural Shoulder ≥ 4-ft. Paved	Skip Shoulder, Detail T-23B & T-25
Rural Shoulder ≥ 2-ft. and < 4-ft. Paved	Skip Edge Line, Detail T-23A & T-25
Rural Shoulder < 2-ft. Paved	Continuous Edge Line, Detail T-23A & T-25
⁽¹⁾ Where bicycles are NOT allowed	

Rumble strips shall be used as follows:

- for rural shoulder where the design speed is ≥ 40 mph;
- rumble strips are to be the milled-in type; and
- for concrete roadways that may be widened in the future contact the Office of Design Policy and Support for an acceptable alternate to milled rumble strips.

Refer to GDOT Construction Detail T-23A, T-23B, T-23C, and T-25 for drawings showing the placement of the rumble strips. Under special circumstances, GDOT Construction Details T-19 and T-24 provide other applications for various rumble strip/rumble patch devices. **A decision to omit providing rumble strips shall require a comprehensive study by an engineer and the prior approval of a Design Variance from the GDOT Chief Engineer.**

11.1.2. Controlling Criteria for Non-Interstate Systems (GDOT 3R Standards)

Guidelines for non-interstate 3R projects will follow the current edition of the American Association of State Highway and Transportation Officials (AASHTO) *A Policy on Geometric Design of Highways and Streets (Green Book)* for all projects except the controlling criteria listed below will apply.

Design Speed

The design speed shall be equal to or greater than the posted speed. **If the existing roadway does not meet the design speed criteria and cannot be reasonably corrected, a Design Exception must be requested and approved by the Chief Engineer.**

For projects on roadways with no posted speed limit, an appropriate design speed should be selected by the designer. For information on selection of design speed, refer to **Chapter 3. Design Controls, Section 3.3. Design Speed** of this Manual.

Lane Width

Where sufficient right of way exists, it is desirable to provide lane widths that meet AASHTO guidelines, **Where sufficient right of way does not exist and the crash data indicates that the existing lane width contributes directly to the crash history, AASHTO lane widths shall be provided unless a Design Exception (high speed roadways) or Design Variance (low speed roadways) is approved by the Chief Engineer.** If it is not practical to provide adequate lane widths as part of a 3R project, the need for a separate project should be further evaluated by the GDOT Traffic Operations Office and a project programmed if the need is confirmed.

Where lane widths are wider than necessary, the lane width may be reduced to meet minimum AASHTO Green Book criteria. Research has indicated that where a fixed pavement width is present, widening a lane by one foot will often provide a greater benefit than widening a shoulder by the same amount.³

Appropriate safety mitigation measures should be applied where AASHTO Green Book Criteria for lane width cannot be met.

Usable Shoulder Width

The usable shoulder widths for two-lane roadways are determined by functional classification and Average Daily Traffic (ADT). Refer to **Table 11.3**.

³ Gross, F., P. Jovanis, and K. Eccles, *Safety Evaluation of Lane and Shoulder Width Combinations on Rural, Two-Lane, Undivided Roads*, FHWA TECHBRIEF for FHWA publication No. FHWA-HRT-09-032 which is dated May 2009. <http://www.fhwa.dot.gov/publications/research/safety/09032/index.cfm>

Table 11.3 Usable Shoulder Width for Two Lane Roadways

Roadway Classification	ADT < 400	ADT 400 – 2,000	ADT > 2,000 or DHV > 200
Local Road	2-ft.	3-ft.	6-ft.
Collector	2-ft.	4-ft.	6-ft.
Arterial	4-ft.	6-ft.	8-ft.

These minimum widths apply to rural two lane roadways as well as the right shoulder for rural multilane roadways. **A decision to use or maintain a shoulder width that is less than the corresponding minimum width defined in Table 11.3 shall require prior approval of a Design Exception (high speed roadways) or Design Variance (low speed roadways) from the Chief Engineer.**

Where sufficient right of way exists, it is desirable to provide shoulder widths that meet AASHTO guidelines. **Where sufficient right-of-way does not exist and the crash data indicates that the existing shoulder contributes directly to the crash history, AASHTO shoulder width shall be provided unless prior approval of a Design Exception (high speed roadways) or Design Variance (low speed roadways) is given by the Chief Engineer.**

If it is not practical to provide adequate shoulder widths as part of a 3R project, the need to widen the shoulder(s) should be further evaluated by the GDOT Traffic Operations Office and a project programmed if the need is confirmed.

Where shoulder widths are wider than necessary, the shoulder width may be reduced to meet guidelines in **Section 6.5 Shoulders** of this manual. The final paved width should meet guidelines in **Section 9.5.2 Bicycle Facility Design**, if warrants for bicycle accommodations are met.

Appropriate safety mitigation measures should be applied where AASHTO Green Book Criteria for shoulder width cannot be met.

Multi-Lane Roadways

All multi-lane roadways should have a usable shoulder width that matches the current Green Book value required for the classification of the roadway. **A decision to use or maintain a shoulder width that is less than the minimum value shall require prior approval of a Design Exception (high speed roadways) or Design Variance (low speed roadways) from the Chief Engineer.**

Bridge Widths

Geometric design standards shall be in accordance with the AASHTO *Green Book* and the GDOT Bridge and Structures Design Manual. A decision to use or maintain a bridge width that is less than the minimum value will require prior approval of a Design Exception (high speed roadways) or Design Variance (low speed roadways) for either lane width or shoulder width from the Chief Engineer.

Refer to AASHTO Green Book and GDOT Bridge and Structures Design Manual for minimum bridge width values.

In urban sections (with curb), the minimum clear width for all new or reconstructed bridges shall be the curb-to-curb width of the approaches, with the exception of 2-lane, 2-way bridges, where the minimum clear width shall be 2-ft.+TW+2-ft.

Sidewalks shall be provided on bridges where curb and gutter is provided on the approach roadway. The minimum sidewalk width on bridges shall be 5.5-ft.

Bicycle warrants shall be checked for needing accommodation on all new, widened, and retained bridges. Accommodations can be provided on retained bridges where a *bridge deck* is being replaced or rehabilitated and the existing bridge width allows for a wide enough shoulder for bike accommodations, (i.e. \geq 5-ft.) without eliminating (or precluding) needed pedestrian accommodations, reference [Title 23 United States Code, Chapter 2, Section 217, Part \(e\)](#).

The replacement of existing concrete post and open railing systems constructed prior to 1964 shall be evaluated on a case by case basis.

Design Loading Structural Capacity

The structural capacity for existing / retained bridges shall be: HS-15 (MS-13.5). The structural capacity for new bridges shall be: HS-20 (MS-18). Refer to the current [GDOT Bridge and Structures Design Manual](#) for further guidance related to structural capacity. **A decision to use or maintain a structural capacity that is less than required shall require prior approval of a Design Exception (National Highway System) or Design Variance from the Chief Engineer.**

Lateral Offset to Obstruction

Lateral Offset to Obstruction values will follow the guidelines set by *AASHTO Roadside Design Guide*. **A decision to use or maintain a lateral offset to obstruction that is less than required shall require prior approval of a Design Variance from the Chief Engineer.**

Vertical Clearance

A minimum of 14.5-ft. shall be maintained as vertical clearance at all existing structures. Resurfacing shall be performed so as not to violate this requirement. **A decision to use or maintain a vertical clearance that is less than required shall require prior approval of a Design Exception (high speed roadways) or Design Variance (low speed roadways) from the Chief Engineer.**

Horizontal Curve Radius

In cases where AASHTO guidelines are not met, refer to the conditions and corresponding policies listed in **Table 11.4**.

Table 11.4. Horizontal Alignment for Existing Features not meeting 3R Guidelines

Condition	Accident History	Policy
< 10 mph below AASHTO guidelines	Low, compared with statewide average	Retain. The designer shall address and justify existing features to be retained which do not meet 3R guidelines.
< 10 mph below AASHTO guidelines	Directly related accident history compared with statewide average	Correct to AASHTO guidelines or to the highest design speed practicable and request a Design Exception (high speed roadways) or Design Variance (low speed roadways).
> 10 mph below AASHTO guidelines	Not applicable	Correct to AASHTO guidelines if practicable. If not, correct to highest design practicable and request a Design Exception (high speed roadways) or Design Variance (low speed roadways).

If it is not practical to reconstruct a horizontal curve to meet the minimum AASHTO radius as part of a 3R project, the need to reconstruct the horizontal curve should be further evaluated by the GDOT Traffic Operations Office and a project programmed if the need is confirmed.

Appropriate safety mitigation measures should be applied for all horizontal curves where AASHTO Green Book criteria minimum radius cannot be met, and may include one or more of the following:

- widening travel lanes;
- widening and/or paving of shoulders;
- flattening steep foreslopes;
- removing, relocating or shielding roadside obstructions; and
- installing traffic control devices (e.g., speed reduction warning signs, chevrons...).

Safety mitigation measures are particularly important where the curve is unexpected such as when the curve follows a long segment of tangent roadway, where the approach is on a long downgrade, or the curve is not visible to the driver on the approach.

Stopping Sight Distance (SSD) on crest vertical curves

The same policies described in Table 11.4 for horizontal alignment shall apply to SSD on crest vertical curves.

Cross Slope

Pavement cross slope shall be a minimum of 1.5% and desirable 2.0%. Cross slope may be increased to 2.5% in areas where an increase is practicable and justified. For wide pavements, cross slope can be increased with each additional lane width. **A decision to use or maintain a**

cross slope that does not meet the above criterion shall require prior approval of a Design Exception (high speed roadways) or Design Variance (low speed roadways) from the Chief Engineer.

Maximum Grade

A substandard existing grade should be retained unless crash data indicates that the substandard grade contributes directly to the crash history, or where grade changes are made in conjunction with vertical curve reconstruction. If a substandard grade is retained, safety mitigation measures should be considered and applied as appropriate. A substandard grade with no adverse crash history shall not require submission of a design exception or design variance.

If correction of a vertical grade is necessary based on crash history, the corrected grade shall meet AASHTO Green Book criteria or have prior approval of a Design Exception (high speed roadways) or Design Variance (low speed roadways) from the Chief Engineer. In most cases, the correction of a vertical grade will be outside the scope of a 3R project. If this is the case, the need to correct the grade should be further evaluated by the GDOT Traffic Operations Office and a project programmed if the need is confirmed.

Superelevation Rate

- Rural Collectors and Arterials: The maximum superelevation for rural collectors and arterials shall be 10%.
- Urban Collectors and Arterials: The maximum superelevation for urban collectors and arterials shall be 4% to 6%

A decision to use or maintain a superelevation rate that does not meet the above criterion shall require prior approval of a Design Exception (high speed roadways) or Design Variance (low speed roadways) from the Chief Engineer.

Design Exceptions/Variations

Where existing features that do not meet the above controlling criteria are proposed to be retained or constructed, the designer shall submit requests for design exception or design variance to the Office of Design Policy and Support for approval. The request for design exceptions and variances must identify the sub-standard features, give the justification for retention, and describe any proposed mitigation.

The designer shall examine accident data with the objective of identifying causative factors that could be corrected as a part of the project. If physical correction is not feasible or cost effective, mitigation measures must be considered and resolution documented in the request for design exception or variance. The process for submitting design exception and variance requests is outlined in Appendix D of the GDOT *PDP*.

11.1.3. Other Design Considerations for 3R Projects (GDOT 3R Standards)

Design Speed on Roadways with no Posted Speed Limit

If a roadway is paved and does not have a posted speed limit, the designer should select a design speed commensurate with the functional classification and existing geometric features of the roadway, provided such features are not defective. The selected design speed should be consistent with the speeds that drivers are traveling and are likely to expect on the facility. For county roads or

city streets, the designer should coordinate with the local jurisdictional authority on the selection of the posted speed limit and the recommended design speed. Efforts should be made to have the local jurisdictional authority post a speed limit on the road equal to or less than the selected design speed.

The designer should select a design speed as high as practical to attain a desired degree of safety, mobility, and efficiency within the constraints of environmental quality, economics, aesthetics, and other social or political effects.

On unpaved country roads or city streets, the selected design speed shall be 35 mph or greater. A design exception will be required where this is not practical or appropriate.

Shoulder Treatment and Procedures for Passing Lane, Turning Lane, or Lane Addition Projects

GDOT's policies on the required widths of existing shoulders are as follows:

On the widened side:

- Existing shoulders shall be widened to meet AASHTO Guidelines.
- Clear zone requirement for the specific design situation should be followed. Refer to the *AASHTO Roadside Design Guide* for further guidance on clear zone requirements.

On the non-widened side:

- Where sufficient right of way exists, shoulder widths should meet AASHTO guidelines.
- Where sufficient right of way does not exist and the accident data does not indicate that the existing shoulder contributes directly to the accident history, the existing shoulder may be retained.
- **Where sufficient right of way does not exist and the accident data indicates that the existing shoulder contributes directly to the accident history, AASHTO width shoulders shall be provided unless a Design Exception (high speed roadways) or Design Variance (low speed roadways) is requested and approved.**

Guardrail, End Treatments, and/or Barrier

Guardrail, end treatments, and/or barrier at bridge ends within the project limits shall be upgraded to meet current AASHTO length of need requirements and NCHRP 350 or MASH. The designer shall evaluate the need for guardrail and/or barrier at other locations with existing warrants and consideration should be given for correction consistent with existing warrants. The designer should also take into account accident history when considering the need for additional guardrail and/or barrier.

Existing guardrail, end treatments and/or barrier shall be evaluated under current warrants and if warranted, upgraded to meet current AASHTO length of need requirements and NCHRP 350 or MASH. If an existing guardrail, end treatments and/or barrier are not warranted, it shall be removed.

Where it is determined that guardrail, end treatments, and/or barrier is to be replaced or installed, the additional shoulder width defined as T in [GDOT Construction Standards](#)⁴ shall be obtained. In some cases, obtaining the T distance may require placing guardrail and/or barrier over a portion of the existing shoulder, which would thus reduce the usable shoulder width. If this occurs, the controlling criteria described in Section 11.1.2. of this Manual shall apply, and a design exception (high speed roadways) or design variance (low speed roadways) will be required if the minimum usable shoulder width cannot be maintained.

Drainage Structures

All minor drainage structures shall be extended to avoid encroachment on the minimum shoulder widths as described in Section 11.1.2. of this Manual or the prevailing existing shoulder width, if it is greater.

Major drainage structures shall be evaluated on a case by case basis. Major drainage structures must be extended, where necessary, to achieve the minimum (3R) shoulder widths. Where such structures encroach on existing shoulders, but are beyond the minimum widths, the designer should consider extensions or the installation of guardrail and/or barrier.

Delineation (Advance Warning Signs)

Delineation can be especially effective where minimum or less than desirable geometric features are involved. Since 3R projects often involve such features, GDOT allows liberal application of delineation techniques. Bridges narrower than the approach roadway and sharp curves should be delineated using reflective delineators, chevron alignment signs, or other appropriate devices.

Signs and Pavement Markings

The designer should include standard signing and pavement markings in accordance with the current edition of the [MUTCD](#), where practical.

Railroad grade crossings shall be treated in accordance with current criteria. Where active protective devices are needed, they may be installed as a separate project under the Rail-Highway Crossing Improvement Program.

⁴ GDOT Construction Standards are available online in English and Metric units at: <http://mydocs.dot.ga.gov/info/gdotpubs/ConstructionStandardsAndDetails/Forms/AllItems.aspx>

Americans with Disabilities Act (ADA)

All facilities within project limits shall be in compliance with the Americans with Disabilities Act (ADA) requirements⁵ to the maximum extent practicable within existing physical constraints and project scope. Existing physical constraints include, but are not limited to, underlying terrain, right-of-way availability, underground structures, adjacent developed facilities, drainage, or the presence of a notable natural or historic feature. **Any decision to not comply with ADA requirements shall require a comprehensive study and the prior approval of a Design Variance from the GDOT Chief Engineer.**

11.2. Special Design Considerations for Other Project Types

GDOT determines the need for projects other than the traditional roadway project. The following section discusses design guidelines that are intended to provide for a uniform design approach for these types of stand-alone projects. These guidelines are not intended to replace the Plan Development Process or to be a comprehensive or detailed manual for the design of these facilities, but guidelines for designers in preparing plans for these other project types. In many cases the intent of the project is clear and the designer should strive to achieve the purpose and design intent of the project within the context of earlier chapters of this Manual. Each topic contains the GDOT resource office with the most experience with a type of non-traditional, stand-alone project to contact for additional information.

Guidelines for the following types of projects are included in this section:

- bridge fencing projects;
- bridge jacking projects;
- ITS projects;
- signing and marking projects; and
- noise abatement projects.

11.2.1. Bridge Fencing Projects

The resource office for bridge fencing projects is the GDOT Office of Bridge Design.

The primary purpose of a bridge fencing project is to create a raised barrier that will deter persons from dropping or throwing objects from the bridge onto vehicles or pedestrians below the bridge. The raised barrier on bridge fencing projects is typically a fence that is added to an existing bridge. The project limits should be defined as the extent required to accommodate the bridge fencing. Standard fence details should be utilized whenever possible.

11.2.2. Bridge Jacking Projects

The resource office for bridge jacking projects is the GDOT Office of Bridge Design.

⁵ Visit the following FHWA web page for additional information relating to Americans with Disabilities Act (ADA) requirements http://www.fhwa.dot.gov/environment/transportation_enhancements/guidance/te_ada.cfm

The primary purpose of a bridge jacking project is to raise an existing bridge to correct a deficient vertical clearance or in anticipation of a change in the existing feature underneath the bridge that would cause a deficient vertical clearance.

Roadway approaches to the existing bridge should be designed to account for the elevation difference from raising the bridge. The project limits should be defined as the extent required to accommodate the bridge jacking.

Upgrading major roadway items within the project limits to current standards is not required. In addition, bridge widths and shoulders that do not meet current standards are not required to be upgraded with the bridge jacking project.

Minor design elements within the project limits of the bridge jacking project should be upgraded to current standards. Minor roadway elements include such items as: guardrail, signing and marking, etc.

Major design deficiencies within the project limits and minor design deficiencies outside the project limits should be noted and reported to the GDOT Office of Planning, which may then consider adding a future project to the current GDOT construction work plan. Bridge deficiencies noted in the field should be reported to the GDOT Office of Maintenance immediately.

11.2.3. Intelligent Transportation System (ITS) Projects

The resource offices for ITS Projects are the GDOT Office of Traffic Operations (concept) and the GDOT Office of Traffic Safety and Design (design).

The primary purpose of an ITS project is for congestion mitigation or traffic management. ITS projects include the design of systems of real-time traffic conditions sensors, surveillance devices, traffic control devices, and motorist information devices. These systems may be designed for installation along an existing roadway corridor as a stand-alone project, or for inclusion into a project for other improvements to a roadway corridor.

The installation of ITS devices should not interfere with or affect the visibility of the existing signing or sight distance. Where conflicts are unavoidable, the ITS plans will include replacement signing meeting the standards and guidelines in the [MUTCD](#) and meeting GDOT standard installation details.

11.2.4. Signing & Marking Projects

The resource office for signing and marking projects is the GDOT Office of Traffic Safety and Design.

The primary purpose of a signing and marking project is to provide stand-alone signing and marking improvements. For interstate facilities, FHWA requires all interstate safety features be upgraded to current standards within the project limits. For non-interstate projects, generally other items that do not meet current standards will not be addressed on these projects.

11.2.5. Traffic Signal Projects

The resource office for Traffic Signal Projects is the GDOT Office of Traffic Safety and Design.

The primary purpose of a Traffic Signal Project is to provide a traffic signal design for at-grade intersections. The majority of projects will be for the replacement and upgrade of obsolete

equipment at intersections with existing signals, but this type of project may also be for the design of a new traffic signal.

Geometric improvements such as turn lanes are often included in traffic signal projects, but only to the extent to provide the efficient operation of the signal.

Substandard radius returns on the side streets and storage/taper lengths shall be improved wherever feasible.

Raised concrete islands should be considered during design to facilitate pedestrian movements as necessary.

For skewed angle intersections, turning-radius templates for an appropriate design vehicle shall be used to determine the appropriate opening. The width of the side street shall also be considered in determining the length of the median opening.

11.2.6. Noise Abatement Projects

The resource office for noise abatement projects is the GDOT Office of Environmental Services (OES). Refer to Policy and Procedure 4415-11, *Highway Noise Abatement Policy for Federal Aid Projects* for further guidance relating to noise abatement.

11.3. Design Elements for Other Project Types

11.3.1. Survey Requirements

Typically field surveys shall be considerably more limited with these other projects. Prior to commencing field surveys, the design team shall hold a pre-survey meeting and/or an onsite inspection to determine surveying requirements. Maximum use shall be made of "as-built" construction plans in order to minimize the requirements for collection of field data. As-built drawings, however, shall be verified before relying on them for accurate representation of existing conditions.

Limits of surveys should be determined on a case by case basis prior to the start of surveys. The limits of surveys will depend upon the type of project.

Bridge Fencing Projects

For bridge fencing projects, survey sketches of each site are typically adequate as a database. The designer or design team member can perform the bridge sketches, noting the number of lanes, width of sidewalk, length and type of guardrail, etc.

Each bridge should be treated as a stand-alone location, with no relationship to other bridges in the project corridor, except where bridges are close enough together to affect the design. Project-length horizontal or vertical survey controls are not necessary.

Bridge Jacking Projects

Designers should communicate with the District office and verify there is not another project planned for each bridge jacking location to determine if the bridge jacking should be included in that project and not as a separate project.

Bridge Jacking Project limits will depend upon the amount of bridge raising and the impact to each roadway approach anticipated and the topography of the side slopes. Field surveys should generally include, but not be limited to:

- existing bridge features
- geometry
- digital terrain model (DTM)
- existing right-of-way (in the absence of right of way plans or visible markers, the designer may assume that the fence is the right-of-way line.)
- drainage structures within the project limits (curb & gutter, catch basins, manholes, median drop inlets, cross culverts, side drain pipes etc.)
- existing guardrail
- driveway locations
- utility poles and strain poles
- signage
- other significant topographic features

ITS Projects

When an ITS project is included in other roadway improvement activities, the field survey detail will be determined by the requirements of the roadway work. However, it will be necessary for the designer to obtain detailed field information at the location of the support structures required for dynamic message signs (DMS), camera support poles and other field devices such as junction boxes. Detailed topographic diagram information that includes the location of existing signs, guardrail and drainage structures is essential. Project-length horizontal or vertical survey controls are generally not necessary. Limits of surveys will be determined by the scope of the project or by the project design where the ITS devices are a supplement to other work proposed.

Signing and Pavement Marking projects and Traffic Signal projects

Project-length horizontal or vertical survey controls are not necessary, except in areas where sign/signal sight distance is an issue.

Necessary control should be determined at a pre-survey site visit. The limits of surveys will depend upon the length of project and the topography of the roadway. Field surveys should generally include but not be limited to:

- existing geometry of the roadway
- existing right-of-way (in the absence of right of way plans or visible markers, the designer may assume that the fence is the right-of-way line.)
- drainage structures within the project limits (curb & gutter, catch basins, manholes, median drop inlets, cross culverts, side drain pipes etc.)
- existing guardrail

- driveway locations
- utility poles and strain poles
- signage
- bridges
- other significant topographic features

The design database shall include a schematic diagram of each roadway's geometry and significant features instead of the highly detailed mapping normally required for roadway project design. Cross sections are not required for either signing and marking projects or traffic signal projects. However, if additional safety features are to be upgraded with the project, the project manager and designer should determine whether cross sections are warranted to accomplish the design. If required, ground slopes outside existing roadways shall be provided at 50-ft. to 100-ft. intervals, as deemed appropriate by terrain conditions. Cross sections shall only be provided at areas requiring significant excavation or embankment, and may be substituted with "original plan" or "as-built" templates as long as accurate earthwork estimates can be determined.

The designer shall use the ground survey data or template information to estimate earthwork quantities and to determine construction limits. In most cases, cross sections will not be required for medians, unless conditions warrant (e.g., split profile, drainage structures that may require adjustment or unusual circumstances).

Noise Abatement Projects

For noise abatement projects, necessary control should be determined at a pre-survey site visit. The limits of surveys and cross sections will depend upon the length of project, the topography of the roadway and ground slopes between the right of way and limits of roadway.

11.3.2. Construction Plans

Unless noted otherwise, all of these other projects will be developed through the streamlined *PDP* or similar process. The respective resource office, in consultation with Engineering Services and the project manager, will determine the appropriate process.

11.3.3. Pavement Design

Where required, it is anticipated that most pavement designs will consist of milling, overlay and leveling. Pavement designs will be provided and/or approved by the GDOT Office of Materials and Testing upon completion of the existing pavement analysis and soil survey.

11.3.4. Environmental

It is expected that most sites will involve a NEPA Categorical Exclusion (CE). The GDOT Office of Environmental Services shall be notified as soon as possible of any anticipated impacts to existing waterways, including streams and wetlands.

11.3.5. Earthwork

If earthwork is required, normal standards shall apply; however, because earthwork is generally minimal, the earthwork shall be let as "Grading Complete - Lump Sum." The designer should

calculate earthwork volumes, but no quantities shall be shown in the plans. Removal of vegetation within the clear zone shall be included within the project limits.

11.3.6. Drainage

If drainage is required, normal standards shall apply. Existing drainage structures in conflict with the proposed improvements should be extended or relocated in order to maintain adequate drainage. Existing drainage patterns shall not be altered significantly without justification.

11.3.7. Guardrail and/or Barrier

At locations with existing guardrail to be retained, the designer shall determine if the guardrail meets current GDOT standards and NCHRP 350 or MASH. All guardrail, and/or guardrail terminals, or other end treatments within the project limits that do not meet current GDOT standards or NCHRP 350 or MASH will be replaced. See Figure 5.1 for an illustration of standard guardrail placement.

If the GDOT standard offset (useable shoulder +2-ft.) cannot be met, it is desirable to provide the “shy-line” distance between the edge of traveled-way and the face of barrier as described in the AASHTO RDG, table 5-7. However, it is not a controlling criterion for barrier placement. In cases where the cross section is restricted (e.g. mountainous regions) you may install 9-ft. posts on the shoulder break and maintain a minimum 18-in. lateral offset between the edge of traveled-way and face of barrier. See **Figure 11.2** for illustrations of guardrail placement options in areas with restricted right of way and limited shoulder widths. **A decision to use an offset value less than 18-in. shall require a comprehensive study by an engineer and the prior approval of a Design Variance from the GDOT Chief Engineer.**

In locations where the guardrail extends outside the project limits, the designer shall determine if the new guardrail should tie into the existing guardrail or whether the entire run of existing guardrail should be replaced and the project limits extended.

Figure 11.2

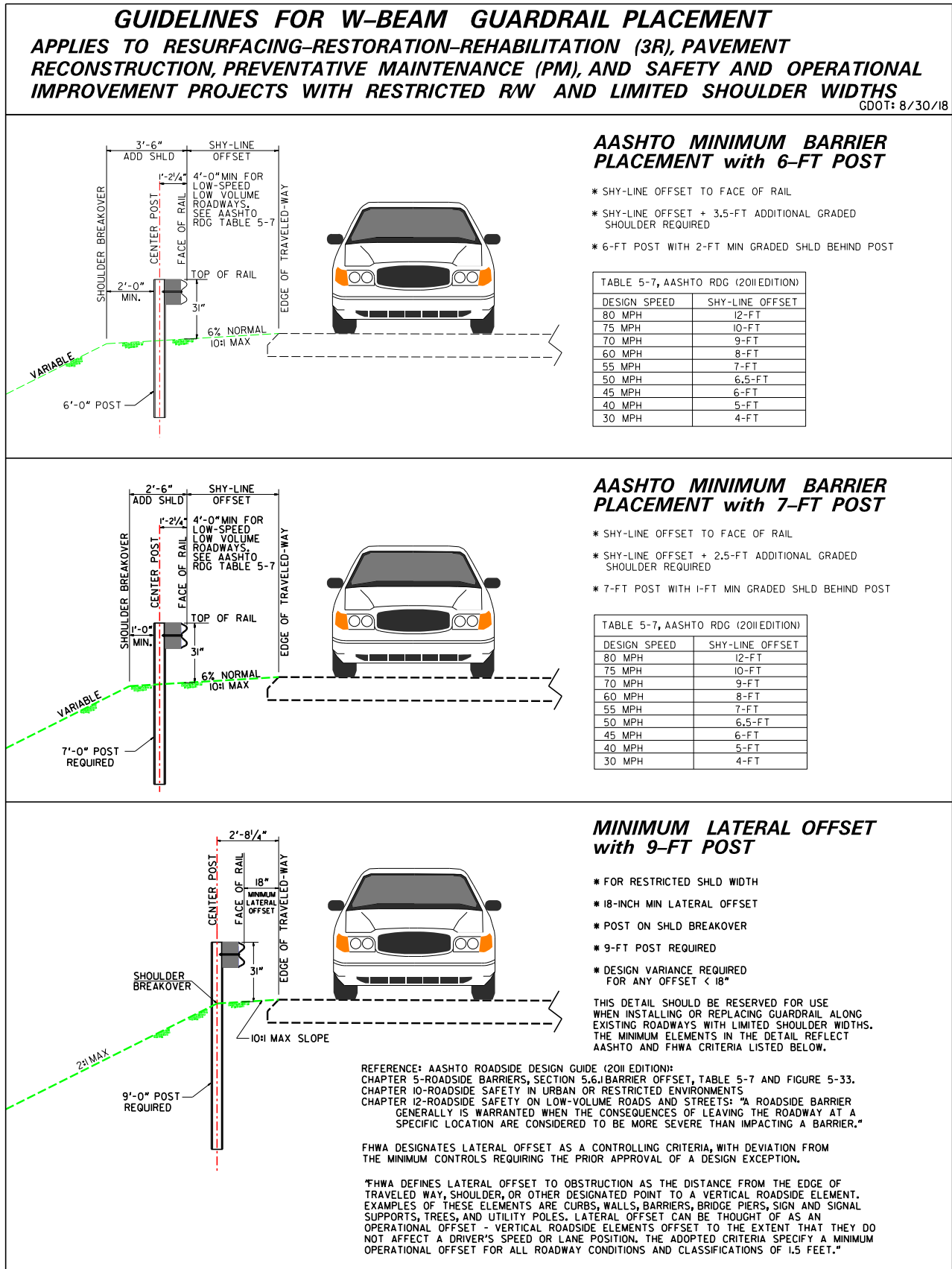

11.3.8. Erosion Control Plans

Where required, erosion control items shall be shown clearly on the construction plan sheets. Typically these other projects do not require separate Comprehensive Monitoring and Erosion Control Plans unless any one site within the project involves land disturbance of more than one acre.

11.3.9. Traffic Signal Plans

The designer shall notify the GDOT Office of Traffic Operations of any anticipated impacts to existing traffic signals.

11.3.10. Signing & Markings

All signs located within the project limits shall be removed and replaced unless otherwise directed. The plans should note that all signs and pavement markings shall be in accordance with *MUTCD* and GDOT standards. In event that *MUTCD* requirements or guidelines conflict with GDOT policy, GDOT policy shall take precedence.

For bicycle lanes and bicycle shoulders, signs and pavement marking shall be replaced in kind.

11.3.11. Utilities

The designer shall coordinate with the GDOT Office of Utilities and the District Office Utilities Engineer regarding the location of utilities. Base plan sheets shall be submitted at the earliest possible time in order to facilitate obtaining existing utilities information from utilities owners. It is anticipated that no significant public utilities relocations or adjustments will be required.

11.3.12. Traffic Control Plans

In most cases, traffic control plans are not required. Standard details for traffic control should be utilized.

11.4. Safe Routes to Schools (SRTS) Projects

The [Federal Safe Routes to School \(SRTS\) program](#) was created by Section 1404 of the Safe, Accountable, Flexible, Efficient Transportation Equity Act: A Legacy for Users (SAFETY-LU), which was signed into public law (P.L. 109-59) on August 10, 2005. As a result of this legislation, every state now has dedicated dollars to help with infrastructure improvements (e.g. new sidewalks and traffic calming measures) and non-infrastructure activities to encourage and enable students to walk and bicycle to school.

The SRTS infrastructure program, administered by the Federal Highway Administration (FHWA), is intended to promote walking and bicycling by students living in a two-mile radius of schools. The desired outcome of the SRTS infrastructure program is to improve the health and well-being of children by enabling and encouraging them to walk and bicycle to school.

GDOT's programmed SRTS projects have very limited funding and short project schedules, therefore it is of utmost importance for all internal and/or external team members to provide the most productive and efficient project possible. In keeping with the [Every Day Counts](#) initiative, SRTS projects should use low-cost, innovative design aimed at shortening project delivery, enhancing safety and protecting the environment wherever possible. Because of the nature of these

projects, flexibility is encouraged and there are some steps or processes in the PDP that may be shortened or omitted. (See **Section 11.4.1. - SRTS Procedures and Guidelines**)

SRTS projects typically involve sidewalk construction/reconstruction, crosswalk additions/upgrades, traffic calming measures or other facilities within the existing public right of way near schools. Design of these facilities must comply with the Americans with Disabilities Act (ADA) standards, Section 504 of the Rehabilitation Act, the Architectural Barriers Act, and any other applicable laws or regulations relating to accessibility, to the maximum extent feasible within the scope of the project.

The feasibility meant by this standard is a physical possibility only. A public agency is exempt from meeting the ADA standards where physical terrain or site conditions restrict constructing or altering the facility to the standard.

11.4.1. SRTS References

Designers should be creative and flexible in developing solutions that promote accessible travel to and from schools. Some resources for guidance are listed below:

- GDOT Design Policy Manual, [Chapter 9 Complete Streets](#)
- GDOT [Context Sensitive Design Manual](#) (available in R.O.A.D.S.)
- AASHTO [A Guide for Achieving Flexibility in Highway Design](#)
- AASHTO [Guide for the Planning, Design, and Operation of Pedestrian Facilities](#)
- AASHTO [Guide for the Development of Bicycle Facilities](#)
- AASHTO [Roadside Design Guide](#)
- US Access Board [Public Right of Way Access Guidelines](#) (PROWAG)
- SRTS Guide (FHWA and others online document):
<http://guide.saferoutesinfo.org/index.cfm>
- State SRTS Coordinator: srts@dot.ga.gov
- GDOT's SRTS website: <http://www.dot.ga.gov/InvestSmart/Funding/Pages/SRTS.aspx>

11.4.2. SRTS Procedures and Guidelines

SRTS projects are considered Minor Projects and will follow a Streamlined Plan Development Process (PDP), which is summarized below by applicable PDP chapter.

- **Chapter 5. Concept Stage**
 - SRTS projects will not require an initial concept meeting.
 - SRTS projects cannot have any right of way or easement acquisition. All construction and land disturbing activities shall occur entirely within the existing, publically owned right of way.
 - To ensure early coordination from other GDOT offices, a concept meeting, field inspection, concept report, and solicitation of comments on the report is required. However, some of the PDP's specific requirements for a concept meeting and report may not apply since these are not roadway projects.

- The Limited Scope Project Concept Report template should be used for concept reports.
- The Design Policy Engineer will forward the concept report to the Director of Engineering for approval. The Chief Engineer is not required to sign or approve SRTS concept reports.
- A *Project Design Data Book* is not required.
- **Chapter 6. Preliminary Design**
 - The NEPA documentation level will be a Categorical Exclusion (CE) or Programmatic Categorical Exclusion (PCE). A four to six month time frame is expected for this process on SRTS projects. The GDOT Office of Environmental Services should be notified as soon as possible of any anticipated impacts to existing waterways, including streams and wetlands.
 - Surveys and Mapping will be considerably more limited on SRTS projects. The surveying/mapping requirements will be determined during the field inspection portion of the concept team meeting. The design database will include a schematic diagram of the geometry and significant features instead of the highly detailed mapping normally required for roadway project design. Cross sections will not be required unless there are locations of significant excavation or embankment. Earthwork will be shown and let as Grading Complete – Lump Sum.
 - Soil Surveys are not required for SRTS projects due to the normally minor amount of earthwork involved on these projects.
 - An approved pavement design is not required for SRTS projects. If any new pavement is proposed, it will typically be limited to milling, surface course overlay, and leveling.
 - Construction plans should utilize 8-1/2" x 11" sheets if possible. If legibility is an issue at that size, 11" x 17" sheets should be used.
 - Utility locations and relocations will be shown on the construction plan sheets. Separate Utility Plans are not required for SRTS projects. However, the designer will coordinate with the GDOT Office of Utilities and District Utility Engineer regarding location of existing utilities within the project limits. Sidewalk or other facility design should avoid existing utilities wherever possible. For example, sidewalk alignment can vary and route around utilities as much as feasible. Utility relocations should be avoided if at all possible.
 - Signing and Marking will be shown on the Construction Plans.
 - New Signals or modification to existing signals and associated details will be shown on separate sheets.
 - A separate, formal Constructability Review is not required. Constructability issues should be addressed during the field inspection portion of the concept team meeting.
 - New bridges, bridge widenings or structural retaining walls and associated details will be shown on separate sheets.

- If drainage is required, normal standards will apply. Existing drainage structures in conflict with the proposed improvements should be extended or replaced in order to maintain adequate drainage. Existing drainage patterns shall not be altered significantly without justification. It should be noted that curb and gutter is not required in order to construct sidewalk. Construction of new, closed drainage systems should be avoided if at all possible.
- Where required, erosion control items shall be shown clearly on the construction plan sheets. Typically, these projects do not require separate Comprehensive Monitoring and Erosion Control Plans unless any one site involves land disturbance of more than one acre.
- Staging Plans are not required on SRTS projects.
- The preliminary and final field plan reviews will be combined for SRTS projects.
- **Chapter 7. Final Design**
 - Final Design will be combined with Preliminary Design.
- **Appendix D. Design Exceptions and Variances**
 - Generally, SRTS projects will not require Design Exceptions or Design Variances since the FHWA Controlling Criteria and GDOT Standard Criteria would typically apply mainly to roadway projects.

Chapter 12. Stage Construction - Contents

- Chapter 12. Stage Construction - Contents 12-i
- 12.1. Overview12-1
 - 12.1.1 Principles.....12-1
 - 12.1.2. References12-1
- 12.2 Project Types12-3
 - 12.2.1. General.....12-3
 - 12.2.2. When are Staging Plans Normally Required?12-3
 - 12.2.3. When are Staging Plans Normally Not Needed?12-4
- 12.3. Plan Development Requirements12-4
 - 12.3.1. Concept Report12-4
 - 12.3.2 Preliminary Plans12-6
- 12.4 Design Considerations12-11
 - 12.4.1. Earthwork12-11
 - 12.4.2. Drainage.....12-11
 - 12.4.3. Erosion and Sediment Control12-12
 - 12.4.4. Pavement12-12
 - 12.4.5. Temporary Concrete Barriers and End Treatments12-13
 - 12.4.6. Traffic Control.....12-14
 - 12.4.7. Utilities.....12-16
 - 12.4.8. Structures12-17
 - 12.4.9. Post-construction BMP's/Water Quality Features12-18
 - 12.4.10. Lighting12-18
 - 12.4.11. Railroads.....12-18
 - 12.4.12. Common Problems12-19
- 12.5. Acknowledgements12-19

Chapter 12. Stage Construction

12.1. Overview

The purpose of this chapter is to provide general design guidance and typical practices for developing stage construction plans. It is important to identify constructability issues early in the design process to ensure that the design provides optimal final geometrics while addressing the need to maintain traffic. Minor projects that have little or no effect on traffic do not require staging plans. The level of detail should be coordinated with GDOT District Construction, other GDOT offices as needed and the Project Manager. The primary goal is high quality buildable projects that provide adequate staging plan detail.

12.1.1 Principles

- Develop a staging approach as early as possible in the plan development process.
- Provide a clear, logical, and concise planned order which shows that the project is constructible.
- Staging plans must accurately consider both horizontal and vertical components, as well as drainage, structures, available right of way, traffic shifts (including through and turning movements) etc.
- Plans should maintain access and mobility for the travelling public (including pedestrians) during construction.
- Utility relocation timing and sequence should be taken into consideration.
- Stage construction sequence should match the phasing for National Pollution Discharge Elimination Systems (NPDES) Erosion Sedimentation & Pollution Control Plans (ESPCP)
- Consideration should be given to the Environmental Green Sheet requirements.

12.1.2. References

- **Standard Specification** – A Specification published in the current GDOT Standard Specifications–Construction of Transportation Systems (current edition).
- **Supplemental Specification** – A change or addition to the Standard Specifications and is approved for use on all Projects.
- **Special Provision (SP)** – Additions or revisions to the Supplemental Specifications applicable to all projects. <http://www.dot.ga.gov/PS/Business/Source>
- **Project Specific Special Provisions** – Additions or revisions to the Standard Specifications, Supplemental Specifications, or Special Provisions, applicable to a specific Project. A Project Specific Special Provision can be identified by the PI Number and County in the title block. This includes Special Provision 150.
 - The two project specific special provisions below are commonly needed on most projects:

- **Special Provision 150.6**– this contract special provision provides traffic control information. Coordination with the GDOT Office of Construction is required for the review and approval of this document prior to letting.
- **Special Provision 108.08** – this contract special provision is to be reviewed and approved by GDOT Office of Construction which provides details for penalties if certain conditions are not met by the contractor.
- **Manual on Uniform Traffic Control Devices (MUTCD) latest version** – provides traffic signing, marking, and traffic operation requirements.

<https://mutcd.fhwa.dot.gov/> FHWA, 2009.

- **Plan Presentation Guide (PPG) latest version** –
http://www.dot.ga.gov/PartnerSmart/DesignManuals/Plan/Plan_Presentation_Guide.pdf
(Sections 19 & 20) provide information related to plan production requirements.
- **Electronic Data Guidelines (EDG) latest version** –
http://www.dot.ga.gov/PartnerSmart/DesignManuals/ElectronicData/Electronic_Data_Guidelines.pdf

(Sections 19 & 20) provide guidelines for submitted electronic data.

- **Georgia Construction Details and Standards latest versions** –
<http://mydocs.dot.ga.gov/info/gdotpubs/ConstructionStandardsAndDetails/>

Provided above is a link to all GDOT Construction Standards and Details. Particular attention should be placed on commonly used standards and details for temporary barrier, impact attenuators, and detours (i.e. GA. STD's 4960, 4961, 4962, 9108, 9109, 9110, G-13, T-21, T-22).

- **Plan Development Process (PDP) latest version** –
<http://www.dot.ga.gov/PartnerSmart/DesignManuals/PDP/PDP.pdf>

This document must be referenced related to staging plans. Use the key word “staging” to search the document. Key PDP sections are shown below:

- Concept - checklist
- Preliminary Plans PFPR checklist
- Constructability Review checklist
- Final Plans
 - FFPR checklist
 - Final plans submission checklist
- Environmental Permitting (i.e. 404, stream variance, etc.) - must be taken into consideration in the development of staging plans.
- Environmental Document – all special conditions must be taken into consideration in the development of staging plans.
- **Supplemental Specifications** – <http://www.dot.ga.gov/PS/Business/Source>

The word “staging” can be used when searching–“State of Georgia Supplemental Specifications Modifying the 2013 Standard Specifications Construction of

Transportation Systems 2016 Edition' to review and account for requirements found in the GDOT supplemental specifications in the staging plans.

- **AASHTO Roadside Design Guide, Current edition** – reference tables and formulas for clear zone and barrier suggested for use in stage construction.
- **Transportation Management Plan (TMP)** – Included in GDOT policy and procedure 5240-1 titled Work Zone Safety and Mobility Policy
- **Project Specific Soil Survey** – should be referenced to determine allowable soils, slopes, and other geotechnical issues to be considered in staging plans.
- Requirements in the WFI and BFI if applicable.

12.2 Project Types

12.2.1. General

As a general guideline, most project types will require verification of constructability under traffic through staging plans. The guidance in this section can be used to evaluate the scope and major aspects of those plans. Final decisions should be based on a project's design and site conditions.

For each project type listed, common staging scenarios have been identified. These scenarios include a brief introduction to basic decisions relating to full depth pavement vs leveling, horizontal/vertical alignment changes, existing roadway typical section, and existing/proposed drainage. The listed design parameters should help in deciding to what extent staging plans are necessary.

12.2.2. When are Staging Plans Normally Required?

The following project categories are common types of projects where staging plans are normally required. The staging plans are necessary to identify and confirm that the proposed design is constructible while maintaining traffic on-site. This list is not intended to be an exhaustive list but representative of common project types.

- *Bridge/Culvert replacement* – Projects where a bridge or bridge culvert is being replaced while maintaining traffic on the current route or an on-site constructed detour will need staging plans. The construction of the bridge and roadway approaches will need to be staged to shift the existing traffic while allowing the existing bridge to be replaced. Likewise, culvert projects including box culverts and large pipes that require shifting of traffic during construction will require staging plans. (See DPM **Section 12.4.2 Drainage**)
- *New alignment* – New location roadways often require staging plans due to disruption of traffic during construction at the begin/end project tie-in locations with the existing roadway and/or existing crossroads. Typically, these staging plans are needed when significant grade changes or full depth pavement is proposed at the crossroads or tie-ins and cannot be accommodated with asphalt leveling nor be constructed under traffic. (See DPM **Section 12.4.4.2 Leveling**)
- *Widening* – Widening projects involve staging plans when traffic shifting is required during construction. Impacts to existing travel lanes can occur during these projects due to minimal construction clearances adjacent to the existing edge of pavement. Some widening projects also involve redesigning horizontal and vertical alignments for the existing roadway.

Consideration should be given as to whether shifting traffic is required during construction. If so, staging plans are needed. Additionally, these types of projects sometimes include drainage structures that require staging to maintain traffic. (See DPM **Section 12.4.2 Drainage**)

- *Intersections* – Intersections with vertical profile grade changes requiring full depth pavement in lieu of leveling need staging plans. Roundabout intersection projects typically need staging plans to verify constructability while shifting traffic. Additionally, the roadway approaches to intersections are commonly widened as part of these intersection projects and should be considered for staging.
- *Median Construction* – When shifting traffic is essential for constructing the median, staging plans are required. Median construction often includes widening as a design component. See above widening section.
- *Freeways/Interchanges* – freeway and interchange projects typically contain several design components requiring shifting traffic during construction. These projects often include bridge replacement, widening, intersections, medians, and sometimes new alignment. Refer to each project types above for guidance and see DPM **Section 12.4 Design Considerations**.

12.2.3. When are Staging Plans Normally Not Needed?

Existing traffic is not anticipated to be impacted during the construction of the following types of projects; however, DPM **Section 12.4 Design Considerations** should be considered when determining if staging plans are required. In addition, the district construction office can verify the need for staging plans for each project.

- Sidewalk / trail projects
- Standalone turn lane addition projects
- Signal improvements
- Preventative maintenance projects
- Signing / marking projects
- Guardrail / shoulder improvement projects
- Bridge construction (where traffic will be detoured offsite – detour plans required).

12.3. Plan Development Requirements

The Department's goal is to produce consistent, clear, and concise set of construction staging plans as the plans are being developed and ultimately finalized. This consistency helps to reduce costs, and errors and omissions in plan interpretations.

12.3.1. Concept Report

Early in the conceptual development of the project, the designer must determine if staging will be required to construct the project. Many factors influence the need for staged construction and these are to be addressed in the project concept report, which can affect the conceptual construction cost estimate. Factors to be considered in assessing staging include but are not limited to:

- *Availability of off-site detour state routes and condition of those state routes.*
 - Are there load-rated bridges and/or low-clearance overpasses along the route that would inhibit truck movement?
 - Will upgrades be required to pavement, sight distances, intersections, signals, guardrail, etc. to utilize the detour and have these costs been assessed?
- *Constructability of on-site staging:*
 - Can all existing travel lanes be maintained without the need for temporary pavement?
 - Will significant grade changes be required?
 - Will temporary signals be required?
 - Will potential utility relocations/phasing affect schedule and/or constructability?
- *Mobility issues:*
 - Is the project on school bus or public transportation routes that require maintained mobility?
 - Are there other forms of transportation that should be considered such as pedestrians, bicyclists and transit riders?
 - Is emergency vehicle mobility required to be maintained?
- *Environmental issues:* Have staging impacts to historical properties, communities, businesses, streams, wetlands, etc. been considered that affect environmental commitments and permits? *Project Construction Schedule:*
 - How many stages are required to construct the project?
 - How long will construction last?
 - Can an off-site detour be utilized to reduce the time of construction?
- *Project Footprint:* Will temporary alignments, on-site detours, or traffic shifts increase or lengthen the footprint?
- *Conceptual Construction Cost:*
 - Temporary pavement
 - Temporary drainage
 - Temporary signals
 - Temporary detour bridge
 - Erosion Control
 - Earthwork

The above items should be quantified to some level of detail and associated cost assigned so the designer can account for the staging related cost in the Conceptual Construction Cost Estimate.

- *Conceptual Right-of-Way Cost:* Is additional right-of-way or easement required to stage the project?
- *Conceptual Utility Cost:* Will temporary alignments during stage construction increase the utility relocation costs?

These cost estimates, which are part of the final Concept Report, are important so the Department can determine how to allocate project costs in their Work Program. The factors mentioned above

play an important role in developing a staging approach during the concept phase and eventually proceeding onto the preliminary plan phase.

12.3.2 Preliminary Plans

When construction staging plans are required (see Section 12.2.2 above) the following sections provide an overview of the different plan components that may be required. All portions of the plans should be developed in accordance with the Department's EDG and PPG.

12.3.2.1. Plan Drawings

The staging plan sheets are the primary tool to depict where vehicular traffic will be routed, or maintained, within the construction workzone while portions of the project are being constructed. When developing the staging plan sheets the following should be considered:

- Plan sheets should be developed for every construction stage of the project and should cover all locations where details are necessary to show routing or maintenance of traffic around the work zone. For the purposes of this Chapter, a Construction Stage consists of all the construction activities that must occur prior to any major traffic shift. The proposed work shown should correspond to the written narrative describing the work to be completed.

For complex projects, sub-stages may be utilized to further clarify construction sequence. For example, projects that require replacement of a box culvert may require additional construction stages for installation of temporary pavement or additional traffic shifts that are not applicable to the rest of the construction elements along the project corridor. When sub-stages are utilized, plan sheets for the sub-stages are only required to cover that portion of the project for which they are needed, and should include all lane tapers necessary for that particular sub-stage.

- Alignments, including curve data and/or taper rates, should be provided for all temporary/detour alignments necessary for shifting of traffic around the work zone. Temporary alignments are typically needed for median cross-overs and on-site detours (e.g. bridge replacements), although other conditions may require their use.

Ensure the temporary alignment is designed to the appropriate design speed for the temporary condition. Design speeds for temporary alignments may be reduced from the proposed final design speed utilized for the roadway. The design speed for temporary elements depends on road characteristics, functional classification, existing posted speed limits, highway capacity, existing traffic volumes, and percentage of trucks. Further reduction of speed during construction can be coordinated with District Traffic Operations. If a temporary speed reduction is utilized for some stages or the entire duration of construction, this should be noted on the plans and coordinated with Project Specific Special Provision 150.6 TRAFFIC CONTROL. Any reduction greater than 10 mph from the current posted speed limit requires approval from the State Construction Engineer.

- All intersections with public roads should show how traffic will be maintained. Particular attention should be paid where grade changes at intersections are required (on both the mainline and the intersecting road). Temporary or permanent re-alignments may be necessary in order to keep an intersection functional during construction and should be reflected appropriately in the staging plans.

Complex or major driveway intersections should be treated like a public road intersection regarding the level of detail required. In addition, driveways with greater than 10% grades are paved with concrete and are required to be stage constructed. Minor driveway intersections should be considered in the overall staging scheme, but do not require the level of detail that public road intersections require. The determination of the level of detail required at a specific driveway should be based on engineering judgement, however in general, complex or major driveway are those that are signalized or include dedicated left and right turn lanes and generally serve a commercial development. All other driveways will generally fall in the category of minor. For the staging of minor driveway intersections, the contractor is normally allowed to temporarily place traffic on stone (which is paid for as Aggregate Surface Course)

- A narrative of the sequence of construction on the first sheet of each stage or a stand-alone staging sequence narrative sheet that covers all stages if the narrative will not fit legibly on the first sheet of each stage. Additional notes may be added to sheets for site-specific activity as required. The sequence of construction should be a step-by-step method to coordinate the construction and maintenance of traffic to the contractor and should be reflected on the plans sheets in accordance with GDOT's Plan Presentation Guide.

At a minimum, the narrative should include reference to the placement of advanced warning signs, installation of traffic barrier, lane shifts/narrowing, shoulder closures, speed reductions, and construction of proposed elements or temporary elements needed for that stage or a future stage. Note: advanced warning signs are not required to be shown on the construction staging plans; the advanced warning signs will be included in the Contractor's Traffic Control Plan submittal.

- The Staging plans should delineate the traffic patterns on existing, or recently constructed proposed sections of pavement, during each stage of construction, using directional arrows and edge of travel lane lines, ensuring there is suitable room to maintain the required number of lanes during each stage. Temporary pavement will be delineated, as necessary, to facilitate traffic and should be shown in the plans. Temporary pavement construction should be shown as being installed in the stage prior to when traffic will be placed on it. A typical section is required to show pavement depths and lane widths to provide sufficient detail for construction and can be included in the staging plans section of the project or in the typical sections portions of the plans. Permanent work constructed in a previous stage, should be shown screened back so as not to conflict with the proposed/permanent work to be constructed in current stage.
- The Staging plans should show temporary positive barriers, as necessary, in accordance with AASHTO's Roadside Design Guide. This could include temporary concrete barriers, guardrail, and terminals / attenuators. Construction Drums (i.e. Barrels) or delineators (which are not considered positive barrier) are covered by Special Provision Section 150 and do not need to be shown in the plans.
- The Staging plans should include any temporary drainage including pipes, drop inlets, partially constructed permanent drainage structures, diversion channels or ditches, and culverts as necessary to ensure the removal of stormwater from the construction zone. Particular attention should be paid to the areas between the work zone and the travel lanes

where traffic shifts from one side of the road to the other to ensure stormwater runoff is not ponding, and that all stormwater is conveyed through the project.

- The plans should show grading limits per each stage of construction. If temporary slopes are used, these limits should be reflected in the plans for that stage. Ensure grading limits are not shown encroaching onto travel lanes carrying traffic or outside of the right-of-way and easements.
- Temporary Pavement markings for edge lines and directional lines should be shown for all stages of traffic, particularly if there is a traffic shift involved. Traffic shifts should be designed in accordance with GDOT Standards and Details and/or the MUTCD, most current edition. Limits of temporary detours, traffic shifts, and any other portion of the staging plan should be included in the overall project limits established and cleared under the environmental document for the project.
- Lane widths may be reduced during construction based on roadway classification, Traffic ADT and Percent Trucks. The designer should refer to AASHTO's Policy on Geometric Design of Highways and Streets (referred to as the Green Book) and the GDOT DPM for guidance related to temporary lane widths. Lane widths of 11-ft wide are preferred and lane widths less than 10-ft wide require further coordination with GDOT and approval by the District Construction Engineer, unless the existing or proposed lanes are less than 10-ft wide.
- Shoring should be delineated on the staging plan sheet when required. Shoring is the process of temporarily supporting earthwork during construction. For example, shoring could be needed when there is a large grade change between the proposed construction and the existing travel lanes. In most cases, shoring locations are shown on the staging plan and quantified for estimation purposes only, incidental to the Traffic Control or Grading Complete lump sum bid items, but is designed by the contractor. Coordination with the District Construction Office should be performed to determine how shoring is ultimately quantified and paid for.
- Staging profiles are utilized to control the grade of temporary roadways, such as on-site detours and median crossovers. When developing the construction staging plans, ensure the staging profile is designed to the appropriate design speed for the temporary alignment.

12.3.2.2. Cross-sections and Typical Sections

The staging cross-sections are utilized to develop earthwork by construction stage and to ensure traffic can be adequately staged, particularly where significant grade changes are required. When developing the staging cross-sections, the following should be considered:

- Staging cross sections should be included in the plans when mass grading operations will occur over multiple stages. Projects where all earthwork occurs in one stage, a simple widening project for example, may not need to include staging cross-sections.
- Staging cross-sections should be designed to utilize as much of the permanent construction as possible to minimize the need to construct "throw-away" work. Development of the final design should consider the construction staging requirements so that the best overall project is achieved. For example, the designer may need to consider whether utilizing temporary pavement or shifting the permanent alignment would be more beneficial to the overall project.

- Staging cross-sections should only include dimensioning for the current stage of construction. Combining multiple stages of cross-sections on one sheet can lead to confusion during construction operations. Work that has been completed in a previous stage should be shown and screened back with no dimensioning. Grading limits should tie to existing ground or to work constructed in a previous stage, if applicable. Care should be taken when preparing earthwork quantities by stage to ensure earthwork is not double counted.
- Staging cross-sections should illustrate all required grading, temporary and permanent drainage (ditches, curb & gutter, etc.), traffic barriers, shoring, and lane configuration during that stage.
- For projects with multiple alignments/roadways, (e.g. an interchange construction project), staging cross-sections may not be required for all alignments and normally only need to be included for those alignments that meet the conditions above.
- Frequency of cross-sections and/or typical sections will depend on the complexity of the staging. If the staging conditions are relatively consistent over a long distance, a typical section and/or cross sections at 100 to 200-foot intervals might be warranted. If there are lane shifts, shoring, and/or temporary drainage changes, staging cross sections at 50-foot intervals should be provided. Directional arrows should be included showing the location and direction of traffic.

12.3.2.3. Coordination with Other Plan Sections

The construction staging scheme for a given project can have impacts that affect other areas of the plan development process. The Erosion, Sedimentation, and Pollution Control Plans (ESPCP) are developed per the construction staging plans for the project. It is paramount that these sections of the plans are developed in conjunction with each other. Any changes or revisions that are required to the staging plans should be carried through the ESPCP, and any other portion of the plans that are affected.

During development of the staging plans, any temporary detour alignments and profiles, temporary pavement construction, temporary drainage requirements, and other items that may be required should be coordinated with the Right-of-Way plans for the project to ensure appropriate right-of-way and/or easements are acquired to construct the project. Due to the length of time it takes to acquire right-of-way and easements for a project, these items should be established as early in the development of the staging plans as possible. Revisions to the staging plans during final plans in order to make a project constructible that will affect property acquisitions can have a considerable effect on the project schedule.

Utilities can often be overlooked when developing the staging plans for a project. Regular communication with the Utility Coordination Team (State Utility Office, District Utilities, SUE Team, etc.) is critical to ensure the existing utility infrastructure is included for the limits of all temporary and permanent work and that any relocations due to temporary work required to build the project has been properly coordinated with the utility facility owner. In addition, the project staging plans should be coordinated with the utility relocation schedules to allow for early construction of stages where utility relocations are not required.

12.3.2.4. Project Specific Special Provisions

There are certain project specific special provisions that need to be developed by the design team, in coordination with the Office of Construction. The GDOT PDP should be referred to for identification of individuals responsible for drafting project specific special provisions. The following special provisions will be drafted by the District Construction Engineer, with input from the design phase leader and will be based on the constructability review and/or the final staging plan for the project:

- Project Specific Special Provision 150.6 TRAFFIC CONTROL – This project specific special provision provides restrictions the contractor must adhere to when performing the work including, but not limited to:
 - Minimum number of lanes to be maintained
 - Lane closure restrictions (days/hours allowable)
 - Reduction of speed limit

Designers should ensure that the staging plan developed for the project can be constructed in accordance with the requirements specified in this special provision.

- Project Specific Special Provision 108.08 PROSECUTION AND PROGRESS – This project specific special provision sets forth intermediate completion milestones. In addition, this specification also sets forth contract deduction amounts for failure to open portions of the work or re-open lanes outside of the allowed lane closure period. Designers should ensure that the staging plans developed for the project will adequately allow for completion of the project and coincides with any intermediate completion milestones.

12.3.2.5. Quantities

Development of the construction staging plans will assist in the identification of additional pay items or additional quantities for current pay items that should be included in the letting proposal. There are two methods of paying for items required due to the staging of the project; they are either included in a lump sum pay item, such as traffic control or grading complete, or they are included as separate pay items in the bid set. These include, but are not limited to the following:

- Work zone law enforcement
- Temporary drainage items
- Temporary signals
- Temporary barrier/attenuators
- Variable message signs recommended by District Construction
- Temporary shoring (shoring is not always incidental to the cost of grading complete).
- Temporary pavement markings (not normally quantified, only when specified by the District Construction Office)

The designer can coordinate with the District Construction Office to determine how these items are to be quantified and paid for in the plans. If these items are to be paid for under Traffic Control lump sum and/or Grading Complete (or other lump sum items), then notes must be added to the plans accordingly.

12.4 Design Considerations

12.4.1. Earthwork

The staging plan should consider the amount of earthwork being moved within each stage of construction in order to balance each stage as practical. Further, the overall staging of the project should consider the amount of excavation and borrow occurring in subsequent stages to minimize the amount of off-site hauling required. Borrow being hauled onto a project site in an early stage only to have excavated fill be hauled off the site in a later stage does not efficiently utilize the amount of earthwork available within the project limits.

Staging cross-sections and earthwork design should also identify potential areas where steeper slopes and shoring (See section 12.3.2.1 of this chapter) may be temporarily required to avoid property and environmental impacts or to facilitate maintenance of traffic. Steep slopes should follow the maximum identified in the projects soil survey summary, unless approval is received from OMAT for the use of steeper slopes.

Proposed slopes that are non-recoverable or require shoring should meet clear zone requirements for the speed design of the staging plan and the ADT projected to be present during construction. Temporary barrier should be provided where clear zone is not established for proposed slopes. Existing slopes should also be evaluated for meeting clear zone when traffic is shifted closer to existing slopes, potentially reducing the clear zone.

12.4.2. Drainage

Drainage is an important consideration during the construction of a project. The contractor will be required to maintain positive drainage throughout construction. An adequate staging plan will help to identify potential locations for temporary drainage structures and pipes. Depending on the depth of storm drain pipes, the engineer may also recommend if the pipe is to be installed by an open trench or require a jack and bore. These drainage features and construction approaches can significantly impact the cost of a project. Temporary drainage items required for stage construction should be quantified separately and provided in addition to the overall drainage quantities for the project. Drainage structures and/or pipes that are installed for permanent construction and shown in the staging plans to facilitate stage construction are not paid for separately, but are incidental to the permanent drainage bid items.

The staging plan should provide recommendations for pipes and structures that are to be capped during construction. This may be necessary when storm drain systems cannot be fully installed during a single stage of construction. The temporary end of the storm drain line can be temporarily capped for future stages. The engineer should ensure that existing or proposed storm drain systems will function adequately during each stage.

The decision to jack and bore a storm drain pipe may be determined after evaluating the depth of the proposed pipes and utilities or other obstacles that may be in conflict with an open trench. Jack and bore operations also require bore pits and accessibility to the pipe elevation on both sides of the embankment, which may require additional right of way or easements and excavation. Common practice is to avoid open cut of pipe installation under existing traffic on an Interstate or Freeway. Payment for the jack and bore should be included in addition to the storm drain quantities (See Standard Specification 615).

Existing storm drain pipes and structures that are not to be used after completion of the project will be removed or abandoned in place. Storm drain pipes are normally abandoned in place due to the potential impacts to traffic or other features being maintained and cost of excavating and removing them. These impacts may include additional maintenance of traffic issues, property impacts, excavating roadway pavement, curb and gutter or sidewalk that could otherwise be maintained. Flowable fill will be used on flexible pipes and concrete pipes greater than 24-in that are being abandoned to avoid future collapse of these pipes. Concrete pipes (24-in and below) proposed to be abandoned will be capped. They are required to be in good condition. They must be free of cracks and have not shown signs of joint separation, etc. The proposed height of fill must also not exceed the concrete classification of pipe; otherwise, flowable fill will be used.

When designing temporary drainage for staging, the GDOT Drainage Manual allows some flexibility in design criteria for temporary detours and temporary culverts.

12.4.3. Erosion and Sediment Control

The intermediate stage erosion control plans should mimic the staging sequence of the project. BMPs should be designed to capture sediment for each independent stage. This may result in BMPs needing to be removed and replaced in between stages due to changes in grade or drainage patterns. Erosion control plans should reflect all temporary BMPs in the stage that they are to be utilized.

12.4.4. Pavement

Chapter 10 of the DPM provides guidance for the pavement design process and areas of design and construction plan production related to pavement design. The Pavement Design Manual provides pavement design guidelines and policies. Once proposed pavement sections are established, consideration must be given to how the pavement will be constructed, often while maintaining traffic throughout the construction area. Full-depth pavement replacement, profile grade changes, and proposed concrete pavement areas each offer construction challenges that must be planned for as part of construction staging and maintenance of traffic. If the project includes alternate pavement sections, the constructability of the alternate section should also be considered.

12.4.4.1. Pavement Types

Construction staging must consider the type of pavement to be constructed. Construction processes, techniques and other factors like cure times differ significantly between asphalt pavement and concrete pavement. Both asphalt and concrete pavement sections are used throughout Georgia, and the benefits in specific applications should be vetted through the Pavement Type Selection process. Generally, asphalt pavement construction is more conducive to maintenance of traffic, but this benefit can be outweighed by the durability benefits gained with concrete pavement. This is especially true in areas where high truck volumes are anticipated. In addition to cure times, other parameters such as joint locations, dimensions, geometry, and reinforcement requirements must also be considered in concrete pavement construction.

12.4.4.2. Leveling

Asphaltic concrete leveling is frequently used to adjust cross slopes, affect temporary tie-ins, and make grade adjustments. For depths greater than one foot, full-depth replacement should be considered, as it is typically a more cost-effective alternative. There are cases in which leveling depths

greater than one foot are necessary and acceptable, and these cases should be coordinated with the District Construction Engineer.

12.4.4.3. Temporary pavement

Temporary pavement sections should be designed in accordance with Chapter 10 of the Design Policy Manual guidance and the Pavement Design Manual. Construction staging plans should illustrate on-site detour and temporary pavement areas with sufficient construction details such as dimensions, taper labels, temporary alignments and profiles, etc. Detour and temporary pavement sections should be illustrated in the project Typical Sections.

12.4.4.4. Shoulders

Existing paved shoulders are sometimes used to maintain traffic during construction staging. In these cases, the existing pavement section should be evaluated (by corings, coordination with the local Area Office, and/or review of existing plans) to confirm that the existing pavement structure meets the required design load. If not, consideration should be given to enhancing or replacing the paved shoulder. In cases where proposed paved shoulders are used to stage traffic, the design load may dictate a more substantial pavement structure than normally required for a paved shoulder (see section 10.8.2). On-site detours must be coordinated with the Office of Construction during the Constructability Review and addressed in all applicable Specifications and Special Provisions.

The cross slope of paved shoulders should also be evaluated and corrected where necessary before staging traffic on the paved shoulders. All shoulder closures of any type or duration must be coordinated with the Office of Construction during the Constructability Review (see Special Provision 150.3.05). Long, uninterrupted shoulder closures should be avoided on interstates and freeways. Where both inside and outside shoulder closures are required, special attention should be given to Special Provision 150.3.01.D. which dictates restrictions regarding simultaneous shoulder closures.

12.4.5. Temporary Concrete Barriers and End Treatments

Temporary concrete barriers and appropriate end treatments should be included in the construction staging plans and cross sections where required. Barrier layout and end treatments should be designed in accordance with the AASHTO Roadside Design Guide, DPM Section 5.4, all applicable Construction Standards and Details, Specifications, and Special Provisions including but not limited to Section 150.1, Section 620, STD 4960, STD 4961, and STD 4962. The construction staging plans should also designate all appropriate barrier end treatments, impact attenuators, and temporary barrier Method in accordance with the Standard Specifications.

STD 4960 details five barrier end treatment options:

1. Tapered Approach
2. Tapered Approach with Temporary Guardrail Anchor
3. Portable Attenuator
4. Cast-in-Place Temporary Barrier Transition
5. Guardrail Connection

When selecting the appropriate end treatment, designers should consider the working width and deflection width of roadside safety hardware. These should also be considered when selecting the appropriate barrier installation Method (see DPM Section 5.4.1).

12.4.6. Traffic Control

12.4.6.1. Temporary Traffic Signals

Construction staging in urban areas often requires temporary signal head adjustments and phased implementation of new, permanent traffic signals. Shifting signal heads on existing or newly constructed span wire is incidental to the cost of Traffic Control and is not typically detailed on construction staging plans. In some instances, however, temporary traffic signal installations are often necessary to implement on-site detours, temporarily shift and/or change the elevation of an intersection, temporary single-lane closures, or accommodate other unique construction staging requirements. The design of temporary traffic signals should be coordinated with the Office of Traffic Operations.

12.4.6.2. Signing and Marking

Pavement markings for construction staging plans are typically limited to lane lines and turn arrows. Traffic flow arrows are also included in staging plans to indicate active traffic lanes, but these are not intended to be actual pavement markings. Where construction staging is required, consideration should be given to the type of striping required in each stage (i.e. paint or thermoplastic) and how temporary striping will be removed or eradicated. A common approach with asphalt paving is to place the surface course in the final stage of construction, and final pavement markings are installed on a clean asphalt surface. Alternative methods of eradication include water blasting and grinding, but neither method is effective in completely removing markings without “ghosting”. “Ghosting” may result in driver confusion in low-light areas.

Temporary construction signs are included in Traffic Control specifications and details and are not typically shown on the construction staging plans. Where off-site detours are required, however, a Detour Plan should be included with detour signage designed and detailed in accordance with the MUTCD.

12.4.6.3. Closures

Multiple types of closures may be required to stage the construction of a project and maintain traffic. The two types most frequently utilized are temporary road closures and temporary single-lane and multi-lane closures. Full closures typically require off-site detours, which must be planned, coordinated and developed in accordance with the PDP and detailed in plans Section 20. Single-lane and multi-lane closures are typically left to the discretion of the contractor and the Department’s Construction Project Engineer. The contractor is required to develop and operate the closure in accordance with the Department’s Standards, Specifications, and Special Provisions and in accordance with the MUTCD. Single-lane and multi-lane closures may be referenced in the construction sequencing notes, but they are typically not otherwise documented in the construction staging plans. All restrictions regarding single-lane and multi-lane closures must be coordinated with the Office of Construction and documented in the Project Specific Special Provisions 150.6 and 108.08 along with penalties for violating the restrictions. Project Specific Special Provisions 150.6 and 108.08 must be submitted to the State Construction Office for Approval when requesting FFPR (refer to submittal process and requirements established by State Construction Office).

A milling and resurfacing operation on a two-lane roadway is an example of a single-lane closure construction operation that would not be documented in the construction staging plans. In this operation, the contractor will close a section of one lane while using a pilot car and flaggers to

alternate the traffic flow direction of the second lane. This type of operation progresses linearly along the roadway in one direction to a certain point at which the contractor will move the operation to another lane. In most instances, the contractor will reopen all lanes to traffic overnight and during peak hours.

12.4.6.4. Off-site Detours

As noted above, full closures typically require off-site detours, which must be planned, coordinated and developed in accordance with the PDP, and detailed in plans Section 20. When detouring a State Route, the detour route should include only other State Routes unless an agreement is in place with a local municipality to include specific, off-system routes. Such an agreement might include requirements to complete a pavement evaluation for the off-system route, pavement and shoulder enhancements, and other safety-related improvements. The net length of a detour route should be determined and reviewed for feasibility. For example, if the distance between Town A and Town B is 18 miles via the route to be closed and the distance via the detour route is 25 miles, the net length of detour is 7 miles. A Road User's Costs study may be a useful evaluation tool for detours with severe anticipated impacts. A Detour Report and a Notice of Detour Approval will be required for all projects utilizing an off-site detour, see PDP Appendix I. The plans should clearly indicate whether the installation and maintenance of the detour will be the responsibility of the Contractor or GDOT.

12.4.6.5. Traffic Shifts - Speed Drops

In accordance with Special Provision 150, speed limit drops through a Highway Work Zone are limited to a maximum of 10 MPH below the posted speed limit except where the existing speed limit is 60 MPH. Where the existing speed limit is 60 MPH, the drop is limited to 5 MPH. Any required deviations from this must be coordinated with the Office of Construction. All construction staging components, such as detour alignments, traffic shifts, median crossovers, and lane tapers should be designed to meet the design parameters of the construction zone Speed Limit.

Chapter 6 of the MUTCD is dedicated to Temporary Traffic Control, and it should be used as a design guide for construction staging components. In Chapter 6, the MUTCD describes five types of tapers for temporary work zones:

1. Merging Taper
2. Shifting Taper
3. Shoulder Taper
4. One-Lane, Two-Way Traffic Taper
5. Downstream Taper

The MUTCD and Special Provision 150 offer guidance on each type of taper for various construction zone speed limits.

12.4.6.6. Side roads and Driveways

Sideroad construction staging must be considered by the Design Phase Leader. If the project complexity dictates the need for construction staging plans and cross sections at a particular intersection, sideroad staging plans should also be included. This is especially true where horizontal and vertical changes are proposed and even more so at intersections.

Access to public access points, businesses, and residences must be maintained during construction, and staged construction should consider temporary access. It is not practical, however, to detail every

temporary access scenario in the construction staging plans. The Design Phase Leader must consider this requirement and review the design to ensure that the design and construction sequence does not preclude this requirement. The Design Phase Leader should consider including critical access provisions, such as temporary, common access points on urban widening projects. At a minimum, access should be maintained with aggregate surface course for low volume access points.

12.4.6.7 Alternative Modes of Transportation

12.4.6.7.1 Pedestrians

Temporary pedestrian accommodations and routing through construction zones will be maintained where existing pedestrian accommodations are present and utilized (see Special Provision 150.1.04.C). For example, in an urban, downtown area where pedestrian volumes are heavy throughout the day, a sidewalk closure and pedestrian detour is necessary. This may be as simple as closing the affected sidewalk one block before the construction area and crossing traffic to pedestrian accommodations on the opposite side via an existing crosswalk. As another example, a rural bridge location would normally not serve a significant number of pedestrians, and a pedestrian detour plan would not be practical.

Both examples above are straightforward, and practical design solutions are apparent. In the middle of the spectrum, however, a project may propose a sidewalk where a worn footpath is present in an area with no existing pedestrian accommodations and limited right of way. In this case, the project is addressing a need for pedestrian accommodations, but a temporary pedestrian plan may not be practical. In all cases, maintaining work zone safety for corridor users and construction workers with practical design solutions is the overarching objective.

12.4.6.7.2 Bicycles

Like pedestrian accommodations, temporary bicycle accommodations and routing through construction zones should be considered where existing accommodations are present. Existing bike lanes adjacent to traditional traffic lanes should be detoured and maintained along with the other vehicular lanes. Impacts to other designated bicycle facilities or trails must also be considered. An example might be a project that crosses a facility like the Silver Comet Trail. In this case, construction staging should address bicycle and pedestrian traffic needs and accommodate these modes efficiently.

In general, Design Phase Leaders should note designated bike routes, both State and local, during design, and maintain existing accommodations in construction staging plans. Here again, maintaining work zone safety for corridor users and construction workers with practical design solutions is the overarching objective.

12.4.7. Utilities

Location of existing utility facilities, both those being retained and those to be in operation during construction activities, must be considered. Coordination with utility owners during the concept phase and through the design process is critical to understanding potential design constraints and staging considerations.

Maintaining operation of overhead facilities during construction activities will require certain clearances from construction equipment and proposed design features, as directed by the utility owner. The designer should request these horizontal and vertical clearances from all utility owners

within the project limits during the first utility submittal, as these clearances might vary by utility owner requirements and/or facility characteristics.

Clearances with utilities should be understood as early in the design process as possible. The designer should understand what facilities will be retained and what facilities will be relocated and where. In addition, the designer needs to understand whether any existing facilities can be shut down or bypassed during construction. This may change seasonally and should be addressed in the plans and/or special provisions. Another instance is sound walls, overhead sign structures or MSE walls and overhead clearances.

12.4.8. Structures

12.4.8.1. Utility Clearances

Clearances/offsets from existing utility facilities may dictate the ability to use cranes, hammers, beam launchers, etc. and therefore affect the construction cost and/or right-of-way needed. This is especially important for the installation of bridges; retaining walls; sound walls; overhead sign structures; and signal, ITS, and/or lighting equipment. For example, overhead transmission lines typically require a cylindrical radius of clearance from the lowest point of the lowest hanging line. Maintenance of utilities may also affect the location of the proposed bridge, especially when constructed adjacent to an existing bridge structure. Underground facilities intended to be installed on the outside of the bridge or within the bays could be limited by beam size or even dictate the beam size.

12.4.8.2. Staged Construction

The decision to utilize existing bridge structures for staging must consider the condition of the existing bridge. Structural deficiency could preclude the installation of additional dead loads, such as temporary concrete barrier. Where traffic is to be maintained on an existing bridge, cut lines for the removal of a portion of the existing bridge must be done with respect to the existing beam locations, which will dictate the width available for maintaining staged construction.

When a proposed bridge is constructed in phases and traffic is proposed on a partially constructed segment, the designer must detail how the traffic will be maintained, including providing adequate lane widths and barrier offsets. Where concrete barrier is proposed, the designer must confirm with the Office of Bridge Design and Maintenance if anchoring to the new bridge deck is acceptable. If not, a minimum of 6-feet must be provided from the center of the temporary barrier to the edge of the bridge (See Standard Specification 621). A minimum of 5 feet of working space between an existing bridge and a proposed bridge must be provided at all times to allow for construction activities. In addition, the designer should consider impacts to existing bridge wingwalls where adjacent construction, temporary or permanent, is proposed. To avoid overbuilding of bridges, the designer should make full use of the proposed bridge deck during construction. For example, where a sidewalk or trail is proposed on a bridge, staged traffic may utilize a portion of the future sidewalk/trail prior to its installation.

The installation of walls may also dictate adjustments to traffic patterns. For example, where an MSE Wall is proposed adjacent to an existing roadway, the contractor must be provided with adequate area to install the straps and be able to grade back the temporary slope (or provide shoring). This may require lane closures, temporary pavement, etc. to accommodate. With any wall installation, the design plans should account for temporary grading required during construction activities. These

grading limits may affect right-of-way and/or easement needs, erosion control, temporary drainage, etc.

12.4.8.3. Work bridges, work platforms, and temporary access roads (consistency with Section 20 Construction Staging Details)

The designer should account for these features in the design plans as well as for any permitting and/or environmental documentation purposes. Site access needs may also impede on utilities, railroad rights-of-way, and other adjacent properties. Adequate room for the movement of construction equipment and materials must be provided and even delineated in the design plans. Cofferdams and other project-specific needs may require detailing for construction, maintenance, and removal purposes. The designer should clearly note in the plans how temporary items needed for construction are to be paid for during the bidding process.

12.4.9. Post-construction BMP's/Water Quality Features

Post-construction BMP's can often serve a secondary purpose of providing temporary sediment storage during construction activities. Installation of post-construction BMP's need to be documented in the staging plans as well as shown in the appropriate stage of construction in the erosion, sedimentation, and pollution control plans, regardless of their use or non-use for temporary erosion control purposes. Adequate right-of-way or easement for maintenance drives, silt fencing, outlet features, etc. must be provided. Additionally, measures for prohibiting public access to ponds or other large BMP's; especially in populated areas or near schools, playgrounds, etc.; during construction activities should be noted in the staging plans.

12.4.10. Lighting

Staging plans would not be required for the installation of stand-alone lighting facilities where the lighting installation will not impact traffic patterns or where the lighting is being installed by a utility owner. However, where lighting design is included in the roadway design plans and these lighting facilities require construction in multiple stages or the lighting facilities installation will impact traffic patterns, these features should be accounted for in the staging plans. For example, bases and conduit may need to be installed earlier in the construction sequence and light fixtures and wiring in a latter phase. Staging plans should also account for any disturbance associated with trenching, including removal of existing curb and gutter and/or sidewalk. Conduit boring locations should be adequately sized for construction equipment.

12.4.11. Railroads

Projects that encroach on or adjacent to right-of-way owned by railroad companies will require extensive coordination throughout the project lifecycle, to include considerations for constructability. Plans and/or specifications must clearly communicate where construction equipment is or is not allowed adjacent to railroad tracks, provide contact information for railroad owners, provide for any temporary railroad equipment (including temporary signalization and/or gates), maintain existing access for railroad maintenance and operations personnel and equipment, and other considerations. As mentioned for other plan items, the plans should detail how temporary items needed for construction across or adjacent to railroad tracks are to be paid for. The designer should be aware of any pending improvements by the railroad owner that could affect construction design or activities. Temporary drainage should avoid tying to existing railroad drainage except where necessary or existing drainage patterns dictate.

12.4.12. Common Problems

While not intended to be an all-encompassing list, the following items have been identified as common problems found with staging plans:

- Cross sections do not match the typical sections and plans.
- Staging plans and cross sections do not include turn lanes during construction (Special Provision 150 states that there is no reduction in the total number of lanes including turning lanes that existed prior to construction).
- Staging cross sections do not match earthwork cross sections.
- Plans lack sufficient detail of temporary drainage.
- Staging of Driveway and sidestreet access is not adequately addressed.
- Pedestrian accommodations not accounted for in the staging plans, including activated crossings at signals, ADA-accessible facilities for alternatives, etc.
- Disconnect between the staging plans and the staging narrative.
- The plans do not consider concrete pavement construction joint placement as it relates to the permanent lane locations, such as incorrectly showing joints as being installed along wheel paths.
- Creating concrete pavement shapes that are susceptible to early failure. See Chapter 10 of this Manual for additional information.
- Plans do not adequately address retaining wall/side barrier installation needs, such as temporary grading, clearance for MSE wall straps, etc.
- The plans call for temporary slopes that do not match geotechnical recommendations or the geotechnical documentation does not provide guidance for temporary grading conditions.
- The plans do not adequately address the construction of medians and associated temporary traffic shifts. Existing medians are not being shown as removed and replaced.
- Temporary pavement design and/or typical section not provided in the plans.
- Staging cross sections do not adequately address consistent lane widths, shoulders, clearances and temporary barrier widths.
- Inappropriately using temporary concrete barrier as a means of retaining slopes during construction.
- Temporary end treatments, such as attenuators, either not shown in staging plans or inadequate room is provided to install the end treatment.
- Barriers/Attenuators result in inadequate sight distance at intersections or driveways.

12.5. Acknowledgements

This chapter was developed by the Georgia Partnership for Transportation Quality (GPTQ) Consultant Relations Committee - Subcommittee on Roadway Design Policy in coordination with the

GDOT Office of Design Policy and Support and the GDOT Office of Construction. The Division of Engineering acknowledges and appreciates the efforts of **Alex Stone of CALYX Engineers** for leading this effort and the following subcommittee members.

• Brad Cox	Clark Patterson Lee
• Kevin Ergle	Kimley Horn & Associates
• Brad Gowen	Holt Consulting Company
• Chris Marsengill	Moffatt & Nichol
• Tyler McIntosh	Infrastructure Consulting and Engineering
• Brad Robinson	Wolverton & Associates
• Bill Rountree	Parsons Corp.

The GDOT Division of Engineering also acknowledges and appreciates the efforts of the GDOT Roadway Design and Engineering Services for providing valuable comments on draft versions of this policy.

Chapter 13. Traffic Studies - Contents

- Chapter 13. Traffic Studies - Contents 13-i
- 13.1. Traffic Data 13-1
- 13.2. Traffic Projections 13-1
- 13.3. Trip Generation and Assignment for Traffic Impact Studies 13-1
 - 13.3.1. Trip Generation 13-1
 - 13.3.2. Traffic Assignment..... 13-4
- 13.4. Freeway Capacity and Design 13-5
 - 13.4.1. ITS Technology 13-5
 - 13.4.2. Capacity Analysis and Level of Service..... 13-5
 - 13.4.3. Ramps and Ramp Junctions 13-8
 - 13.4.4. Traffic Management Strategies 13-9
- 13.5. Arterial Capacity and Design 13-12
 - 13.5.1. Capacity Analysis and Level of Service (LOS) 13-12
 - 13.5.2. Traffic Analysis Procedures..... 13-12
 - 13.5.3. Intersection Traffic Control and Design 13-13

Chapter 13. Traffic Studies

13.1. Traffic Data

Chapter 4. Refer to the [GDOT Design Traffic Forecasting Manual](#).

13.2 Traffic Projections

Chapter 5. Refer to the [GDOT Design Traffic Forecasting Manual](#).

13.3. Trip Generation and Assignment for Traffic Impact Studies

Trip generation is the process used to estimate the amount of traffic associated with a specific land use or development. A manual estimate of trip generation from the development will be required for all analyses. Trip assignment involves placing trips generated by the new development onto specific roadways and adding them to specific turning movements at each area intersection.

13.3.1. Trip Generation

For the purposes of this manual, a trip is a single vehicular movement with either the origin or destination within the study site and one origin or destination external to the land use. Trip generation is estimated through the use of “trip rates” or equations that are dependent on some measure of intensity of development of a particular land use. Gross Leasable Area (GLA) is the most common measure, but there are other measures such as number of employees, number of parking spaces, or number of pump islands (as at a gasoline station) that are included as well.

The current [ITE Trip Generation Report](#) (Trip Generation) contains the most comprehensive collection of trip generation data available. The rates and equations provided in this handbook are based on nationwide data. Some rates or equations, especially newer land use categories, are supported with a limited number of studies. However, this manual is accepted as the industry standard. Therefore, the rates and equations from Trip Generation shall be applied. Deviation from rates, equations, or applications described in the Trip Generation must be discussed and approved by appropriate GDOT staff prior to use in any study.

Trip generation data includes:

- **Land Uses** - Each land use type within *Trip Generation* is identified with a unique numeric land use code. Similar land use types have code numbers that are close together. Some of the more common ITE land uses are listed in the **Table 3.2**.

Table 13.2. Common ITE Land Use Codes

ITE Land Use Code	Land Use Name
210	Single Family Detached Housing
220	Multifamily Housing (Low-Rise)
310	Hotel
520	Elementary School
565	Day Care Center
710	General Office Building
770	Business Park
814	Variety Store
820	Shopping Center
853	Convenience Market with Gasoline Pumps
912	Drive-in Bank
932	High Turnover (Sit-Down) Restaurant
934	Fast Food Restaurant with Drive-Through Window
Source: ITE. (2017). <i>Trip Generation</i> , 10 th Ed.	

- Primary Trips, Passer-By Trips, and Diverted Trips** The total trip generation volumes are typically computed as described previously and the generated trips are divided into these three components:

Primary trips are made for the specific purpose of visiting the development. Primary trips are new trips on the roadway network.

Passer-by trips are trips made as intermediate stops on the way from an origin to a primary destination. Passer-by trips are attracted from traffic already on adjacent roadways to the site.

Diverted trips are similar to passer-by trips except that they are attracted to a development from a nearby street or roadway that is not directly adjacent to the development. Like passer-by trips, diverted trips are not new to the roadway system overall. However, unlike passer-by trips, diverted trips use new routes to get to and from the development compared to their original route and thus have more impacts to the nearby roadway network than passer-by trips.

- Study Network** - The study network consists of the roadways in the vicinity of the development that traffic must use to enter and leave the study area. The study network includes the site access intersections onto adjacent off-site roadways and the sections of these off-site roadways that are located within the study area. The study network is further identified as a series of key intersections, which are the critical points and potential bottlenecks in urban and suburban roadway networks. Roadways within the study area can be further subdivided as described below.

- **Site Access Points** - These include key entrance roadways and driveways that serve the development and their intersections with the adjacent street and roadway network. These entrances/access points are usually newly constructed as part of the development.
- **Existing Roadway Network** - At a minimum, these are the streets and roadways that immediately adjoin the development. For larger developments, the network of streets and roadways to be included in the study can extend a considerable distance away from the immediate vicinity of the site. The key intersections along the roadways within the study area are the source of most delay and are what should be evaluated. The number and location of intersections that are to be included in the traffic impact study will be determined in consultation with GDOT prior to preparation of the study.
- **Roadway Improvements Proposed as Part of Development** - These include public streets and roadways that are proposed to be relocated, widened, or newly constructed as part of the proposed site development. The traffic assignment will take into account changes in traffic patterns caused by any proposed changes or additions to the roadway network.
- **Committed Offsite Roadway Improvements** - These include proposed roadway and intersection improvement projects that will be constructed by others within the time period of the study. The “others” are usually GDOT or local governments, but they could also include projects that will be constructed by other developers within the study area. Changes/improvements to roadways and intersections caused by these projects will be included in the traffic impact study. If it is uncertain whether or not a particular project will be completed, then alternative scenarios must be evaluated.

Land Uses Not Identified in the ITE Trip Generation Report

The vast majority of real estate developments can be identified or approximated with land uses identified within *Trip Generation*. However, the commercial and residential real estate markets are constantly evolving, and new land use types, especially commercial and retail, are created all the time. Since *Trip Generation* is updated on a periodic basic, new land use categories are already in widespread use before being incorporated into *Trip Generation*.

New types of “big-box” retail establishments are constantly being created that do not neatly fit in any single land use category included in *Trip Generation*. There are even new land use types that combine aspects of offices and warehouses and even retail. Large entertainment land uses such as casinos or theme parks may generate large numbers of trips, but are so specific as to not be covered by the more general land use categories included in *Trip Generation*.

For land uses that are not found within *Trip Generation*, trip generation volumes can be estimated using other available information. However trip generation is estimated, each assumption must be clearly stated with supporting information provided to the satisfaction of the reviewer. Permissible methods are listed below.

- Utilize available marketing studies prepared by the client/developer
- Patronage estimates for rail/bus stations by transit agency
- Available parking spaces and assumptions on parking turnover per peak hour

- Using an existing ITE land use that most closely resembles the new land use, and modifying or adjusting generated trips, with all assumptions/calculations clearly stated

13.3.2. Traffic Assignment

Traffic assignment is the process of placing site-generated trips onto the roadway network within the study area. Traffic assignment is done either manually or with modeling software. Traffic assignment for small- to medium-sized developments is more commonly handled with manual methods, while modeling software is often used for larger developments that have regional impact. The site-generated trips (usually vehicles per peak hour) are added to the “background” traffic, which usually consists of the existing peak hour turning movement volumes at each intersection plus additional turning movements which account for compounded annual growth and sometimes traffic attributed to other nearby developments. The combined site-generated and background traffic form the total assigned traffic (intersection turning movements) that is used to measure level of service and determine necessary roadway improvements which account for anticipated development.

Traffic Assignment for Phased Developments

Many large developments are constructed in several phases over a period of years. The traffic impact study can reflect this reality by analyzing one or more intermediate phases, plus the full build-out scenario. Each new phase will assign additional traffic onto the assumed roadway network for that year. Background traffic for each new phase must include traffic assigned from previously opened phases of development.

Traffic Assignment of Three Major Trip Types

The three major trip types are: (1) primary trips, (2) passer-by trips, and (3) diverted trips. Each trip type will be separated when assigning site-generated traffic throughout the study network. This makes it easier for the reviewer to follow the assignment process and identify errors.

Primary trips are made for the specific purpose of visiting the development and they are new trips on the roadway network. Traffic will be assigned for primary trips throughout the study network according to the trip distribution percentages to and from the study area.

Passer-by trips are trips made as intermediate stops on the way from an origin to a primary destination. Passer-by trips are attracted from traffic already on adjacent roadways to the site. These trips are separately assigned to the study network only at site-access intersections and on internal circulation roadways within the site development itself. Turning movement volumes will be added at these intersections for entering and exiting traffic, while the through movements will be reduced by an equal amount.

Diverted trips are similar to passer-by trips except they are attracted to a development from a nearby street or roadway that is not directly adjacent to the site development. Like passer-by trips, diverted trips are not new to the roadway system overall, but their route will include off-site roadways and intersections on the study network. Like passer-by trips, these volumes will be deducted from the through traffic on the original roadway that they were traveling on, and the diverted volumes will be added to the revised route to and from the new developments. For more information on passer-by and diverted trips, please refer to the [ITE Trip Generation Handbook](#), a companion to Trip Generation. The Trip Generation Handbook also includes helpful insight in preparing traffic impact studies, including studies for multi-use developments.

13.4. Freeway Capacity and Design

Traffic Analysis and Design

The purpose of this section is to provide some traffic analysis guidance for design engineers on some of the factors and design elements to consider in operational and road capacity analysis. This information is intended as a supplement to GDOT adopted standards and procedures outlined in the Transportation Research Board (TRB) *Highway Capacity Manual*.

The TRB *Highway Capacity Manual* provides comprehensive guidelines related to freeway traffic analysis and design. Some considerations that must be made during the traffic analysis and design process include, but are not limited to:

- A freeway experiencing extreme traffic congestion differs greatly from a non-freeway facility experiencing extreme congestion since the travel conditions creating the congestion are internal to the facility, not external to the facility.
- Freeway facilities may have interactions with other freeway facilities in the area as well as other classes of nearby roads, and the performance of the freeway may be affected when travel demand exceeds road capacity on these nearby road systems. For example, if the street system cannot accommodate the demand exiting the freeway, the over-saturation of the street system may result in queues backing onto the freeway, which adversely affects freeway travel.
- The traffic analysis and design process must also recognize that the freeway system has several interacting components, including ramps and weaving sections. The performance of each component must be evaluated separately and their interactions considered to achieve an effective overall design. For example, the presence of ramp metering affects freeway demand and must be taken into consideration in analyzing a freeway facility.
- High occupancy vehicle (HOV) lanes require special analysis. If an HOV facility has two or more lanes in each direction all or part of the day and if access to the HOV facility is limited from adjacent freeway lanes (i.e. 1 mile or greater access point spacing), these procedures may be used. Otherwise, HOV lane(s) will have lower lane capacities.

13.4.1. ITS Technology

Intelligent transportation systems (ITS) strategies aim to increase the safety and performance of roadway facilities. For freeway and other uninterrupted-flow highways, ITS may achieve some decrease in headways, which would increase the capacity of these facilities. In addition, even with no decrease in headways, level of service might improve if vehicle guidance systems offered drivers a greater level of comfort than they currently experience in conditions with close spacing between vehicles. “Many of the ITS improvements, such as incident response and driver information systems, occur at the system level. Although ITS features will benefit the overall roadway system, they will not have an impact on the methods to calculate capacity and level of service for individual roadways” (TRB, 2000 p. 2-6).

13.4.2. Capacity Analysis and Level of Service

TRB defines capacity as the maximum hourly rate at which persons or vehicles reasonably can be expected to traverse a point or uniform segment of a lane or roadway during a given period under

prevailing roadway, traffic, and control conditions; adding that “Capacity analysis is a set of procedures for estimating the traffic-carrying ability of facilities over a range of defined operational conditions (2000, p. 2-1)”.

Service flow rates are similar because they define the flow rates that be accommodated while still maintaining a given level of service.

There are numerous factors that affect capacity and LOS:

- base conditions
- prevailing roadway conditions (including geometric and other elements)
- prevailing traffic conditions, which also account for vehicle type (e.g. heavy vehicles) and distribution of vehicles

For design LOS for GDOT roadways, refer to **Chapter 6, Tables 6.1 through 6.4** of this Manual.

Traffic Flow Characteristics

Traffic flow on a freeway can be highly varied depending on the conditions constraining flow at upstream and downstream bottleneck locations. Bottlenecks can be created by ramp merge and weaving segments, lane drops, maintenance and construction activities, accidents, and objects in the roadway. An incident does not have to block a travel lane to create a bottleneck. For example, disabled vehicles in the median or on the shoulder can influence traffic flow within the freeway lanes.

Freeway research has resulted in a better understanding of the characteristics of freeway flow relative to the influence of upstream and downstream bottlenecks. Freeway traffic flow can be categorized into three flow types: (1) under-saturated, (2) queue discharge, and (3) oversaturated. Each flow type is defined within general speed-flow-density ranges, and each represents different conditions on the freeway.

Under-saturated flow represents traffic flow that is unaffected by upstream or downstream conditions. This regime is generally defined within a speed range of 55 to 75 mph at low to moderate flow rates and a range of 40 to 60 mph at high flow rates.

Queue discharge flow represents traffic flow that has just passed through a bottleneck and is accelerating back to the free-flow speed of the freeway. Queue discharge flow is characterized by relatively stable flow as long as the effects of another bottleneck downstream are not present. This flow type is generally defined within a narrow range of 2,000 to 2,300 passenger cars, per hour, per lane (pcphpl), with speeds typically ranging from 35 mph up to the free-flow speed of the freeway segment. Lower speeds are typically observed immediately downstream of the bottleneck. Depending on horizontal and vertical alignments, queue discharge flow usually accelerates back to the free-flow speed of the facility within 0.5 to 1 mile downstream from the bottleneck. Studies suggest that the queue discharge flow rate from the bottleneck is lower than the maximum flows observed before breakdown. A typical value for this drop in flow rate is approximately 5 percent.

Oversaturated flow represents traffic flow that is influenced by the effects of a downstream bottleneck. Traffic flow in the congested regime can vary over a broad range of flows and speeds depending on the severity of the bottleneck. Queues may extend several thousand feet upstream of the bottleneck. Freeway queues differ from queues at intersections in that they are not static or

standing. On freeways, vehicles move slowly through a queue, with periods of stopping and movement.

Speed-Flow and Density-Flow Relationships

The free-flow speed of passenger cars (mph) on freeways is relatively insensitive to flow rate of passenger cars per hour per lane (pcphpl) in the low to moderate range (0 pcphpl to 1,200 pcphpl). Studies have shown that passenger cars operating at a free-flow speed of 70 mph maintain the operating speed for flows up to 1,300 pcphpl. For lower free-flow speed, the region over which speed is insensitive to flow extends to higher flow rates. In general terms, the lower the flow rate, the higher free-flow speed of the vehicle. Similarly, the higher the flow rate, the higher the density, which is measured in passenger car per mile per lane (pc/mi/ln).

Refer to the current TRB *Highway Capacity Manual* Chapter 13, Freeway Concepts, for a detailed discussion and exhibits specific to Speed-Flow and Density-Flow Relationships and factors that affect free-flow speed.

Passenger-Car Equivalentents

The concept of vehicle equivalentents is based on freeway conditions in which the presence of heavy vehicles, including trucks, buses, and recreational vehicles, creates less than base operating conditions. These diminished operating conditions include longer and more frequent gaps of excessive length both in front of and behind heavy vehicles, the speed of vehicles in adjacent lanes, and the physical space taken up by a large vehicle (typically two to three times greater than a passenger car). To allow for these lesser travel conditions and ensure the method for freeway capacity is based on a consistent measure of flow, each heavy vehicle is converted to a passenger-car equivalent. The conversion results in a single value for flow rate in terms of passenger cars per hour per lane (pcphpl). The conversion factor depends on the proportion of heavy vehicles in the traffic stream and the length as well as the severity of the roadway grade.

Driver Population

Studies have shown that non-commuter driver populations display different, less aggressive characteristics than regular commuters. For recreational traffic, capacities have been observed to be as much as 10 to 15 percent lower than for commuter traffic traveling on the same segment

Level of Service (LOS)

Although speed is a major concern of drivers as related to service quality, freedom to maneuver within the traffic stream and proximity to other vehicles are equally noticeable concerns. These qualities are related to the density of the traffic stream. Unlike speed, density increases as flow increases up to capacity, resulting in a measure of effectiveness that is sensitive to a broad range of flows.

The following brief descriptions summarize the different levels of service:

- **LOS A** - Free flow, with low volumes and high speeds (about 90% of free-flow speed). Control delay at signalized intersection is minimal.
- **LOS B** - Reasonably free flow, speeds (70% of free-flow speed) beginning to be restricted by traffic conditions. Control delay at signalized intersection is not significant.

- **LOS C** - Stable flow zone, most drivers restricted in freedom to select their own speed (50% free-flow speed).
- **LOS D** - Approaching unstable flow, drivers have little freedom to maneuver (40% free-flow speed).
- **LOS E** - Unstable flow may be short stoppages. High volumes, lower speeds (33% free-flow speed).
- **LOS F** - Forced or breakdown flow. Intersection congestion is likely at critical signalized locations with high delays and high volumes and extensive queues.

Operating characteristics are represented by a specified LOS ranging from LOS A describing free-flow operations to LOS F describing breakdowns in vehicular flow. Breakdowns occur when the ratio of existing demand to actual capacity or of forecast demand to estimated capacity exceeds 1.00. Vehicular flow breakdowns occur for a number of reasons:

- Traffic incidents can cause a temporary reduction in the capacity of a short freeway segment, so that the number of vehicles arriving at the point is greater than the number of vehicles that can move through it.
- Points of recurring congestion, such as merge or weaving segments and lane drops, experience very high demand in which the number of vehicles arriving is greater than the number of vehicles discharged.
- In forecasting situations, the projected peak-hour (or other) flow rate can exceed the estimated capacity of the location.

Freeway Weaving

Weaving is defined as the crossing of two or more traffic streams traveling in the same direction along a significant length of highway without the aid of traffic control devices (with the exception of guide signs). Weaving segments are formed when a merge area is closely followed by a diverge area, or when an entrance ramp is closely followed by an exit ramp and the two are joined by an auxiliary lane. Weaving segments may exist on any type of facility: freeways, multilane highways, two-lane highways, interchange areas, urban streets, or collector-distributor roadways.

Refer to the current version of the TRB *Highway Capacity Manual*, Chapter 24, for guidance related to freeway weaving.

13.4.3. Ramps and Ramp Junctions

A ramp is a length of roadway providing an exclusive connection between two highway facilities. On freeways, all entering and exiting maneuvers take place on ramps that are designed to facilitate smooth merging of on-ramp vehicles into the freeway traffic stream and smooth diverging of off-ramp vehicles from the freeway traffic stream onto the ramp.

Refer to the current version of the TRB *Highway Capacity Manual* for guidance related to ramps and ramp junctions.

Capacity of Merge and Diverge Areas

There is no evidence that merging or diverging maneuvers restrict the total capacity of the upstream or downstream basic freeway segments. Their influence is primarily to add or subtract demand at

the ramp-freeway junction. Thus, the capacity of a downstream basic freeway segment is not influenced by turbulence in a merge area. The capacity will be the same as if the segment were a basic freeway segment. As on-ramp vehicles enter the freeway at a merge area, the total number of ramp and approaching freeway vehicles that can be accommodated is the capacity of the downstream basic freeway segment.

Similarly, the capacity of an upstream basic freeway segment is not influenced by the turbulence in a diverge area. The total capacity that may be handled by the diverge junction is limited either by the capacity of the approaching (upstream) basic freeway segment or by the capacity of the downstream basic freeway segment and the ramp itself. Most breakdowns at diverge areas occur because the capacity of the exiting ramp is insufficient to handle the ramp demand flow. This results in queuing that backs up into the freeway mainline.

Another capacity value that affects ramp-freeway junction operation is an effective maximum number of freeway vehicles that can enter the ramp junction influence area without causing local congestion and local queuing. For on-ramps, the total entering flow in lanes 1 and 2 of the freeway plus the on-ramp flow cannot exceed 4,600 pc/h. For off-ramps, the total entering flow in Lanes 1 and 2 cannot exceed 4,400 pc/h. Demands exceeding these values will cause local congestion and queuing. However, as long as demand does not exceed the capacity of the upstream or downstream freeway sections or the off-ramp, breakdown will normally not occur. Thus, this condition is not labeled as LOS F, but rather at an appropriate LOS based on density in the section.

If local congestion occurs because too many vehicles try to enter the merge or diverge influence area, the capacity of the merge or diverge area is unaffected. In such cases, more vehicles move to outer lanes (if available), and the lane distribution is approximated.

Levels of service in merge and diverge influence areas are defined in terms of density for all cases of stable operation; LOS A through E. LOS F exists when the demand exceeds the capacity of upstream or downstream freeway sections or the capacity of an off-ramp.

Required Input Data and Estimated Values

Exhibit 13-17, listed on page 13-24 of the TRB *Highway Capacity Manual*, provides default values for input parameters in the absence of local data (Number of Ramp Lanes, Length of Acceleration/Deceleration Lane, Ramp free-flow speed, Length of Analysis Period, PHF, Percentage of Heavy Vehicles, and Driver Population). Exhibits 13-18 and 13-19, listed on page 13-25, provide direction in the determination of acceleration and deceleration lane lengths. Service volumes for ramps are difficult to describe because of the number of variables that affect operations. Exhibit 13-20, listed on page 13-26 of the TRB *Highway Capacity Manual*, provides approximate values (for illustrative purposes only) associated with LOS for single on- and off-ramps.

13.4.4. Traffic Management Strategies

Freeway traffic management is the implementation of strategies to improve freeway performance, especially when the number of vehicles desiring to use a portion of the freeway at a particular time exceeds its capacity. There are two approaches to improving system operation. Supply management strategies work on improving the efficiency and effectiveness of the existing freeway or adding additional freeway capacity. Demand management strategies work on controlling, reducing, eliminating, or changing the time of travel of vehicle trips on the freeway while providing a

wider variety of mobility options to those who wish to travel. However, in actual application, some strategies may address both sides of the supply/demand equation. The important point is that there are two basic ways to improve system performance.

Supply management strategies are intended to increase capacity. Capacity may be increased by building new pavement or by managing existing pavement. Supply management has been the traditional form of freeway system management for many years. Increasingly, the focus is turning to demand management as a tool to address freeway problems. Demand management programs include alternatives to reduce freeway vehicle demand by increasing the number of persons in a vehicle, diverting traffic to alternate routes, influencing the time of travel, or reducing the need to travel. Demand management programs must rely on incentives or disincentives to make these shifts in behavior attractive.

Freeway traffic demand management strategies include the use of priority for high-occupancy vehicles, congestion pricing, and traveler information systems. Some alternative strategies such as ramp metering may restrict demand and possibly increase the existing capacity. In some cases, spot capacity improvements such as the addition of auxiliary lanes or minor geometric improvements may be implemented to better utilize overall freeway system capacity.

Freeway Traffic Management Process

Freeway traffic management is the application of strategies that are intended to reduce the traffic using the facility or increase the capacity of the facility. Person demand can be shifted in time or space, vehicle demand can be reduced by a shift in mode, or total demand can be reduced by a variety of factors. Factors affecting total demand include changes in land use and elimination of trips due to telecommuting, reduced workweek, or a decision to forgo travel. By shifts of demand in time (i.e. leaving earlier), shifts of demand in space (i.e. taking an alternative route), shifts in mode, or changes in total demand, traffic on a freeway segment can be reduced. Likewise, if freeway capacity has been reduced (i.e. as the result of a vehicle crash that has closed a lane or adverse weather conditions), improved traffic management can return the freeway to normal capacity sooner, reducing the total delay to travelers.

The basic approach used to evaluate traffic management is to compare alternative strategies. The base case would be operation of the facility without any freeway traffic management. The alternative case would be operation of the facility with the freeway traffic management strategy or strategies being evaluated. The alternative case could have different demands and capacities based on the conditions being evaluated. The evaluations could also be made for existing or future traffic demands. Combinations of strategies are also possible, but some combinations may be difficult to evaluate because of limited quantifiable data.

Freeway traffic management strategies are implemented to make the most effective and efficient use of the freeway system. Activities that reduce capacity include incidents (including vehicle crashes, disabled or stalled vehicles, spilled cargo, emergency or unscheduled maintenance, traffic diversions, or adverse weather), construction activities, scheduled maintenance activities, and major emergencies. Activities that increase demand include special events. Freeway traffic management strategies that mitigate capacity reductions include incident management; traffic control plans for construction, maintenance activities, special events, and emergencies; and minor design improvements (i.e. auxiliary lanes, emergency pullouts, and accident investigation sites). Freeway traffic management strategies to reduce demand include plans for incidents, special

events, construction, and maintenance activities; entry control/ramp metering; on-freeway HOV lanes; HOV bypass lanes on ramps; traveler information systems; and road pricing.

Capacity Management Strategies - Incident management is the most significant freeway strategy generally used by operating agencies. Incidents can cause significant delays even on facilities that do not routinely experience congestion. It is generally believed that more than 50 percent of freeway congestion is the result of vehicle crashes. Strategies to mitigate the effects of vehicle crashes include early detection and quick response with the appropriate resources. During a vehicle crash, effective deployment of management resources can result in a significant reduction in the effects of the incident. Proper application of traffic control devices, including signage and channelization, is part of effective incident management. Quick removal of crashed vehicles and debris is another part. Incident management may also include the use of accident investigation sites on conventional streets near freeways for follow-up activities.

Demand Management Strategies - The number of vehicles entering the freeway system is the primary determinant of freeway system performance. Entry control is the most straightforward way to limit freeway demand. Entry control can take the form of temporary or permanent ramp closure. Ramp metering, which can limit demand on the basis of a variety of factors that can be either preprogrammed or implemented in response to a measured freeway conditions, is a more dynamic form of entry control. Freeway demand can be delayed (changed in time), diverted (changed in space to an alternative route), changed in mode (such as HOV), or eliminated (the trip avoided). The difficult issue in assessing ramp metering strategies is estimating how demand will shift as a result of metering.

HOV alternatives such as mainline HOV lanes or ramp meter by pass lanes are intended to reduce the vehicle demand on the facility without changing the total number of person trips. Assessing these types of alternatives also requires the ability to estimate the number of persons who make a change of mode to HOV. In addition, it is necessary to know the origin and destination of the HOV travelers to determine what portions of the HOV facility they can use, since many HOV facilities have some form of restricted access.

Special events result in traffic demands that are based on the particular event. These occasional activities are amenable to the same types of freeway traffic management used for more routine activities such as daily commuting. In the case of special events, more planning and promotion are required than are typically needed for more routine activities.

Road pricing is a complex and evolving freeway traffic management alternative. Initially, road pricing involved a user fee to provide a means to finance highways. More recently, toll roads have been built as alternatives to congestion. Now, congestion-pricing schemes are being implemented to manage demand on various facilities or in some cases to sell excess capacity on HOV facilities. The congestion-pricing approach to demand management is to price the facility such that demand at critical points in time and space along the freeway is kept below capacity by encouraging some users during peak traffic periods to consider alternatives. Nontraditional road pricing schemes are still in their infancy, so little information is currently available on their effects compared with more traditional toll roads, which view tolls only as a means to recover facility costs.

13.5 Arterial Capacity and Design

Arterials are a functional classification of street transportation facilities that are intended to provide for through trips that are generally longer than trips on collector facilities and local streets. While the need to provide access to abutting land is not the primary function, the design of arterials must also balance this important need. To further highlight the often competing demands of urban arterials, it should be recognized that other modes of travel such as pedestrians and public transit are also present and must be accommodated.

To assure that arterials can safely provide acceptable levels of service for the design conditions, a number of design elements must be addressed. Since each design element is essentially determined based on separate analyses, the designer should then evaluate the entire arterial system and be prepared to refine certain elements to obtain an effective and efficient overall design.

13.5.1. Capacity Analysis and Level of Service (LOS)

Capacity analysis is the key method to establish the number of travel lanes that will be needed to accommodate the design conditions. The design principles of this document are intended to be consistent with the methodology as outlined in the latest edition of the TRB *Highway Capacity Manual* (HCM).

Capacity analysis software is essential to allow the designer to evaluate design alternatives in a timely manner. Several capacity analysis programs are acceptable, including The Highway Capacity Software (HCS), Synchro, and CORSIM. Other analysis packages should be discussed with the GDOT project manager prior to submitting as project documentation.

When conducting capacity analysis, the analyst will use reasonable timing parameters. When the arterial has a number of signalized intersections that are spaced less 1,500-ft., then system operation is likely. In such cases, the capacity analysis will use the cycle length requirements from the critical intersection for all intersections.

The traffic analysis will also consider pedestrian requirements. When significant pedestrian crossing volumes are expected, the capacity analysis will include minimum pedestrian intervals.

The arterial LOS in the current HCM is based on the average travel speed for the segment, section or entire arterial under consideration. This is the basic measure of effectiveness (MOE). The design engineer should refer to the current HCM for detail discussion and description of LOS.

The analysis method in the current HCM uses the AASHTO distinction between principal and minor arterials, but uses a second classification step to determine the design category for the arterial. The design criteria depend on factors such as: posted speed limit, signal density, driveway/access-point density, and other design features.

The third step in the capacity analysis process is to determine the appropriate urban arterial class on the basis of a combination of functional category and design category. Refer to the *HCM* Chapter 10, for a detailed description of functional and design categories.

13.5.2. Traffic Analysis Procedures

The traffic analysis and design generally includes the following elements: the typical section, access management, and intersection design. The following sections will address each of these areas.

Determination of Typical Section

To begin the conceptual design of an arterial, the number of travel lanes that are needed on the mid-block segments can be estimated based on ideal capacities. The ideal capacity of a two lane roadway is 1,700 vehicles per hour (vph) in each direction. The ideal capacity of a multi-lane roadway is 2,000 vph per lane. Capacity analysis should be used to check that acceptable levels of service can be achieved with the selected typical section and the design traffic data. The following general guidelines are provided to assist in the process of establishing typical sections:

- Two-lane roadways are generally acceptable only if the Design Hour Volume (DHV)¹ are less than 800 vph in either direction.
- Undivided multi-lane roadways are typically limited to areas where the posted speed limit is no greater than 40 mph and the DHV does not exceed 3,000 vph in either direction.
- Continuous two-way left turn lanes may be considered for roadways with typical sections having a number of closely spaced intersections with low-volume streets when the main roadway has no more than four lanes.

Access Management

Access management involves many techniques, ranging from zoning and subdivision regulations to highway design aspects and driveway access controls. For additional information related to Access Management, see **Section 3.5.** of this Manual.

For additional information relating to driveway and access controls, including permit procedures, access criteria, and geometric design criteria, refer to the most current version of the *GDOT Regulations for Driveway and Encroachment Control*².

13.5.3. Intersection Traffic Control and Design

After the typical section is determined and the location of median breaks are determined (if the facility is divided), the traffic analysis should then focus on the intersections. It will be necessary to determine the type of traffic or right of way control and the need for turning lanes. Since the type of traffic control affects the intersection design, it is first necessary to determine if traffic signal control will be needed. An example of this influence on intersection design is that designers will typically limit the number of lanes on stop controlled approaches to avoid vehicles stopping abreast of each other and blocking sight distance from the other vehicle. When multiple lanes are needed on stop

¹ **Design Hour Volume (DHV)** – The traffic volume expected to use a highway segment during the 30th highest hour of the design year. The Design Hour Volume (DHV) is related to Annual Average Daily Traffic (AADT)* multiplied by the K-Factor (K)**.

***Annual Average Daily Traffic (AADT)** – The total volume of traffic on a highway segment for one year, divided by the number of days in the year. This volume is usually estimated by adjusting a short-term traffic count with weekly and monthly factors. (AASHTO)

****K-Factor (K)** – Proportion of 24-hour volume occurring during the design hour for a given location or area.

² GDOT. (2009). *Regulations for Driveway and Encroachment Control*. Available online at: <http://www.dot.ga.gov/PartnerSmart/DesignManuals/Encroachment/DrivewayFull.pdf>

controlled approaches, the design will include islands and/or increased turning radii to separate through and turning vehicles.

The need for traffic signal control is obvious at many intersections that are currently signalized. However, at other intersections traffic signal warrant analysis may be needed to establish the need for traffic signal control. At some intersections, where traffic signals are not currently needed, future traffic increases may warrant signal control. For such intersections, a warrant analysis should be conducted for both the construction year volumes as well as for the design year volumes. Warrant analyses should be conducted using the guidelines of the most current edition of the *MUTCD*.

Signal warrants are typically conducted using hourly volumes throughout the normal day (not just peak hour volumes (PHV)³). Since the design volumes are limited to peak hour and daily volumes, it will be necessary to derive estimates of the volumes that occur during the remaining hours of the day.

An important signal warrant is Warrant 1, Eight-Hour Vehicular Volume. Therefore, the traffic analysis should estimate the eighth-highest volume of the day. The eighth-highest volume can be compared to the requirement of Warrant 1 to estimate if this important warrant will be satisfied with the projected volumes.

The eighth-highest volume can be estimated as representing 5.6 % of the daily volume. If the eighth-highest volume exceeds the minimum volumes for Warrant 1 using the construction year volumes, then signal control should be considered for installation during the construction project.

If Warrant 1 is only met using the design year⁴ conditions, then signalization may not be included with construction, but the design may reflect the need for future signal control. For example, turn lanes may be constructed and striped out until signals are installed.

Traffic Signal Permitting Process

There are three distinct roadway systems in Georgia. These are the county roads, the city streets and the state routes. The Georgia Department of Transportation has authority over the state route system. Georgia Law empowers GDOT with the authority to set standards for all public roads in Georgia. Because traffic signals are used at many intersections where state routes cross city streets or county roads, and because traffic signals are most often installed to meet a Local community need, a permit process to allow local governments to erect, operate and maintain traffic signals on state routes has been established. This formal process has been ongoing since the early 1950's. The authority to create uniform regulations and to place or cause to place traffic control devices on state routes is described in section 32-6-50 of the Official Code of Georgia.

Requests for traffic signals come to GDOT from a wide variety of sources. State, city and county elected officials responding to their constituents will often request GDOT to evaluate an intersection for a traffic signal. Requests may also be received directly into GDOT from concerned citizens. All

³ **Peak Hour Volume (PHV)** – The 30th highest hour of the Base (Opening) Year.

⁴ **Design Year** – Usually twenty years from the Base (Opening) Year. The year for which the roadway is designed.

inquiries are considered a request for assistance and should be investigated to determine if a signal or some less restrictive improvement should be implemented.

Requests for signals are evaluated using the warranting values found in the *MUTCD*. These warrants will be the minimum criteria for further study. Intersection evaluations indicating a signal will not meet any warrant may be denied by a letter of response from the District Traffic Operations Office. Intersections that will meet one or more of the *MUTCD* warrants will be studied further for justification.

All traffic signal devices erected on the state route system must have a permit application from the local government to GDOT and a Traffic Signal Authorization issued by GDOT prior to their installation. These permit documents serve as the agreement between GDOT and the local government for the signal. Even in communities where signals are maintained by GDOT, a formal document of agreement is needed. The permit application is used to allow the local government to formally request the use of a traffic signal. This application indicates the approval of the local government for the use of the signal. It also commits local government to provide electrical power and telephone service for the intersection.

The Traffic Signal Authorization is the permit indicating the formal approval of GDOT for the use of the traffic signal at the intersection. Design drawings are a part of the authorization form showing the intersection details, the signal head arrangement, the signal phasing and the detector placement. Regardless of the method of funding and installation, a signal authorization is needed. The original of this authorization is kept in the Office of Traffic Operations with copies sent to the District Office and from the District Office to the local government for their records.

Once a request is received, the District Traffic Engineer, using the methods described in the Manual on Uniform Traffic Control Devices, should initiate an engineering study. The study should first consider less restrictive measures such as improved signing, marking, sight distance, operational improvements, etc. If less restrictive measures cannot be effectively implemented, a traffic signal should be considered if the conditions at the intersection satisfy one or more of the warrants in the *MUTCD*.

The completed Traffic Engineering Study shall have a signature page that includes the conclusions of the study and the recommendations of the District Traffic Engineer. Approval blocks should be included for the District Engineer (optional), State Traffic Engineer, and Division Director of Operations.

Once completed, the Traffic Engineering Study will be sent to the Office of the Traffic Operations for review and approval. If the signal is found to be justified by the Traffic Engineering Study, a Traffic Signal Authorization will be recommended for approval by the State Traffic Engineer. A permit approval form will be prepared by the Office of Traffic Operations, and the entire package will be sent to the Division Director of Operations for recommendation and to the Chief Engineer of GDOT for final approval. A copy of the approved permit and the design will be returned to the District Traffic Operations Office for transmittal to the local government for their records.

Signal permit revisions will be required for all changes made to the signal operation or design. Any addition of vehicle or pedestrian phases, modifications in phase sequences, modifications to signal head arrangements or other similar operational changes will require a permit revision. A request from the District outlining the changes needed and justifying the changes will be submitted in

writing. A permit revision authorization will be issued with the appropriate design drawings similar to those required for a new signal.

It is appropriate for new signals to be included in roadway projects if a need has been identified. Even in these circumstances the permit application, the signal authorization and Traffic Engineering Study are necessary for new signals to be installed in roadway projects. Existing signals requiring upgrading to meet the needs of the reconstructed roadway may be included in the construction project. A permit revision should be requested as outlined above.

The Traffic Engineering Study prepared for the intersection proposed for signalization must adequately document two things. First, there is a need for this degree of control, and second, the analysis demonstrates that the signal operation will be beneficial to the state highway system. When these conditions are met, the State Traffic Engineer will recommend approval of the permit to the Division Director of Operations and Chief Engineer. The District Traffic Engineer should be the primary initiator for new signals on construction projects. This is to be accomplished as early in the project life as is possible, preferably at the design concept stage, and certainly should be accomplished by the preliminary field inspection (PFPR) since the use of signals will usually affect the roadway design.

Due to the detrimental effect of traffic signals on the flow of arterial traffic a traffic signal may not always be to the benefit of the state highway system. Therefore, it is likely that signals which are justified by design year traffic volumes will be denied or deferred if initial traffic volumes do not warrant their inclusion in the project. The Traffic Engineering Study is even more important in this case as it will document conditions at a point in time and will assist in the decision making process to determine the right time to approve signalization.

Pedestrian Accommodations at Signalized Intersections

Crosswalks and pedestrian signal heads, including ADA considerations, shall be installed on all approaches of new traffic signal installations or revised traffic signal permits unless an approach prohibits pedestrian traffic. Exceptions may be granted if the pedestrian pathway is unsafe for pedestrians or the Traffic Engineering Study documents the absence of pedestrian activity. The District traffic engineer, project manager, consultant, local government, or permit applicant must document the conditions and justification for eliminating pedestrian accommodations for each approach being requested. The documentation will be included in the permit file if accepted.

In the case of one or more pathways being determined unsafe to cross at a signalized intersection, appropriate *MUTCD* signing prohibiting pedestrian traffic must be erected. Use of *MUTCD* signing may also be appropriate when it is necessary to restrict access to one pedestrian pathway.

Prior to the Traffic Engineering Study recommending that pedestrian accommodations be eliminated based on the absence of pedestrian activity, the entity preparing the report should consider the existing development near the intersection, expected development within the next five year period, and input from local government. If any of these indicators project potential pedestrian activity the report should recommend pedestrian accommodations be included.

Turn Lanes at Stop Controlled Intersections

At stop controlled intersections, the number of lanes on the stop controlled approaches will normally be minimized. However, it may be desirable to provide a separate, channelized lane for the right turning traffic.

It is desirable to provide separate lanes for vehicles that are preparing to turn off of the arterial roadway, when such turning volumes are significant. Guidelines for determining when such volumes are significant can be found in National Cooperative Highway Research Program (NCHRP) *Evaluating Intersection Improvements: An Engineering Study Guide*⁵, commonly referred to as NCHRP Report 457.

Turn Lanes at Signal Controlled Intersections

The need for turn lanes at signal controlled intersections can also be evaluated using the guidelines found in NCHRP 457. However, capacity analysis will also be the basis for establishing the need for turn lanes and determining when multiple turn lanes are needed.

Although capacity analysis is used to identify potential needs for installing multiple turn lane bays, judgment must be used. For example, when providing dual left turn lanes, turn phases are generally operated in an “exclusive-only” manner. If dual turn lanes provide only marginal improvement over single turn lanes operated with protected/permitted phasing, it should be recognized that single turn lanes actually operate better during the off-peak times.

After the need for turn lanes is established, it is then necessary to define the length of tapers and full storage. Capacity analysis will result in estimated lengths of queues. In general, full width storage will be provided that is sufficient to store the estimated queue lengths of turning vehicles.

The traffic engineer will use judgment to evaluate the interaction of queues resulting from the different movements at the approach to an intersection. For example, left turn bays are sometimes “starved” due to the presence of long vehicle queues in the through lanes that block access to the left turn bay. When the estimated queue lengths of turning vehicles is less than but comparable to the queues for through vehicle, then the turn lane for the turn movement should be extended based on the queues in the through lanes. However, engineering judgment should be employed when making such decisions. As an example, if the through queues are estimated to be 800-ft. and the volume of left turn traffic is only 10 vph, then the left turn lane should not be extended to 800-ft. for such a small volume.

Drop Lanes

When multiple turn lane bays are found to be needed on the arterial, it may be necessary to widen the intersecting roadway to accommodate an additional receiving lane. This widening should be extended to the next downstream intersection. However, as a minimum, the widening should be a sufficient distance downstream from the intersection in order to make the multiple turn lanes operate effectively and provide an adequate merging area. The additional lane may need to be expanded to the next downstream intersection.

The traffic analysis will consider the distance that should exist on the receiving lanes prior to a lane drop. The length of this distance will affect the lane utilization and appropriate lane utilization factors will be included in the capacity analysis. The traffic analysis will provide a recommended length of widening based on the capacity analysis and the expected lane utilization.

⁵ NCHRP. *CHRP Report 457*, "Evaluating Intersection Improvements: An Engineering Study Guide." 2001

Highly Congested Urban Areas

In many highly developed urban areas, it may be infeasible to meet the desirable level of service criteria. The following are examples:

- Capacity analysis indicates a high number of lanes (more than 6 lanes) needed to accommodate the design volumes
- Capacity analysis indicates grade separation would be required at major intersections
- The required improvements would require the acquisition and demolition of significant existing structures

When the traffic analysis indicates that it will be infeasible to meet the LOS standard, these conditions will be documented in the traffic analysis. The traffic engineer will then prepare an incremental analysis. An incremental analysis will typically address each five-year period within the twenty-year design period.

The traffic engineer must then request incremental traffic projections or assume linear increase throughout the design period. The incremental analysis will enable the traffic engineer to identify feasible improvements and report the expected operating conditions with these improvements at each incremental time period.

Chapter 14. Lighting - Contents

Chapter 14. Lighting - Contents	14-i
14.1. Overview	14-1
14.1.1. Applicable References.....	14-1
14.2. General Considerations	14-1
14.2.1. Project Types	14-1
14.2.2. Warranting Conditions	14-2
14.2.3. Existing Lighting Systems	14-3
14.2.4. Lighting Agreements	14-3
14.3. Illumination Requirements	14-4
14.3.1. Design Considerations	14-4
14.3.2. Continuous Roadway	14-7
14.3.3. Intersections and Roundabouts.....	14-7
14.3.4. Vehicular Underpasses/Tunnels.....	14-8
14.3.5. Pedestrian facilities	14-9
14.3.6. Parking Facilities	14-10
14.3.7. Toll Plazas.....	14-10
14.3.8. Aesthetic Lighting	14-10
14.3.9. Permitted Lighting	14-10
14.4. Design Criteria	14-10
14.4.1. Photometric Submittals	14-10
14.4.2. Light Standard Location	14-11
14.4.3. Structural Requirements.....	14-12
14.4.4. Power Service	14-12
14.4.5. Electrical Design.....	14-13
14.4.6. Grounding.....	14-15
14.5. Material Requirements.....	14-15
14.5.1. Luminaires.....	14-15
14.5.2. Electrical Materials	14-15

Chapter 14. Lighting

14.1. Overview

The purpose of this chapter is to provide a comprehensive source of information pertaining to the Department's current policies for roadway lighting installations. The material presented in this chapter establishes uniform procedures and standards for roadway lighting system design. The lighting requirements are based on the industry consensus of providing maximum benefits at a practical costs. Refer to the [GDOT Lighting Design Process](#) flowchart for additional guidance.

14.1.1. Applicable References

Refer to the most current edition of the following publications for the planning and design of lighting systems.

- [FHWA Lighting Handbook](#). Federal Highway Administration (FHWA).
- [Roadway Lighting Design Guide](#), American Association of State Highway and Transportation Officials (AASHTO)
- [Guideline for Security Lighting for People, Property and Critical Infrastructures](#) G-1, Illumination Engineering Society of North America (IES).
- [Luminaire Classification System for Outdoor Luminaires](#), TM-15, IES.
- [Nomenclature and Definitions for Illumination Engineering](#), RP-16, American National Standards Institute (ANSI)/IES.
- [Recommended Practice for Design and Maintenance of Roadway and Parking Facility Lighting](#), RP-8, ANSI/IES.
- [The Lighting Handbook, Reference and Application](#), HB-10, IES.
- [Lighting for Exterior Environments](#), RP-33, ANSI/IES.

14.2. General Considerations

14.2.1. Project Types

Roadway lighting may be initiated by either GDOT, a local government, or a private developer often to enhance one of the following transportation facility types.

- Aesthetic improvement – examples include streetscape projects and bridge lighting.
- Parking facilities – example of facilities with parking include welcome centers, rest areas, truck weigh stations, and park-and-ride lots.
- Pedestrian facilities – examples include sidewalks, shared-use paths, streetscape, and mid-block crossings.
- Roadways – examples include urban interstates and corridors, conventional and innovative intersections, urban and rural interchanges, and locations with high nighttime crash history.

- Tunnels – this may include roadway tunnels, underpasses, and pedestrian or shared-use path under crossings.

There are four primary methods for accomplishing a roadway lighting project:

- (1) **Lighting included in parent roadway project** – Project Management assigned to the Office of Program Delivery. The need and extent of lighting should be decided during the concept development of the parent roadway project.
- (2) **Stand-alone lighting project** – Project Management assigned to the Office of Program Delivery. Requests for a stand-alone lighting project should be made in writing to the GDOT Commissioner.
- (3) **Lump Sum (LS) Lighting Program** – Project Management assigned to the Office of Program Delivery for new installations or system upgrades. Lump sum funds may be used to fund repairs, in which Program Management is assigned to the Roadway Lighting Group. Request for funding under the GDOT LS Lighting Program must be sent to the Commissioner.
- (4) **Utility Permit** – Lighting initiated by local government or private developer to be contained on state right-of-way. Utility Permits are managed by the State Utilities Office. District Utility Offices are involved in the early coordination with the local government/developer and oversight during installation and maintenance.

The Roadway Lighting Group will review and the Office of Utilities keeps archives of all GDOT lighting permits. Any inquiries to the existence of a lighting permit should be forwarded to the Office of Utilities.

14.2.2. Warranting Conditions

Section 3.2 of the AASHTO Lighting Design Guide outlines conditions for lighting rural interchanges, continuous freeway lighting, complete interchange lighting, partial interchange lighting, and lighting on bridges in addition to other special lighting considerations. Refer to the FHWA Lighting Handbook for other methods relating to arterials, collectors and local roads. In accordance with **Section 8.2.4** of this manual, lighting is required at all roundabouts.

It is important to note that warrants do not represent a requirement to provide lighting. Satisfying a lighting warrant does not in itself require or obligate GDOT to install a lighting system. The warranting conditions are only used as a basis for establishing if lighting may be justified for a particular project.

Some significant conditions that may warrant lighting are:

- A large number of nighttime vs. daytime crashes
- High traffic volumes
- Use of substandard geometric design values
- Pedestrian presence
- Aesthetics/Business attraction
- Any roadway with four or more lanes of traffic in one direction

- New interchanges
- Urban freeway or arterial

14.2.3. Existing Lighting Systems

Regardless of the impact of proposed construction on an existing lighting system, photometric calculations must be evaluated for the final roadway condition. The result of this evaluation may be either to retain the existing lighting system or install a new lighting system, or combination of the two. Where there is a roadway parent project, any required relocation, upgrade, or replacement of an existing lighting system will be included in that project.

Even if the existing lighting system meets the photometric requirements of the final roadway condition, the system may still need to be replaced to ensure that the remaining useful life of the lighting system components (e.g., towers, poles, luminaires etc.) extends to the end of the design period of the project. Retaining components beyond their useful life (typically 20 to 25 years) could significantly increase maintenance costs.

14.2.4. Lighting Agreements

GDOT may be responsible for the preliminary engineering, materials, and installation costs associated with lighting, or share a portion of these costs with the local government - depending on who initiates the lighting and how it is accomplished. In all cases, the local government will be responsible for 100% of the energy, operation, and maintenance of the lighting system.

Even though most lighting systems are located on GDOT right-of-way, they are energized, operated and maintained by the local government. As such, a written lighting agreement is required between GDOT and the maintaining agency for any lighting elements located within GDOT right-of-way. These agreements detail responsibilities for energy, operations, and maintenance. Responsibilities for lighting systems may be addressed in a Local Government Lighting Project Agreement (LGLPA), Project Framework Agreement (PFA), Memorandum of Agreement (MOA), or Maintenance Agreement. Listed below are some requirements related to these agreements:

- These agreements typically cover a period of 50 years and allow GDOT access to the lighting system during this extended period.
- Lighting agreements are specific to a roadway location and MUST match the proposed lighting system at the project location.
- If an existing agreement is in place, the need for a new agreement will be determined by the Roadway Lighting Group, of the Office of Design Policy and Support.
- The physical location of the lighting system does not need to be within the jurisdiction of the responsible local government; they may request to be responsible for a lighting system that is outside their jurisdiction.
- Required lighting agreements and permits must be in place prior to installing the lighting system.
- Where federal funds are used or if the lighting is located on GDOT right-of-way, the lighting system must be designed by a GDOT prequalified lighting design consultant.

14.3. Illumination Requirements

14.3.1. Design Considerations

Roadway Classification

Below are the *RP-8* roadway classifications. Refer to **Sections 10.2 & 11.3** of the current *RP-8 IES Roadway Lighting* publication for other definitions and classifications of the various types of roadway, pedestrian and bicycle facilities.

- *Freeway* – a divided highway with full control of access
- *Expressway* – a divided highway with partial control of access
- *Major* – roadway that serves as the principle network for through-traffic flow
- *Collector* – roadway which connects Major roadways with Local roadways
- *Local* – roadway with direct access to residential, commercial or industrial properties

Pedestrian Conflict Area Classification

Three classifications of pedestrian night activity levels and the types of land use with which they are typically associated are given below:

- *High* – areas with significant numbers of pedestrians expected to be on the sidewalks or crossing the streets during darkness. Examples include downtown retail areas, near theaters, concert halls, stadiums, college campuses, and transit terminals.
- *Medium* – areas where lesser numbers of pedestrians utilize the streets at night. Examples include downtown office areas, blocks with libraries, apartments, neighborhood shopping, industrial, parks, and streets with transit lines.
- *Low* – areas with very low volumes of night pedestrian usage. Examples include suburban residential areas, low density urban residential areas and rural areas.

Refer to **Section 11.3.3** of the current *RP-8* for additional guidance. Multiple roadway classifications or pedestrian conflict areas may be necessary within the project limits depending on the roadway types and potential pedestrian conflicts. The designer should choose the appropriate classification for each location.

Extent of Lighting

Designers should contact the Roadway Lighting Group, of the Office of Design Policy and Support, with any questions regarding the lighting limits prior to the start of design, and as needed, throughout the life of the project.

Full interchange lighting, where warranted and desired, should cover all mainline lanes, ramps and their respective intersections with the intersecting road as well as the intersecting road between the ramp termini. Lighting along the mainline roadway should be provided at least 1,000 feet from the gore point, but ideally to the point where the inside edge of the ramp lane meets the outside edge of the outer mainline lane. See **Figure 14-1 Example of Lighting at a Ramp Gore** for further clarification.

Partial interchange lighting should include lighting at the ramp terminals and ramp termini intersections as outlined within **Section 10.4.2** of *RP-8*.

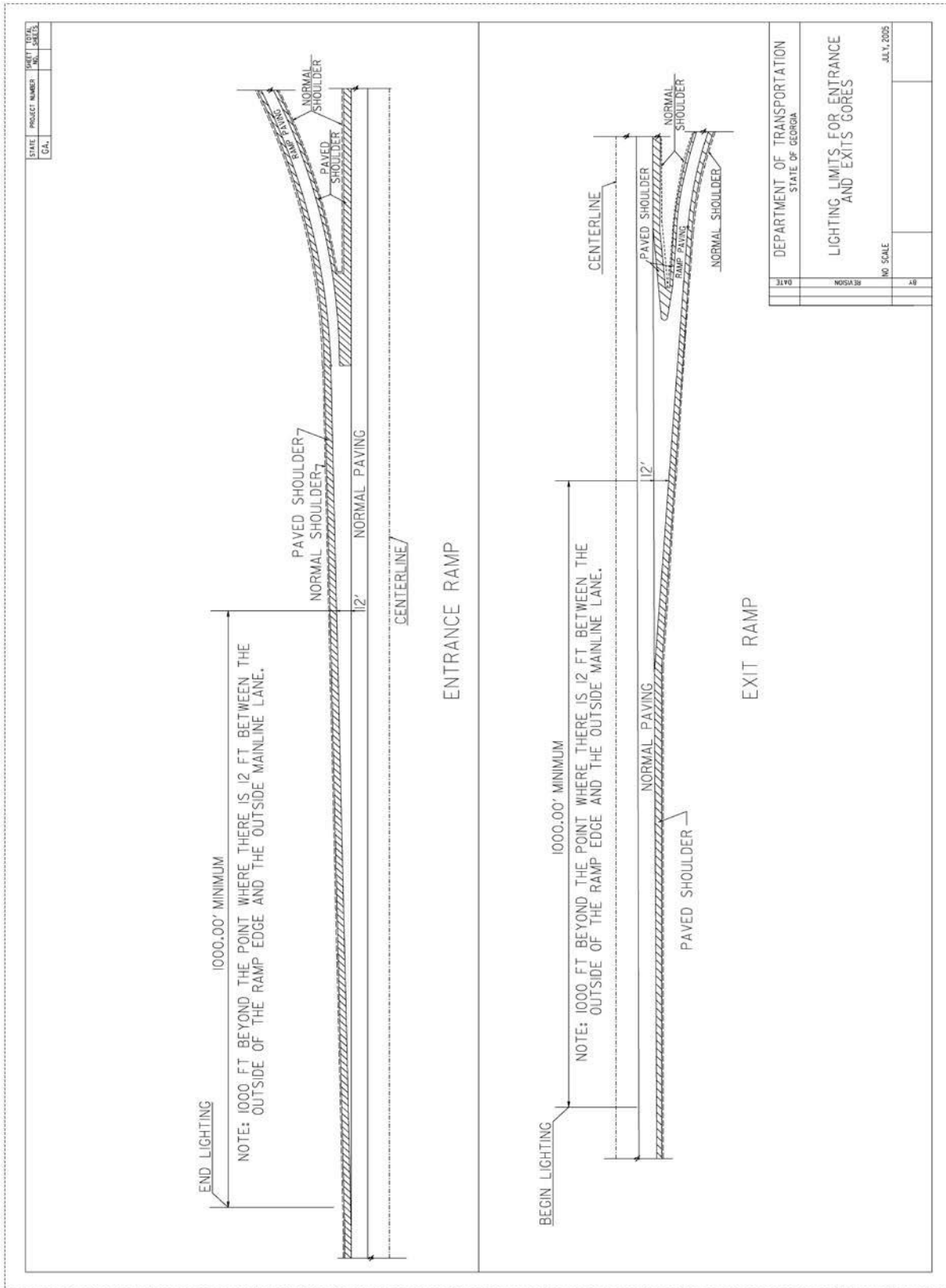

Figure 14-1 Example of Lighting at a Ramp Gore

14.3.2. Continuous Roadway

The luminance, illuminance, uniformity ratio and veiling luminance ratio on a roadway should be in accordance with *RP-8*. A Light Loss Factor (LLF) of 0.8 must be used to compute all maintained illuminance values for LED applications. For all other light sources, a maximum LLF of 0.7 should be used. Road surface classifications should be either R1 ($Q_0=0.10$) or R3 ($Q_0=0.07$), depending on the pavement type. See Table 3.1 for further guidance.

For lighting along roadways, the following is required for photometric review submission:

- (1) Roadway Luminance
- (2) Average/Minimum Luminance Ratio
- (3) Maximum/Minimum Luminance Ratio
- (4) Roadway (Horizontal) Illuminance
- (5) Maximum Veiling Luminance Ratio
- (6) Average Vertical Illuminance for any painted crosswalks within intersections or along roadways. Refer to **Sections 12.5 & 12.6** of the current *RP-8* for guidance.

Design criteria vary based on roadway classification – see **Tables 10.1 & 11.1** in the current *RP-8* for specific criteria.

Any landscaping or existing lighting must be included in the photometric calculations.

14.3.3. Intersections and Roundabouts

Intersections

Lighting systems for intersections of continuously illuminated streets should be designed to comply with recommended illuminance values defined in **Tables 12.1 & 12.2** of *RP-8*. As stated in *RP-8*, illuminance values should be increased if the intersecting streets are illuminated above recommended values. The intersection should be designed such that it is brighter than any approach roadway.

Lighting should be positioned ahead of crosswalks to improve the visibility of pedestrians to drivers. This approach provides a positive contrast for the pedestrians against a darker background. Therefore, at least one pole should be positioned in advance of marked crosswalks.

For intersections on roadways that are not continuously illuminated, a partial lighting system can be utilized in accordance with **Section 12.3.2.2** of *RP-8*. Partial lighting should illuminate, potential conflict points, e.g. entries and pedestrian crossings. Partial lighting is part of an overall intersection “visibility package”. The “visibility package” consists of a combination of lighting and retroreflective traffic control devices (e.g., pavement markings, raised pavement markers, object markers, and signs). The combined effect provides retroreflective identification of fixed objects (e.g. raised curbs) and illumination of conflict areas where intersection users must be able to view the movement of other users (e.g. pedestrians and motorized and non-motorized vehicles).

For intersections and roundabouts, the following is required for photometric review submission:

- (1) Average horizontal illuminance for the calculation area, which includes the entire paved intersection area within the outside limits of crosswalks, at minimum.

Note: If transition lighting is required, the area of transition lighting should be included as part of a separate calculation.

- (2) The ratio of average to minimum horizontal illuminance (E_{avg}/E_{min}) for the same calculation area.
- (3) Average vertical illuminance for marked crosswalks. This average should be greater than or equal to the recommended average horizontal illuminance for the roadway in which the crosswalk is located.

Any landscaping or existing lighting must be included in the photometric calculations.

Roundabouts

Lighting plans for roundabouts should be developed consistent with illuminance values published in **Table 12.4** of *RP-8*. For roundabouts on roadways that are not continuously lighted, the illuminance values in **Table 12.2** of *RP-8* should be used. If transition illumination is not required (see next section), a visibility package as mentioned above is required for unlit approaches.

Adequate lighting should be provided at conflict areas (including motor vehicle, bicycle, and pedestrian conflict areas), and places where the traffic streams separate to exit the roundabout. Lighting should be placed around the perimeter of the roundabout, not within the central island. High mast towers are generally not appropriate for roundabouts, except at interchanges.

The roundabout calculation grid should include all paved areas of a roundabout and extend to the crosswalk area. The central island is not included in the calculation area.

Transition Lighting

Where approach roads are not illuminated, transition lighting may be required. Transition lighting is needed for roadways with designed luminance values of greater than 0.6 cd/m^2 . Per *RP-8*, this luminance value is approximately equivalent to an illuminance level of 0.6 fc for R1 pavement (e.g., Portland cement concrete) and 0.8 fc for R2/R3 pavement (e.g., asphalt concrete). In reference to IES *RP-8* **Table 12.2**, these values cover the range of road classifications (major to local) for isolated intersections. As a result, only isolated approaches to intersections designed with illuminance levels greater than these values may require transition lighting. This may include, for example, intersections with one or two continuously lit approaches that cause the overall illuminance level of the intersection to be higher than that for a completely isolated intersection.

If provided, the transition lighting should be designed for one half of the design illuminance for the intersection for a distance equivalent to 15 seconds of travel time at the prevailing speed of the intersection, measured in the departure direction (from the lighted area to unlighted area). Alternatives to transition lighting may be considered.

The need for lighting on mini-roundabouts will be handled on a case-by-case basis.

Any landscaping or existing lighting must be included in the photometric calculations.

14.3.4. Vehicular Underpasses/Tunnels

Chapter 14 of the current *RP-8* defines conditions where an underpass can be classified as a tunnel. If the underpass classifies as a tunnel, then underpass luminaires may be needed.

Daytime lighting for vehicular tunnels should comply with *RP-8*. According to the *AASHTO Roadway Lighting Design Guide*, a vehicular tunnel that is less than 80-ft does not require daytime lighting; however, the need for night time lighting will still need to be evaluated based on the illuminance levels of the adjacent roadway. A vehicle tunnel over 410-ft requires daytime lighting. A vehicle tunnel between the lengths of 80- to 410-ft should be evaluated to determine if daytime lighting is warranted. Refer to the *AASHTO Roadway Lighting Guide*, Chapter 4, for further guidance.

For daytime lighting, the following is required for photometric review submission:

- (1) Daytime lighting warrant study to justify the inclusion of lighting on the project. This should be submitted to the Roadway Lighting Group, within the Office of Design Policy & Support, for review and concurrence.
- (2) Daytime lighting design criteria, including driver direction, tunnel length, Lseg or similar, posted speed limits, pedestrian/bicycle presence, annual average daily traffic (AADT), daylight penetration, among other factors that support justification for the lighting design criteria.
- (3) Average Daytime Luminance through the Threshold zone, along with the Threshold limits. Corresponding step down areas, if necessary, must also be provided along with corresponding lengths.

The reflective characteristics of pavement, wall, and ceiling materials shall be considered when calculating roadway illuminance values. The lighting designer will need to account for daylight penetration into the tunnel or underpass. Luminance and Veiling Luminance grids should be configured such that they run through the underpass to verify the underpass fixtures do not create a glare issue. A maximum LLF of 0.65 should be used to compute maintained luminance values for all light sources.

If possible, luminaires should be wall mounted at a location where they can be maintained without requiring a lane closure. Coordination with the GDOT Office of Design Policy & Support and Office of Bridge Design is required to mount luminaires on bridge superstructures or above active lanes.

Dimming control systems may be considered in all designs.

Any landscaping or existing lighting must be included in the photometric calculations.

14.3.5. Pedestrian facilities

Pedestrian facilities that generally follow the alignment of the adjacent roadway should comply with *RP-8*. However, calculation grids for these pedestrian facilities should be separate from the roadway calculations. Pedestrian facilities that do not follow the alignment of a roadway, such as shared-use paths and pedestrian underpass tunnels, shall meet the requirements of Chapter 16 of the current *RP-8*. A LLF of 0.8 should be used to compute maintained illuminance values for LED applications. For all other light sources, a maximum LLF of 0.7 may be used.

The entrance/exits of pedestrian tunnels should be illuminated, in addition to the interior of the pedestrian tunnel itself. All pedestrian tunnel luminaires and electrical equipment should be vandal proof.

For any project which has existing or proposed pedestrian facilities, such as sidewalk or shared-use paths, the following is required for photometric review submission for each pedestrian facility:

- (1) Average Horizontal Illuminance
- (2) Minimum Vertical Illuminance
- (3) Average/Minimum Horizontal Illuminance
- (4) Maximum Veiling Luminance (only for projects where lighting is being provided near the roadway; needed to determine if the drivers experience glare from the new lighting system)

Any landscaping or existing lighting must be included in the photometric calculations.

14.3.6. Parking Facilities

Lighting for parking areas should be designed in accordance with Chapter 17 of the current *RP-8*. A LLF of 0.8 must be used to compute all maintained illuminance values for LED applications. For all other light sources, a maximum LLF of 0.7 may be used.

14.3.7. Toll Plazas

Lighting for toll plazas should be designed in accordance with Chapter 15 of the current *RP-8*. A LLF of 0.8 must be used to compute all maintained illuminance values for LED applications. For all other light sources, a maximum LLF of 0.7 may be used.

14.3.8. Aesthetic Lighting

Any lighting that is being installed for purposes other than safety for the traveling public is considered aesthetic lighting. Aesthetic lighting should be designed so that it does not impair vehicular or pedestrian traffic. All aesthetic lighting shall be designed to meet illumination requirements in accordance with the appropriate preceding category in **Section 14.3.1**.

14.3.9. Permitted Lighting

Permitted Lighting consists of any lighting system installed by a local government or private entity under a utility permit. Permitted Lighting must comply with the applicable design criteria described in other sections of this chapter.

14.4. Design Criteria

14.4.1. Photometric Submittals

To design an appropriate lighting system for a project, the lighting designer must calculate the required illumination, luminance and veiling luminance for the roadway sections. Various factors need to be considered such as roadway width, lighting setback and mounting height, and the type of light source to be used. The lighting designer should exercise sound engineering judgment when determining the proper application of photometric calculations recommended in IES standards and this manual. The designer performs lighting calculations for a project by using a computer program, such as AGi32 by Lighting Analysts, Inc. Illuminance calculations shall show illuminance values on the roadway with two calculation points per lane, quarterly spaced, and point-to-point intervals of 10 ft. spaced longitudinally. Luminance calculations are done by using the quarter point technique in complete luminaire cycles, as outlined in **Figure 3-6** of the current *RP-8*.

The designer must submit the original lighting file (AGI file, for example), MicroStation design file, and a PDF photometric layout file, that includes the below information, to the Roadway Lighting Group, of the Office of Design Policy and Support.

- (1) Project name
- (2) P.I. number
- (3) Date the layout was completed.
- (4) Name of the design professional and firm responsible for developing the photometric layout.
- (5) The complete area being analyzed, along with either a summary of the necessary calculation data or a reference to the grid name within the Statistics Table. These values do not necessarily need to be legible when printed, but need to be legible when viewed electronically.
- (6) A Statistics Table showing the symbol, tabulated values for average, minimum and maximum foot-candles, uniformity and veiling luminance ratios.
- (7) Roadway classification, pedestrian conflicts and any other assumptions made when defining appropriate lighting levels.
- (8) Luminaire schedule showing symbol, quantity, catalog number, description, lamp type, light loss factors, label, file name, lumens, and watts - for each fixture used.
- (9) Luminaire location table showing the identifying fixture label, xyz coordinates, mounting height, and tilt (if applicable).

Specific requirements for the type of lighting provided can be found in **Section 14.3** of this manual. Analysis must be done for at least two (2) luminaires options, preferably three (3), if the project has any federal funding.

The photometric layout sheet(s) may be of any size deemed appropriate as it will not be included in the construction plans for the project.

It may be necessary for the lighting designer to consider other light source options to demonstrate that the lighting design is optimum and cost effective. The lighting designer should be prepared to explain the light source choice and present all documentation to GDOT to define and support the lighting recommendation. The lighting designer may be asked to provide cost estimates for construction, energy, and long term maintenance for other light sources such as high pressure sodium, metal halide, and LED type fixtures. **Where LED or other energy efficient light fixtures are an efficient alternative, they must be used.**

14.4.2. Light Standard Location

See **Chapter 5, Roadside Safety and Lateral offset to Obstructions**, of this manual for guidance regarding the location of light standards and high mast towers. In addition, light standards and high mast towers shall provide adequate clearances from utility lines, airport glide paths, railroads, etc. The lighting designer shall ensure that the design is coordinated with other utility features. Written approval from the Federal Aviation Administration (FAA) stating that the lighting design does not interfere with operations is required if (a) the lighting structure is greater than 200' in height; (b) the project is located within five (5) miles of a public use or military airport; (c) the project is located

within one (1) mile of a public use heliport; or (d) is located on a public use airport or heliport. Refer to GDOT Lighting Design Process for further guidance on FAA coordination.

Standard Roadway Lighting

Standard roadway lighting generally consists of roadway poles with typical mounting heights of between 30-ft and 50-ft and horizontally mounted luminaires mounted on mast arms. Depending on design conditions, lighting standards may be placed on either one or both sides of the roadway, placed either opposite or staggered. Tilt fixtures are highly discouraged, but if used they should be placed in a manner so that they do not present an unacceptable glare on the roadway or adjacent properties. Maximum Veiling Luminance Ratio calculations will need to be provided for verification for all layouts using tilt fixtures.

Preferably, lighting standards should be located outside of the clear zone (see **Chapter 3** of the current AASHTO Roadside Design Guide). Lighting standards located inside the clear zone shall be provided with both AASHTO compliant breakaway bases (or breakaway couplings) and breakaway wiring connectors, unless shielded by a barrier. Lighting standards may also be located on a median barrier wall. Lighting standards shall not be in a roadside ditch. Luminaires should be located behind active lanes, where they will not result in an unacceptable level of safety or service if lane closures are required for lighting maintenance.

High Mast Towers

High mast towers have a typical 100-ft nominal mounting height, but towers with higher mounting heights are acceptable. Fixtures mounted on a high mast tower should be done so to maximize the light delivered to the roadway areas and minimize the wasted light off roadway, such as in infield areas and wooded areas. Special attention should be paid to light trespass onto ROW when using high mast tower fixtures and both horizontal and vertical illuminance calculations may be requested to verify there is minimal light trespass. This is critical if the project is located within a bat habitat ESA area. The use of house side shields and perhaps counterweights may be necessary to optimize lighting designs. All high mast towers should be located outside of the clear zone.

14.4.3. Structural Requirements

Light standard foundations shall be provided by the lighting designer. High mast tower foundations are designed on a project-by-project basis. The designer should coordinate with the Office of Bridge Design and the Office of Materials to determine the level of analysis required to perform a foundation design. Soil borings shall be done at each proposed high mast pole location and these results used to design the foundation. The high mast pole foundation design requires approval by the GDOT Office of Bridge Design prior to construction of the foundation. All high mast light poles located on a 2:1 or greater slope shall include a maintenance platform.

14.4.4. Power Service

The lighting designer shall contact the power company and determine the availability of power service for the lighting system. Specifically, a request should be made to obtain power service at locations desired by the lighting designer. The lighting designer shall provide the power company with an estimated load for each service point location. A site visit with a power company representative may be necessary to coordinate power service locations.

The proposed lighting system should be metered. If the local government enters into a contract with the power company to provide power at a fixed monthly charge, metering will not be required.

The standard power services available from the power company are as follows:

- **Single phase – 3 wire:** 120/240V and 240/480V, the latter is preferred.
- **Three phase – 4 wire:** 480/277V. This power service is preferred (when available) for lighting projects with high loads.

14.4.5. Electrical Design

The electrical power distribution design shall meet the National Electrical Code (NEC) and local codes. The lighting designer should include appropriate control devices such as time clocks, lighting contactors and photocells in the design to control the lighting system. Refer to **Section 5.2.8** of the current *RP-8* for guidance on adaptive lighting.

All electrical equipment, such as main circuit breakers, lighting contactors and load centers, shall be in NEMA-4X stainless steel enclosures that can be padlocked and shall be U.L. Listed. A surge suppressor shall be provided at each power service. The surge suppressor shall be in a NEMA-4X enclosure, UL1449 and UL1283 Listed, suitable for connection to the power service. The surge suppressor shall have a minimum surge current rating of 130,000A per phase and shall be provided with status indicating lights.

The electrical equipment and power distribution system should be designed to accommodate any possible future expansion. Specifically, the electrical equipment short circuit ratings should exceed the available fault current. The lighting designer shall obtain the available fault current values from the power company.

The lighting designer shall size the cables to limit the voltage drop from the service to the end of any branch circuit to approximately 3.5%; in no case shall the voltage drop of any branch circuit from the transformer exceed 5%, in accordance with NEC. Voltage drop calculations should be submitted to GDOT for approval as part of the final plan approval.

The lighting designer shall include a diagram of each service point. See **Figure 14.2. Example of a Single-Line Diagram for a Service Point**, for an example illustrating format and content.

14.4.6. Grounding

All grounding shall be done in accordance with NEC. A grounding rod shall be provided at each conventional light pole and connected at the pole base using a ground conductor. For high mast lighting, a ground grid consisting of four ground rods at the corners of the foundation shall be provided. These rods shall be connected to each other using #2 AWG stranded copper conductor to form the square ground grid. A #2 AWG bare stranded copper conductor shall be welded exothermically to the grid and brought into the tower base to connect to the pole.

Grounding rods shall be copper clad steel, minimum $\frac{3}{4}$ -in diameter, 10-ft. long. Buried ground conductors shall be stranded copper. All underground connections for the grounding system shall be made using exothermic weld process.

For each power service location, a ground rod with a minimum of #2 AWG stranded copper conductors shall be provided. An adequately sized stranded copper conductor shall be connected to the ground grid and connected to main service disconnecting means. Appropriately sized insulated ground conductor(s) shall be provided in the conduits with branch circuitry.

14.5. Material Requirements

14.5.1. Luminaires

GDOT does not have a Qualified Products list established for luminaires at this time. The designer shall choose a specific lighting technology based on construction, energy efficiency, maintenance costs, and aesthetic and local government preferences.

The designer shall select at least two (2) luminaires, preferably three (3), which provide a photometric distribution that provides adequate roadway illumination without spillage onto adjacent properties. The fixtures selected in the photometric calculations must be specified in the final plans and should match the fixture sent with shop drawings. If a different fixture is used, a new photometric layout shall be submitted. Horizontally mounted luminaires with cut-off optics shall be used for both high mast and conventional luminaires, as required by project-specific conditions.

Shields shall be used to control light spillage on residences or other areas where the spilled light may be considered objectionable. The lighting designer needs to consider this type of impact to surrounding areas and land uses when designing a lighting system, as well as the photometric impacts of utilizing external shields.

14.5.2. Electrical Materials

All electrical materials, such as conduit, cables, wires and junction boxes, shall be U.L. listed, meet the requirements of the National Electrical Code, and the American National Standards Institute. Electrical conduits, wires, circuit breakers, fuses, ground rods and ground conductors shall meet GDOT's Standard Specifications and shall be selected from GDOT's Qualified Products List (QPL).

Intentionally Left Blank

References

Referenced Publications

This section includes reference information, descriptions of publications, and where available, links to referenced publications. Publications are listed alphabetically by source.

American Association of State Highway and Transportation Officials (AASHTO)

- A Policy on Design Standards---Interstate System, 6th Ed. (2016).
- A Policy on Geometric Design of Highways and Streets [Green Book] (2018).
- An Informational Guide on Fencing Controlled Access Highways (1990).
- Guide for High-Occupancy Vehicle (HOV) Facilities, 3rd Ed. (2004).
- Guide for Park-and-Ride Facilities, 2nd Ed., (2004).
- Guide for the Development of Bicycle Facilities, 4th Ed. (2012).
- Guide for the Planning, Design, and Operation of Pedestrian Facilities (2004).
- Guide Specifications for Horizontally Curved Steel Girder Highway Bridges (2003).
- Guidelines for Geometric Design of Low-Volume Roads 2nd Ed. (2019).
- Highway Safety Manual (2010).
- Highway-Rail Crossing Elimination and Consolidation (1995).
- LRFD Bridge Design Specifications, 8th Ed. (2017).
- Manual for Assessing Safety Hardware [MASH] 2nd Ed. (2016).
- Roadside Design Guide [RDG] 4th Ed. (2011).
- Roadway Lighting Design Guide 7th Ed. (2018).
- Standard Specifications for Highway Bridges 17th Ed (2002).

American Railway Engineering and Maintenance of Way Association (AREMA)

- Manual for Railway Engineering (2011).

Federal Highway Administration (FHWA)

- Americans with Disabilities Act (ADA) and Transportation Enhancements (TE) (2006).
- Flexibility in Highway Design (2004).
- Highway Functional Classification Concepts, Criteria and Procedures (2013).
- FRA/FHWA. Guidance On Traffic Control Devices At Highway-Rail Grade Crossings (2002).
- Handbook for Designing Roadways for the Aging Population (2014).
- FRA/FHWA. Highway-Railroad Grade Crossings: A Guide to Consolidation and Closure (1994).

- Manual on Uniform Traffic Control Devices (MUTCD) (2009).
- Mini-Roundabout Technical Summary (2010).
- Mitigation Strategies for Design Exceptions (2007).
- Noise Barrier Design Handbook (website).
- Railroad-Highway Grade Crossing Handbook, 2nd Ed. (2007).
- Roadway Lighting Handbook (2012)
- Signalized Intersections: An Informational Guide, 2nd Ed. (2013).
- Traffic Control Systems Handbook (2005).
- Updated Guidance for Functional Classification of Highways, Memorandum (Oct. 14, 2008).
- Value Engineering and The Federal Highway Administration (Website).

Georgia Department of Transportation

- Bridge and Structures Design Manual.
- Bridge and Structures Detailing Manual.
- Construction Standards and Details.
- Context Sensitive Design Online Manual.
- Design-Build Manual.
- Environmental Procedures Manual.
- Manual on Drainage Design for Highways.
- Pavement Design Manual.
- Pedestrian and Streetscape Guide.
- Plan Development Process [PDP].
- Plan Presentation Guide [PPG].
- Regulations for Driveway and Encroachment Control.
- Signal Design Guidelines.
- Signing and Marking Design Guidelines.
- Standard Specification Book.
- Utility Accommodation Policy and Standards Manual.

Georgia Soil and Water Conservation Commission (GSWCC)

- Manual for Erosion and Sediment Control in Georgia, 2016 Edition

Illuminating Engineering Society of North America (IESNA)

- Guideline for Security Lighting for People, Property and Critical Infrastructure [G-1-16] (2016)
- Lighting for Exterior Environments, RP-33-14, ANSI/IES (2014)
- Lighting Handbook, 10th Ed. (2011).
- Luminaire Classification System for Outdoor Luminaires, TM-15-11, IES (2011).
- Nomenclature and Definitions for Illumination Engineering, RP-16-10, ANSI/IES (2010).
- Recommended Practice for Design and Maintenance of Roadway and Parking Facility Lighting [RP-8-18] (2018).
- Roadway Sign Lighting [RP-19 -01] (2001).

Institute of Transportation Engineers (ITE)

- Designing Walkable Urban Thoroughfares: A Context Sensitive Approach (2010).
- Manual of Transportation Engineering Studies, 2nd Ed. (2010).
- Trip Generation, 10th Ed. (2017).
- Trip Generation Handbook, 3rd Ed. (2017).

National Association of City Transportation Officials (NACTO)

- Urban Bikeway Design Guide (2011).

National Cooperative Highway Research Program (NCHRP)

- Crossing Solutions at Roundabouts and Channelized Turn Lanes for Pedestrians with Vision Disabilities. [Report 674] (2011).
- Design Speed, Operating Speed, and Posted Speed Practices [Report 504] (2003).
- Evaluating Intersection Improvements: An Engineering Study Guide [Report 457] (2001).
- Guidance for the Selection, Use, and Maintenance of Cable Barrier Systems [Report 711] (2012).
- Recommended Procedures for the Safety Performance Evaluation of Highway Features [Report 350] (1992).
- Roundabouts: An Informational Guide, 2nd Ed. [Report 672] (2010).
- Roundabouts in the United States [Report 572] (2007).
- Safety of U-Turns at Unsignalized Median Openings [Report 524]

National Fire Protection Association (NFPA)

- National Electrical Code [NFPA-70] (2011).

Texas Transportation Institute (TTI)

- Grade Separations - When Do We Separate? Highway-Rail Crossing Conference (1999).

Transportation Research Board (TRB)

- Access Management Manual 2nd Ed. (2014).
- Highway Capacity Manual 6th Ed. (2016).

United States Access Board (Access Board)

- Proposed Guidelines for Public Rights-of-Way (PROWAG).

American Association of State Highway and Transportation Officials (AASHTO)

AASHTO. A Policy on Geometric Design of Highways and Streets (Green Book). 2018

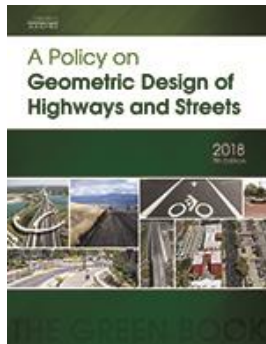

This publication may be ordered online at: https://bookstore.transportation.org/item_details.aspx?ID=1917

Notes: ISBN Number: 978-1-56051-676-7. "A Policy on Geometric Design of Highways and Streets, 7th Edition, 2018, commonly referred to as the "Green

Book," contains the current design research and practices for highway and street geometric design"...Design guidelines are included for freeways, arterials, collectors, and local roads, in both urban and rural locations, paralleling the functional classification used in highway planning.

AASHTO. A Policy on Design Standards---Interstate System, 6th Edition. 2016

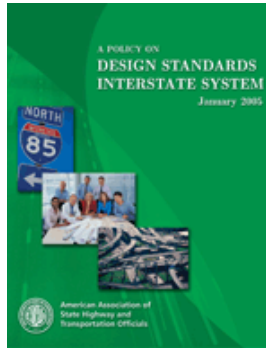

This publication may be ordered online at: https://bookstore.transportation.org/item_details.aspx?ID=2624

Notes: ISBN Number: 978-1-56051-651-4 "These standards reflect the minimum standards that apply to the Interstate highway segments constructed on new right-of-

way and segments undergoing reconstruction along existing right-of-way. These standards, which include changes based on research and practice since the previous 2005 edition, are designed for use with A Policy on Geometric Design of Highways and Streets (the "Green Book"). Design values are presented in both U.S. customary and metric units."

AASHTO. Guide for the Development of Bicycle Facilities, 4th Edition. 2012

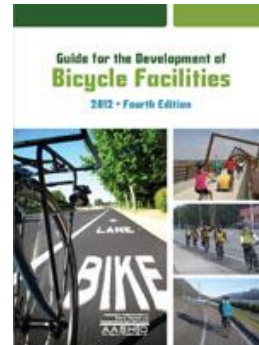

This publication may be ordered online at: https://bookstore.transportation.org/collection_detail.aspx?ID=116

Notes: This guide provides information on how to accommodate bicycle travel and operations in most riding environments. It is intended to present sound guidelines that result in facilities that meet the needs of bicyclists and other highway users. Sufficient flexibility is permitted to encourage designs that are sensitive to local context and incorporate the needs of bicyclists, pedestrians, and motorists." (AASHTO, 2012).

AASHTO. Guide for High-Occupancy Vehicle (HOV) Facilities, 3rd Edition. 2004



This publication may be ordered online at: https://bookstore.transportation.org/item_details.aspx?ID=114

Notes: ISBN Number: 1-56051-295-4 "This guide suggests methods and designs for dedicated facilities to encourage greater use of existing transportation systems, such as increased use of public transit (primarily buses), carpools, vanpools, or other ridesharing modes to help attain the above goals. Guidance is given for planning and design of preferential treatment for high-occupancy vehicles" (AASHTO, 2006).

AASHTO. Guide for Park-and-Ride Facilities, 2nd Edition. 2004



This publication may be ordered online at: https://bookstore.transportation.org/item_details.aspx?ID=121

Notes: ISBN Number: 1-56051-294-6 "Information presented in this guide is intended to provide a general knowledge of the park-and-ride planning and design process. Applicable local ordinances, design requirements, and building codes must be consulted for their affect on the planning and

design process. Local data resources, development patterns, and transit networks may present unique opportunities for park-and-ride implementation, and should be explored.

Chapter content includes: Defining the Park-and-Ride System, Park-and-Ride Planning Process, Operations and Maintenance of Park-and-Ride Facilities, Design Considerations for Park-and-Ride Facilities, and Architecture, Landscape, and Art: Integral Parts of the Park-and-Ride Facility” (AASHTO, 2006).

AASHTO. Guide for the Planning, Design, and Operation of Pedestrian Facilities. 2004

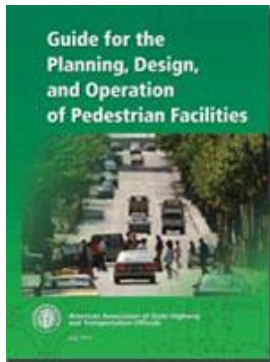

This publication may be ordered online at: https://bookstore.transportation.org/item_details.aspx?id=119

Notes: The purpose of this guide is to provide guidance on the planning, design, and operation of pedestrian facilities along streets and highways. Specifically, the guide focuses on identifying

effective measures for accommodating pedestrians on public rights-of-way.

AASHTO. Guidelines for Geometric Design of Low-Volume Roads, 2nd Ed.. 2019

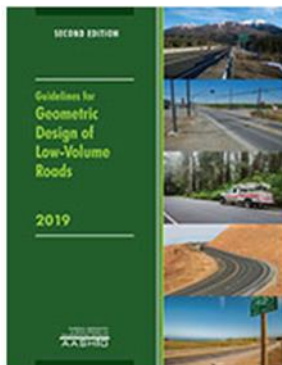

This publication may be ordered online at: https://bookstore.transportation.org/item_details.aspx?ID=157

Notes: “[This publication] addresses the unique design issues highway designers and engineers face when determining appropriate cost-effective geometric design policies

for low-volume local roads. This approach covers both new and existing construction projects. Because geometric design guidance for very low-volume local roads differs from the policies applied to high-volume roads, these guidelines may be used in lieu of *A Policy on Geometric Design of Highways and Streets*, also known as the *Green Book*” (AASHTO, 2018).

AASHTO. Highway-Rail Crossing Elimination and Consolidation. 1995

Additional information regarding this publication is

available online at:

<http://safety.transportation.org/prgpub.aspx?pid=1855>

Notes: Explains the purpose and benefits of crossing consolidation from a national and local perspective, and from a highway and railroad perspective.

AASHTO. Highway Safety Manual. 2010.

This publication may be ordered online at:

https://bookstore.transportation.org/collection_detail.aspx?ID=135



Notes: The Highway Safety Manual (HSM) was developed to help measurably reduce the frequency and severity of crashes on American roadways by providing tools for considering safety in the project development process. The HSM assists practitioners in selecting countermeasures and prioritizing projects, comparing alternatives, and quantifying and predicting the safety performance of roadway elements considered in planning, design, construction, maintenance, and operation. (AASHTO, 2012).

AASHTO. Manual for Assessing Safety Hardware [MASH]. 2nd Ed. 2016.

This publication may be ordered online at:

https://bookstore.transportation.org/collection_detail.aspx?ID=34

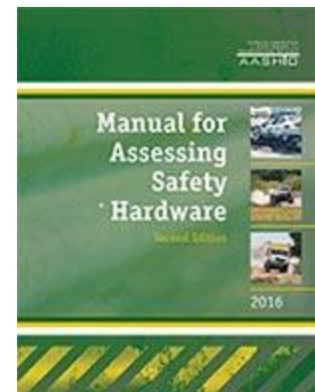

Notes: The purpose of this report is to present uniform guidelines for the crash testing of both permanent and temporary highway safety features and recommended evaluation criteria to assess test results. MASH is an update to and supersedes NCHRP Report 350, Recommended Procedures for the Safety Performance Evaluation of Highway Features, for the purposes of evaluating new safety hardware devices. MASH does not supersede any guidelines for the design of roadside safety hardware, which are contained within the AASHTO Roadside Design Guide (AASHTO, 2012).

AASHTO. Roadside Design Guide, 4th Edition. 2011.

This publication may be ordered online at:
https://bookstore.transportation.org/collection_detail.aspx?ID=105

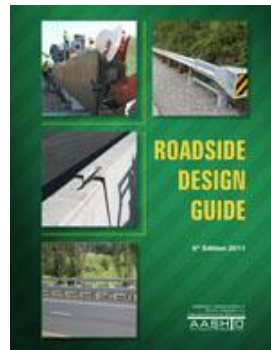

Notes: “ The 2011 edition of the AASHTO Roadside Design Guide has been updated to include hardware that has met the evaluation criteria contained in the National Cooperative Highway Research Program (NCHRP) Report 350: Recommended Procedures for the Safety Performance Evaluation of Highway Features and begins to detail the most current evaluation criteria contained under the Manual for Assessing Safety Hardware, 2009 (MASH).” Refer to the February 2012 errata. (AASHTO, 2012).

AASHTO. Roadway Lighting Design Guide. 7th Edition. 2018



This publication may be ordered online at:
https://bookstore.transportation.org/item_details.aspx?ID=1412

Notes: [GL-6] This guide replaces the 1984 publication entitled An Informational Guide for Roadway Lighting. It has been revised and brought up to date to reflect current practices in

roadway lighting. The guide provides a general overview of lighting systems from the point of view of the transportation departments and recommends minimum levels of quality. The guide incorporates the illuminance and luminance design methods, but does not include the small target visibility (STV) method.

AASHTO. Standard Specifications for Highway Bridges, 17th Edition. 2002

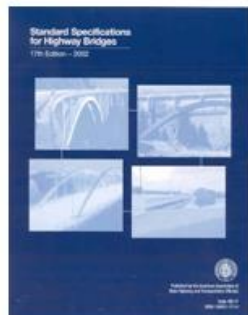

Additional information regarding this publication is available online at:
<https://store.transportation.org/Item/CollectionDetail?ID=15>

Notes: The Standard Specifications for Highway Bridges, 17th edition is for the maintenance and rehabilitation of structures designed under its

governance as well as the design of new local bridges as allowed by the Bridge and Structures Design Manual. This document is superseded by the AASHTO LRFD Bridge Design Specifications, 8th Edition for most new bridges and structures.

AASHTO. LRFD Bridge Design Specifications, 8th Edition. 2017

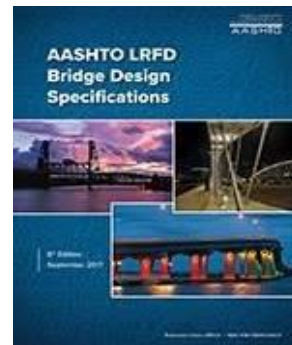

This publication may be ordered online at:
<https://store.transportation.org/Item/PublicationDetail?ID=3888>

Notes: The LRFD Bridge Design Specifications, 8th Edition (2017) is for the design, maintenance, and rehabilitation of most structures with Preliminary Engineering authorization date on or after October 1,

2017, unless allowed otherwise by the Bridge and Structures Design Manual.

American Railway Engineering and Maintenance of Way Association (AREMA)

AREMA. Manual for Railway Engineering. 2012

Notes: A new manual is published each year. The full manual or individual chapters may be ordered online through AREMA at
<http://www.arema.org/publications/mre/index.aspx>

Federal Highway Administration (FHWA)

FHWA. Americans with Disabilities Act (ADA) and Transportation Enhancements (TE). 2006

Visit the following FHWA web page for additional information relating to Americans with Disabilities Act (ADA) requirements:
http://www.fhwa.dot.gov/environment/transportation_enhancements/guidance/te_ada.cfm

FHWA. Flexibility in Highway Design. 2004

Available online at:
<http://www.fhwa.dot.gov/environment/flex/>

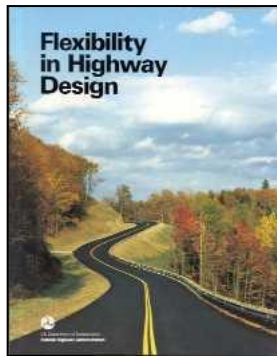

FRA/FHWA. Guidance on Traffic Control Devices at Highway-Rail Grade Crossings. 2002

Available online at:
<http://safety.fhwa.dot.gov/intersection/resources/fhwas09027/resources/Guidance%20On%20Traffic%20Control%20at%20Highway%20Rail%20Grade.pdf>

FRA/FHWA. Highway-Railroad Grade Crossings: A Guide to Consolidation and Closure. 1994

Information regarding this publication is available online at:
http://www.fra.dot.gov/downloads/safety/hwyr_xings_guide.pdf

FHWA. Roadway Lighting Handbook. 1978

Notes: Implementation Package 78-15. Reprinted April 1984. Washington, D.C.

FHWA. Manual on Uniform Traffic Control Devices (MUTCD). 2009

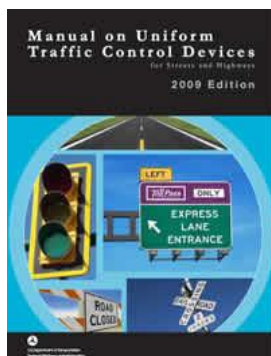

Available online at:
http://mutcd.fhwa.dot.gov/pdfs/2009/pdf_index.htm

FHWA. Mitigation Strategies for Design Exceptions. 2007.

Available online at:



http://safety.fhwa.dot.gov/geometric/pubs/mitigationstrategies/fhwa_sa_07011.pdf

Notes: Mitigation Strategies for Design Exceptions was developed to provide designers with practical information on design exceptions and strategies that can be implemented to mitigate their potential adverse impacts to highway safety and traffic operations. (FHWA).

FHWA. Railroad-Highway Grade Crossing Handbook, 2nd Edition. 2007.

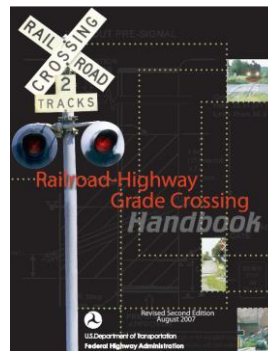

Available online at:
<http://www.ite.org/decade/pubs/TB-019-E.pdf>

FHWA. Value Engineering and The Federal Highway Administration (Website).

Available online at:
<http://www.fhwa.dot.gov/ve/index.cfm>

Georgia Department of Transportation

GDOT. Bridge and Structures Design Manual.

Available on the GDOT Repository for Online Access to Documentation and Standards (R.O.A.D.S.) website at:
<http://www.dot.ga.gov/PartnerSmart/DesignManuals/BridgeandStructure/GDOT Bridge and Structures Policy Manual.pdf>

GDOT. Manual on Drainage Design for Highways.

Available on the GDOT Repository for Online Access to Documentation and Standards (R.O.A.D.S.) website at:
<http://www.dot.ga.gov/PartnerSmart/DesignManuals/Drainage/Drainage%20Manual.pdf>

GDOT. Construction Standards and Details.

Available on the GDOT Repository for Online Access to Documentation and Standards (R.O.A.D.S.) website at: http://standarddetails.dot.ga.gov/stds_dtls/

GDOT. GDOT Context Sensitive Design Online Manual, Version 1.0.

Available on the GDOT Repository for Online Access to Documentation and Standards (R.O.A.D.S.) website at:

http://www.dot.ga.gov/PartnerSmart/DesignManuals/ContextSensitiveDesign/GDOT_CSD_Manual.pdf



GDOT. Environmental Procedures Manual.

Available on the GDOT Repository for Online Access to Documentation and Standards (R.O.A.D.S.) website at: <http://www.dot.ga.gov/PartnerSmart/DesignManuals/Environmental/GDOT-EPM.pdf>

GDOT. Pavement Design Manual.

Available on the GDOT Repository for Online Access to Documentation and Standards (R.O.A.D.S.) website at:

<http://www.dot.ga.gov/PartnerSmart/DesignManuals/Pavement/Pavement%20Design%20Manual.pdf>

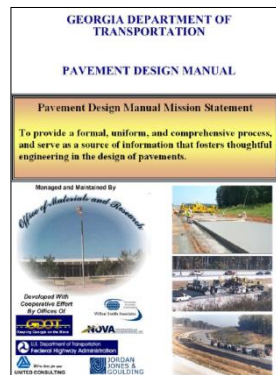

Notes: Provides guidance for developing the history and necessary information that may be needed in designing both a rigid and flexible pavement structure.

GDOT. Pedestrian and Streetscape Guide.

Available online at: <http://www.dot.ga.gov/PartnerSmart/DesignManuals/TrafficOps/GDOT%20Pedestrian%20and%20Streetscape%20Guide.pdf>

Provides direction to design professionals, developers, municipalities and others regarding the design, construction, and maintenance of pedestrian facilities. The Guide will also aid in continuing to address the goals put forth in GDOT's 1995 Bicycle and Pedestrian Plan.

GDOT. Plan Development Process (PDP).

Available on the GDOT Repository for Online Access to Documentation and Standards (R.O.A.D.S.) website at: <http://www.dot.ga.gov/PartnerSmart/DesignManuals/Plan/PDP.pdf>

GDOT. Plan Presentation Guide.

Available on the GDOT Repository for Online Access to Documentation and Standards (R.O.A.D.S.) website at: http://www.dot.ga.gov/PartnerSmart/DesignManuals/Plan/Plan_Presentation_Guide.pdf

GDOT. Regulations for Driveway and Encroachment Control.

Available on the GDOT Repository for Online Access to Documentation and Standards (R.O.A.D.S.) website at: <http://www.dot.ga.gov/PartnerSmart/DesignManuals/Encroachment/DrivewayFull.pdf>

GDOT regulations, which are developed as guidelines for the maximum protection of the public through orderly control of traffic entering and leaving a part of the State highway system, updated October 2006.

GDOT. Standard Specification Book.

Available online at: http://www.dot.ga.gov/PartnerSmart/Business/Documents/Suppl_Specification_2008_Book.pdf

The order form for this and other specification publications may be downloaded from: <http://tomcat2.dot.state.ga.us/ContractsAdministration/loads/availpub.PDF>

GDOT. Signal Design Guidelines.

Published by the GDOT Office of Traffic Safety and Design. Available on the GDOT Repository for Online Access to Documentation and Standards (R.O.A.D.S.) website at: <http://www.dot.ga.gov/PartnerSmart/DesignManuals/SignalDesignManual/Traffic%20Signal%20Design%20Guidelines.pdf>

GDOT. Utility Accommodation Policy and Standards Manual.

Available online at: http://www.dot.ga.gov/PartnerSmart/utilities/Documents/2009_UAM.pdf

Contains the current policy of the Georgia DOT Office of Utilities regarding utility accommodation on the public highway right-of-way.

Georgia Soil and Water Conservation Commission (GSWCC)

Georgia Soil and Water Conservation Commission. Manual for Erosion and Sediment Control in Georgia, 2016.

Entire document (note: this is a 47.9 megabyte file, and will take several minutes to load on a high-speed Internet connection):
http://gaswcc.georgia.gov/sites/gaswcc.georgia.gov/files/related_files/site_page/GSWCC-2016-Manual-As-Approved-by-Overview-Council.pdf

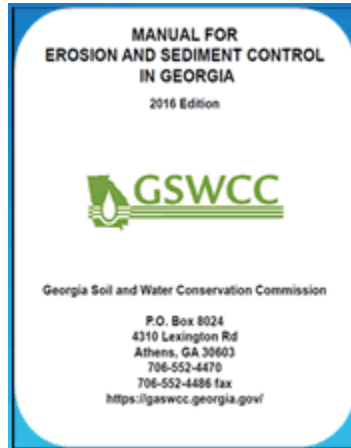

IESNA. Lighting for Exterior Environments (RP-33-14). 2014

Publication may be ordered online through IES at:
<http://www.ies.org/store/product/recommended-practice-for-the-economic-analysis-of-lighting-1360.cfm>

The intent of this Recommended Practice is to address the design issues related to outdoor lighting. It also outlines the environmental considerations of outdoor lighting especially related to sky glow and light trespass. In addition, this RP provides information on how to assign lighting zones. Finally, this RP discusses community based design, and specific recommendations for lighting outdoor areas.



Illuminating Engineering Society of North America (IESNA)

IESNA. Guideline for Security Lighting for People, Property and Critical Infrastructure (G-1-16). 2003

Publication may be ordered online through IES at:
<https://www.ies.org/product/security-lighting-for-people-property-and-critical-infrastructure/>

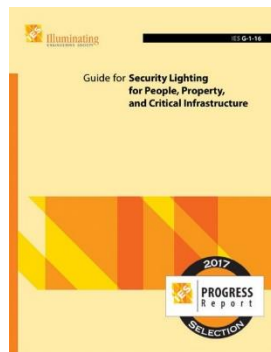

guidance for designing security lighting systems for new facilities and for evaluation and retrofitting of existing facilities and systems in response to known or perceived threats. This standard is for the use of property owners and managers, crime prevention specialists, law enforcement and security professionals, risk managers, lighting specifiers, contractors, homeowners, and those responsible for the protection of critical infrastructure who are concerned about security and the detection and prevention of crime and terrorism. Specific sections deal with critical infrastructure and homeland security. In addition, since the appearance, many of the lessons learned and applied by these agencies have been incorporated throughout.

IESNA. Lighting Handbook, 10th Edition. 2011

Publication may be ordered online through IES at:
<https://www.ies.org/handbook/>

Referred to by industry professionals as the "Bible of Lighting." This comprehensive reference includes explanations of concepts, techniques, applications, procedures and systems, as well as detailed definitions, tasks, charts and diagrams.



IESNA. Luminaire Classification System for Outdoor Luminaires (TM-15-11). 2011



Publication may be ordered online through IESNA at:
<https://www.ies.org/store/product/luminaire-classification-system-for-outdoor-luminaires-1103.cfm>

This Technical Memorandum defines a classification system for outdoor luminaires that provides information to lighting professionals regarding the lumen distribution within solid angles of specific interest. The lumens within these solid angles are intended to be one of the metrics used to evaluate luminaire optical distribution including the potential for light pollution and obtrusive light, but not as the only metric that should be evaluated. Light

pollution and obtrusive light result not only from the optical characteristics of the luminaires, but also from the application of those luminaires within an outdoor site or roadway. A detailed evaluation of the lighting performance for the outdoor site should be based not only on the luminaire optics, but also on overall system design, including luminaire locations, utilization of light where it is needed, lighting quality, visual tasks, aesthetics, safety requirements, and security issues.

IESNA. Nomenclature and Definitions for Illuminating Engineering (RP-16-10). 2010

Publication may be ordered online through IESNA at: <https://www.ies.org/store/product/nomenclature-and-definitions-for-illuminating-engineeringbr-rp1605-1013.cfm>



IESNA. Recommended Practice for Design and Maintenance of Roadway and Parking Facility Lighting (RP-8-18). 2018

Publication may be ordered online through IES at: <https://www.ies.org/product/american-national-standard-practice-for-design-and-maintenance-of-roadway-and-parking-facility-lighting/>

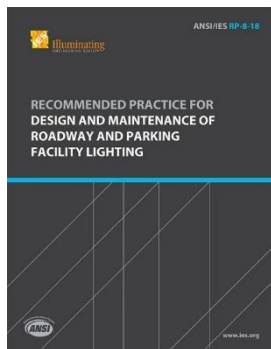

This Recommended Practice is a compilation of lighting design techniques and criteria, all offered for quality roadway lighting solutions. This document was prepared with the objective of providing lighting design guidance for most kinds of roadway and roadway-related applications. The contents of this document

are based upon a consensus of roadway lighting experts.

IESNA. Roadway Sign Lighting (RP-19 -01). 2001

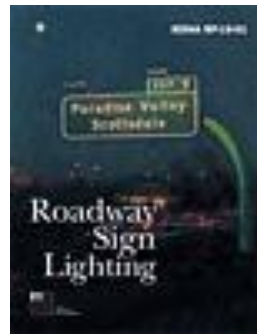

Publication may be ordered online through IESNA at: http://www.techstreet.com/cgi-bin/detail?product_id=926898

A guideline that discusses elements of roadway sign lighting, both internally and externally lighted signs, as well as maintenance factors, sign surface reflectance and color change considerations.

Institute of Transportation Engineers (ITE)

ITE. Designing Walkable Urban Thoroughfares: A Context Sensitive Approach

Available online at: <http://library.ite.org/pub/e1cff43c-2354-d714-51d9-d82b39d4dbad>



Notes: This report has been developed in response to widespread interest for improving both mobility choices and community character through a commitment to creating and enhancing walkable communities. Many agencies will work towards these goals using the concepts and principles in this report to ensure the users, community and other key factors are considered in the planning and design processes used to develop walkable urban thoroughfares. (ITE, 2012)

ITE. Manual of Uniform Transportation Engineering Studies. 2nd Edition 2010

Additional information and order forms for this publication are available online at: <http://ecommerce.ite.org/IMIS/ItemDetail?iProductCode=TB-012A>

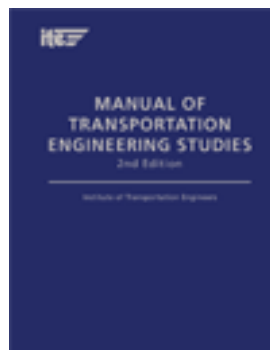

Notes: “Shows in detail how to conduct several transportation engineering studies in the field. Discusses experimental design, survey design, statistical analyses, data presentation techniques, and report writing concepts. Provides guidelines for both oral and written presentation of study results. Includes useful forms for various

transportation studies.

ITE. Trip Generation, 10th Edition. 2017

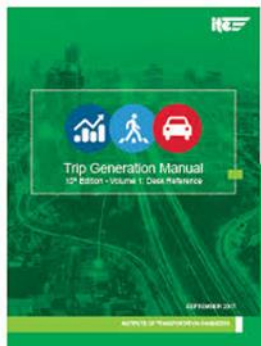

Additional information and order forms for this publication are available online at: <https://www.ite.org/technical-resources/topics/trip-and-parking-generation/trip-generation-10th-edition-formats/>

NCHRP. Evaluating Intersection Improvements: An Engineering Study Guide [Report 457]. 2001

An enhanced online version of the report is available at <http://onlinepubs.trb.org/onlinepubs/nchrp/esg/esg.pdf>



National Association of City Transportation Officials

NACTO. Urban Bikeway Design Guide. 2011



Available online at: <http://nacto.org/cities-for-cycling/design-guide/>

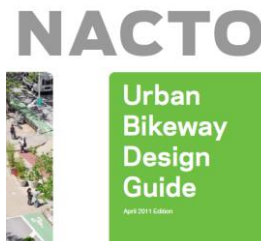

Notes: The designs in this document were developed by cities for cities, since unique urban streets require innovative solutions. Most of these treatments are not directly referenced in the current versions of the AASHTO Guide to Bikeway

Facilities or the Manual on Uniform Traffic Control Devices (MUTCD), although many of the elements are found within these documents. The Federal Highway Administration has recently posted information regarding [approval status](#) of various bicycle related treatments not covered in the MUTCD, including many of the treatments provided in the NACTO Urban Bikeway Design Guide. (NACTO, 2012)

NCHRP. Recommended Procedures for the Safety Performance Evaluation of Highway Features [Report 350]. 1992

This document is no longer in print, but may be accessed through the following link: http://onlinepubs.trb.org/onlinepubs/nchrp/nchrp_rpt_350-a.pdf

NCHRP. Roundabouts: An Informational Guide [Report 672]. 2010

Available online at: <http://www.trb.org/Main/Blurbs/164470.aspx>

National Fire Protection Association (NFPA)

NFPA. National Electrical Code [NFPA-70]. 2010

Publication may be ordered online at: <http://www.nfpa.org/catalog/product.asp?pid=7011SB&order%5Fsrc=B484&cookie%5Ftes t=1>

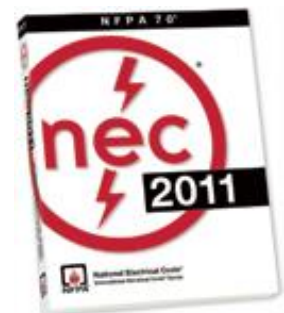

Notes: This Code covers the installation of electrical conductors, equipment, and raceways; signaling and communications conductors, equipment, and raceways; and optical fiber cables and raceways for: (1) Public and private premises, including buildings, structures, mobile homes, recreational vehicles, and floating buildings (2) Yards, lots, parking lots, carnivals, and industrial substations FPN to (2).

National Cooperative Highway Research Program (NCHRP)

NCHRP. Design Speed, Operating Speed, and Posted Speed Practices [Report 504]. 2003

Available online at: http://onlinepubs.trb.org/onlinepubs/nchrp/nchrp_rpt_504.pdf

Texas Transportation Institute (TTI)

TTI. Grade Separations - When Do We Separate? Highway-Rail Crossing Conference. 1999

Available online through the Texas Transportation Institute at: <http://tti.tamu.edu/publications/catalog/>

United States Access Board (Access Board)

Proposed Guidelines for Public Rights-of-Way (PROWAG)

Available online at: <http://www.access-board.gov/prowac/nprm.pdf>

Transportation Research Board (TRB)

TRB. Access Management Manual. 2nd Edition, 2014

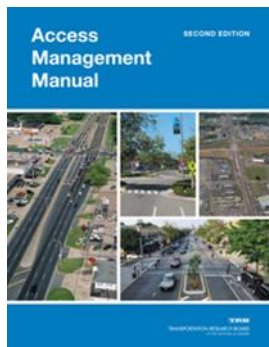

Available online at: <http://www.trb.org/Main/Blurbs/152653.aspx>

Notes: TRB's Access Management Manual provides technical information on access management techniques, together with information on how access management programs can be effectively

developed and administered. It presents access management -- the systematic control of the location, spacing, design, and operation of driveways, median openings, interchanges, and street connections to a roadway -- comprehensively, in an effort to integrate planning and engineering practices with the transportation and land use decisions that contribute to access outcomes.

TRB. Highway Capacity Manual. 6th Edition, 2016

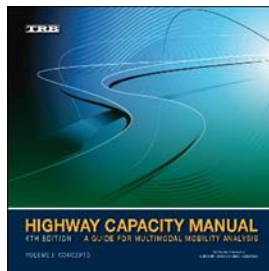

This publication may be ordered online at: <http://www.trb.org/Main/Blurbs/164718.aspx>

Notes: This latest edition significantly updates the methodologies that engineers and planners use to assess the traffic and

environmental effects of highway projects. Serves as fundamental reference on concepts, performance measures, and analysis techniques for evaluating the multimodal operation of streets, highways, freeways, and off-street pathways.



Intentionally Left Blank